

US00D549636S

(12) **United States Design Patent**  
**Dial**

(10) **Patent No.:** **US D549,636 S**

(45) **Date of Patent:** **\*\* Aug. 28, 2007**

(54) **PERSONAL WATERCRAFT**

6,748,894 B1 6/2004 Dunn et al.  
D512,678 S \* 12/2005 Mah ..... D12/308

(76) Inventor: **Franklin Dial**, 817 Ard Rd., Samson,  
AL (US) 36447

**FOREIGN PATENT DOCUMENTS**

(\*\*) Term: **14 Years**

GB 2270282 9/1994

\* cited by examiner

(21) Appl. No.: **29/257,886**

*Primary Examiner*—Holly H. Baynham  
*Assistant Examiner*—Cynthia M. Chin  
(74) *Attorney, Agent, or Firm*—Welsh & Katz, Ltd.

(22) Filed: **Apr. 13, 2006**

(51) **LOC (8) Cl.** ..... **12-06**

(52) **U.S. Cl.** ..... **D12/300**

(58) **Field of Classification Search** ..... D12/300,  
D12/305, 308, 317; 114/312, 314, 315, 337,  
114/330, 331; D21/545

(57) **CLAIM**

See application file for complete search history.

The ornamental design for a personal watercraft, as shown and described.

**DESCRIPTION**

(56) **References Cited**

FIG. 1 is a perspective view of a personal watercraft showing my new design;

**U.S. PATENT DOCUMENTS**

FIG. 2 is a front elevational view thereof;

3,466,798 A	9/1969	Speers et al.	
3,650,234 A	3/1972	Goudy	
D242,615 S *	12/1976	Henning	D12/308
D323,808 S *	2/1992	DeSantis	D12/308
5,158,034 A *	10/1992	Hsu	114/315
5,399,111 A	3/1995	Kobayashi et al.	
D359,022 S *	6/1995	Lashman	D12/308
5,704,817 A	1/1998	Vaughn	
5,988,096 A	11/1999	Benesch et al.	
D453,726 S *	2/2002	Dunn et al.	D12/308
D471,506 S *	3/2003	Mah	D12/308
6,615,761 B2	9/2003	Wyman	
6,665,789 B1	12/2003	Stecker et al.	

FIG. 3 is a top view thereof;

FIG. 4 is a left side elevational view with the right side being a mirror image thereof;

FIG. 5 is a bottom view thereof; and,

FIG. 6 is a rear elevational view thereof.

The broken lines showing a scuba diver in FIG. 4 are for demonstrative purposes only and form no part of the claimed design.

**1 Claim, 2 Drawing Sheets**

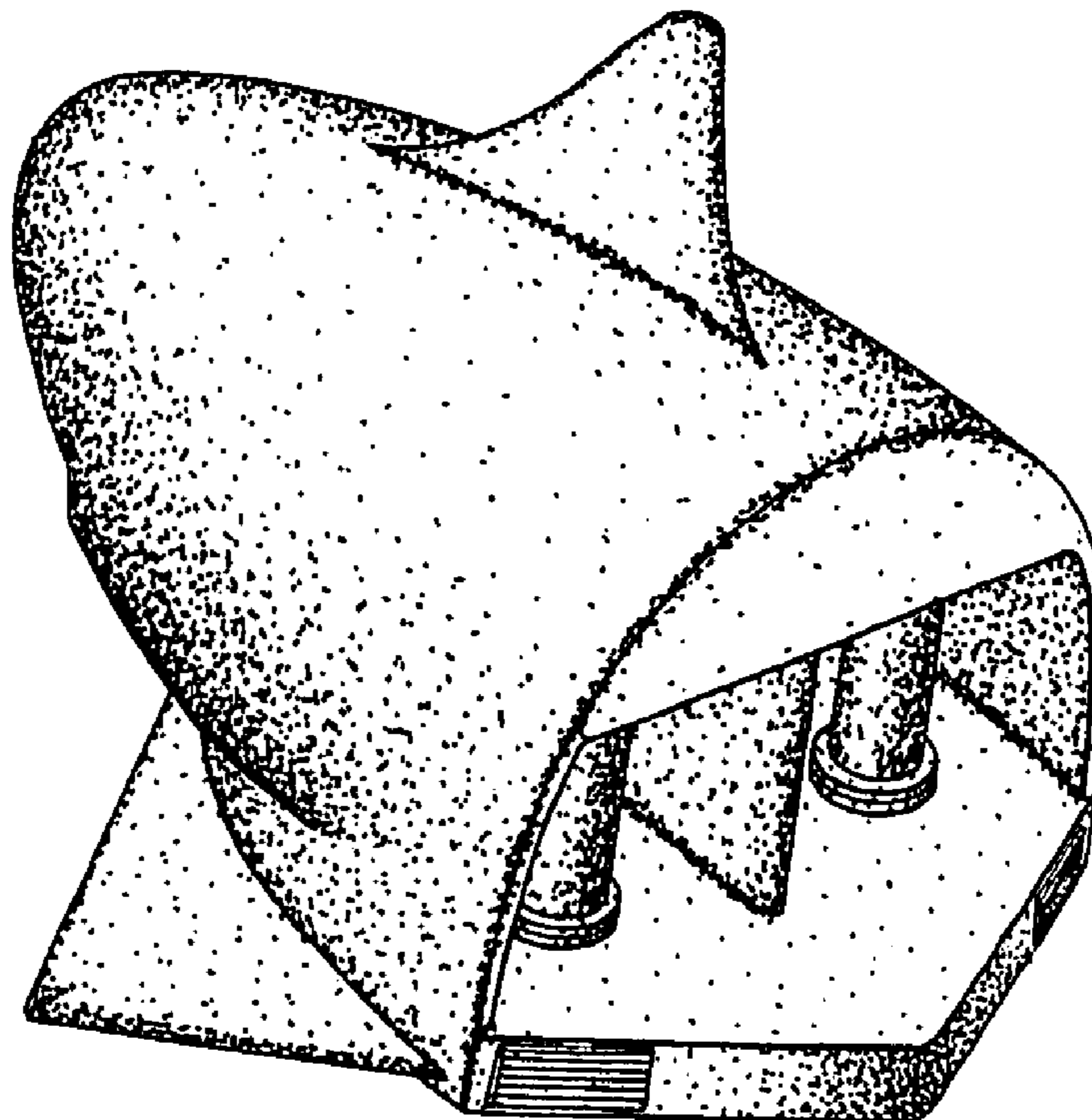

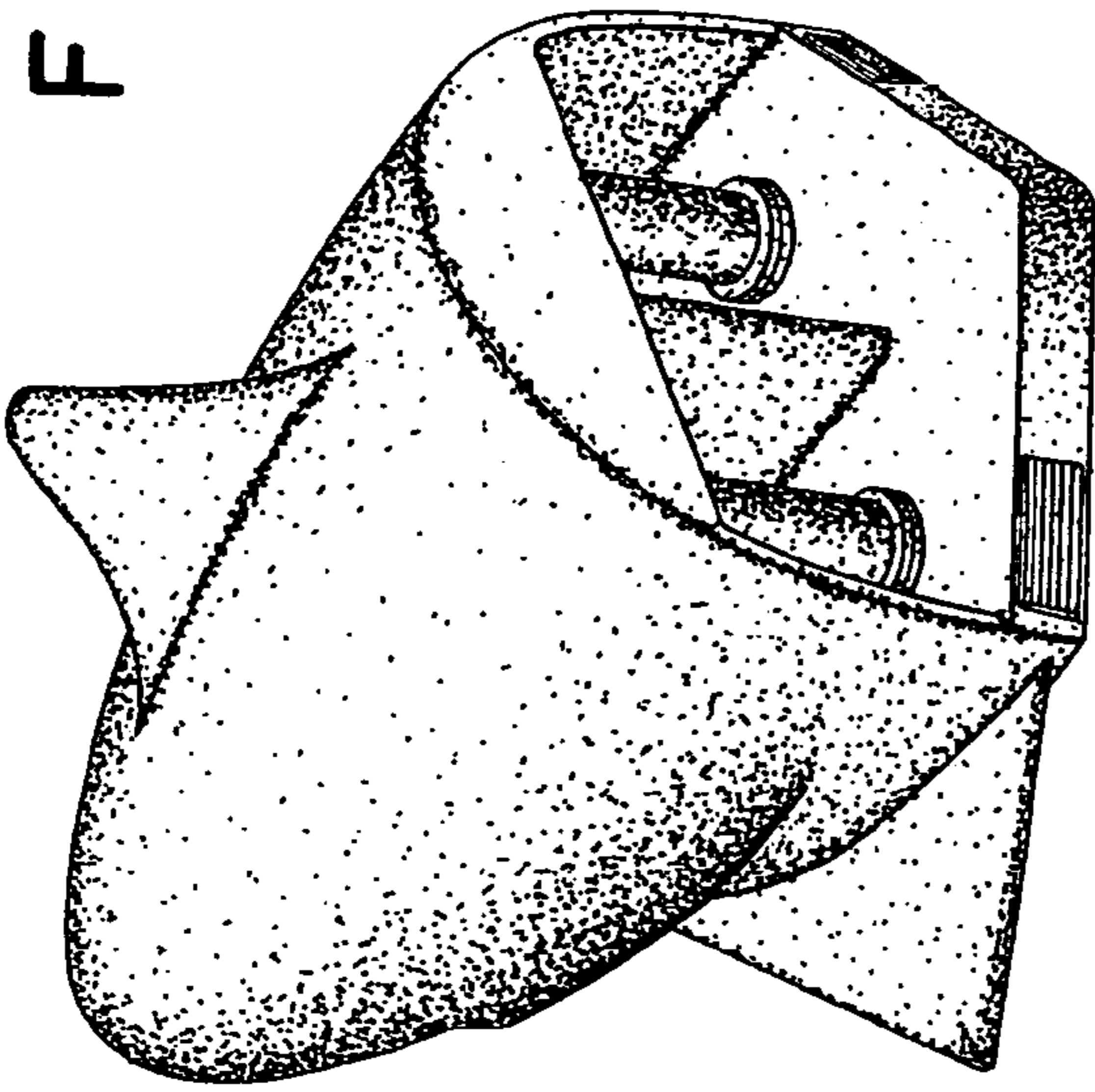

FIG. 1

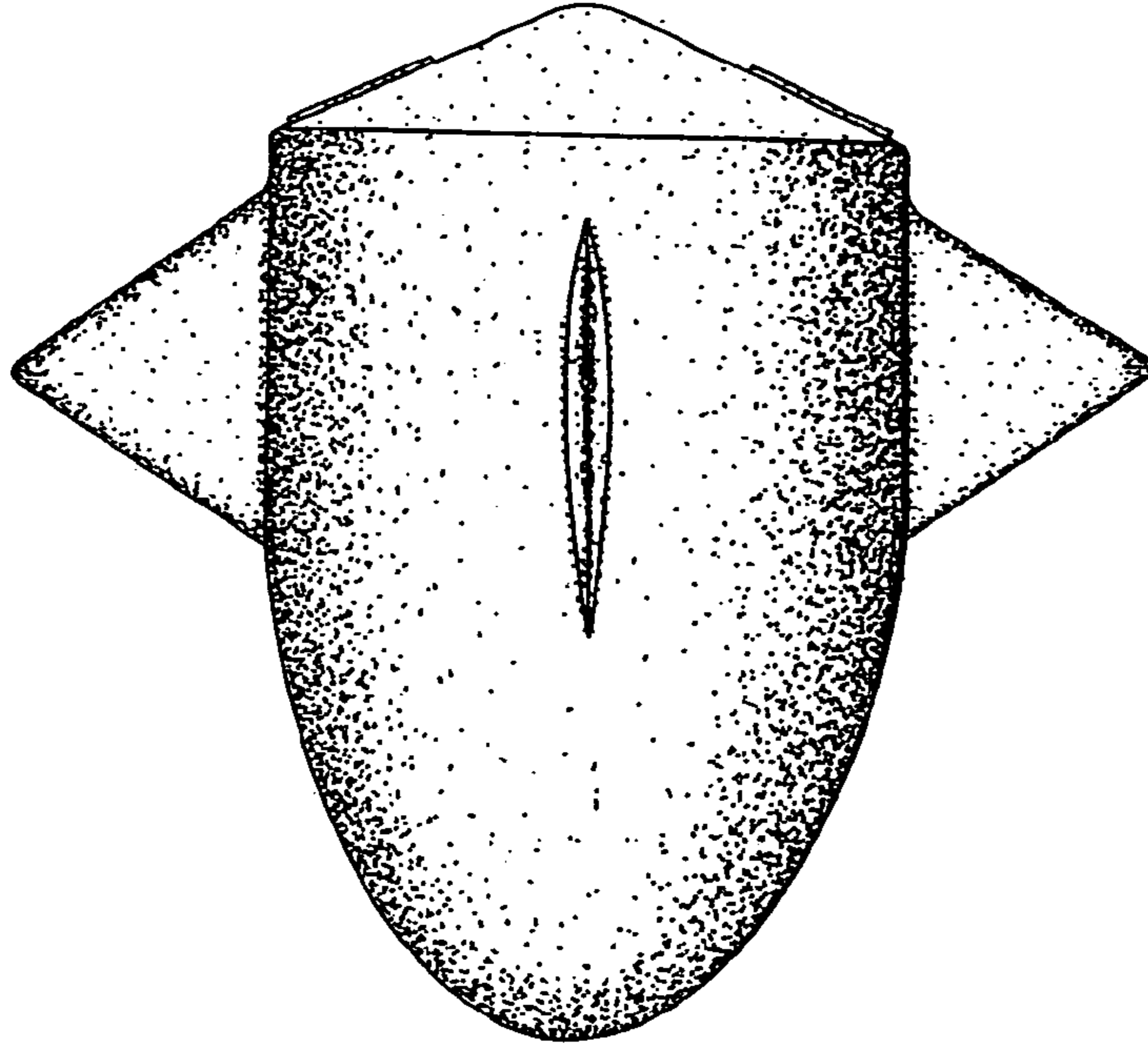

FIG. 3

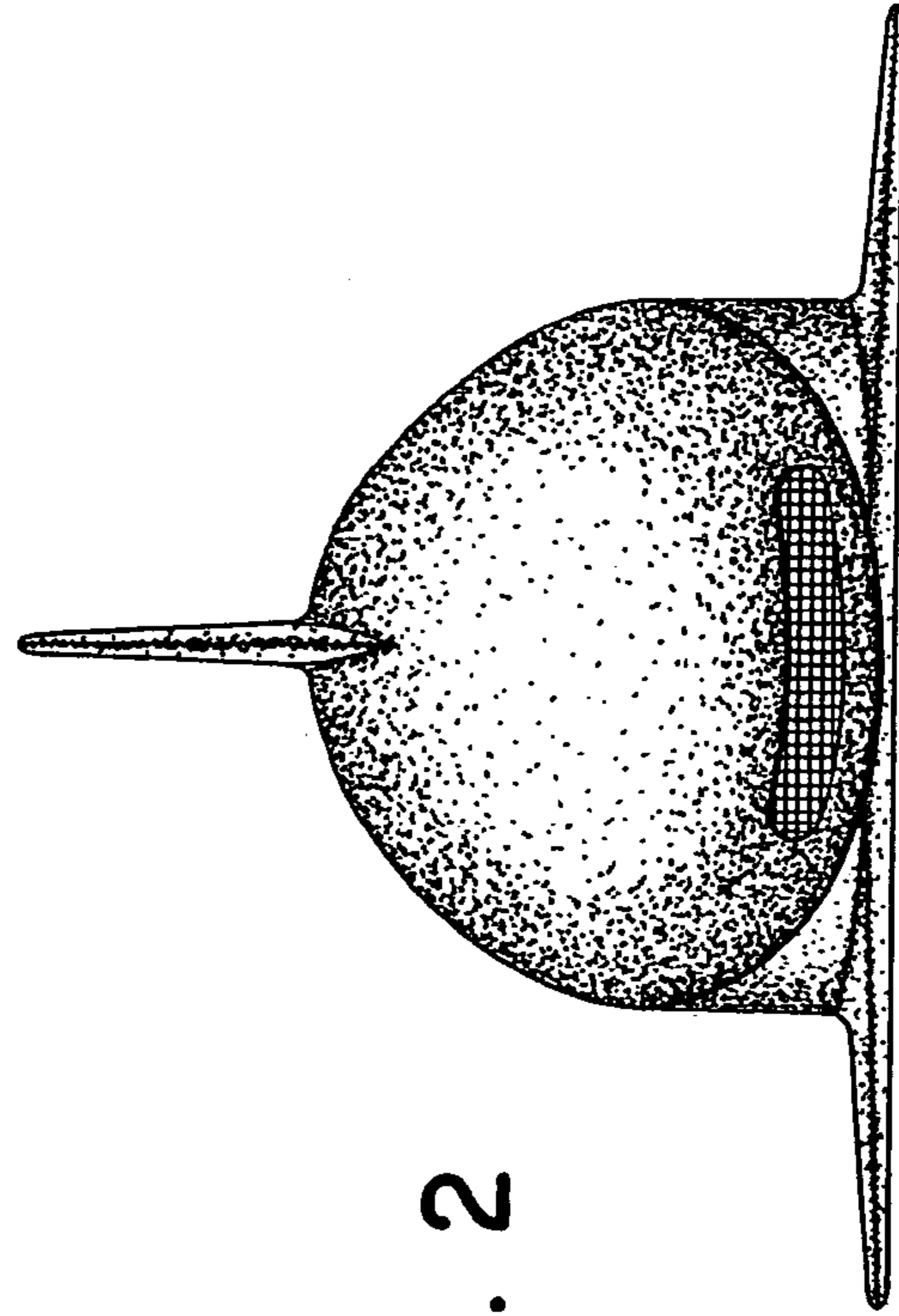

FIG. 2

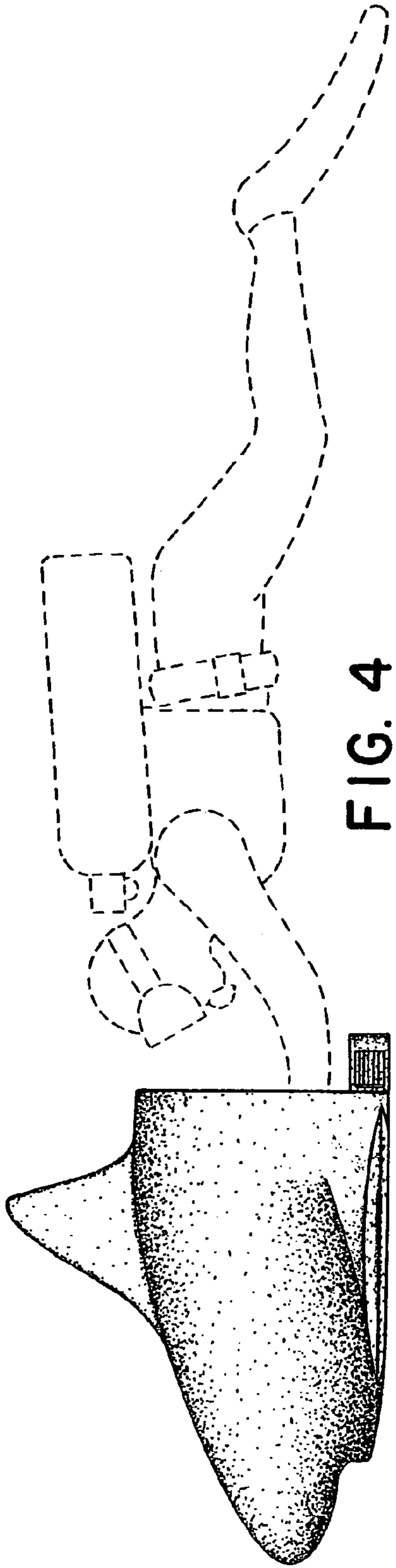

FIG. 4

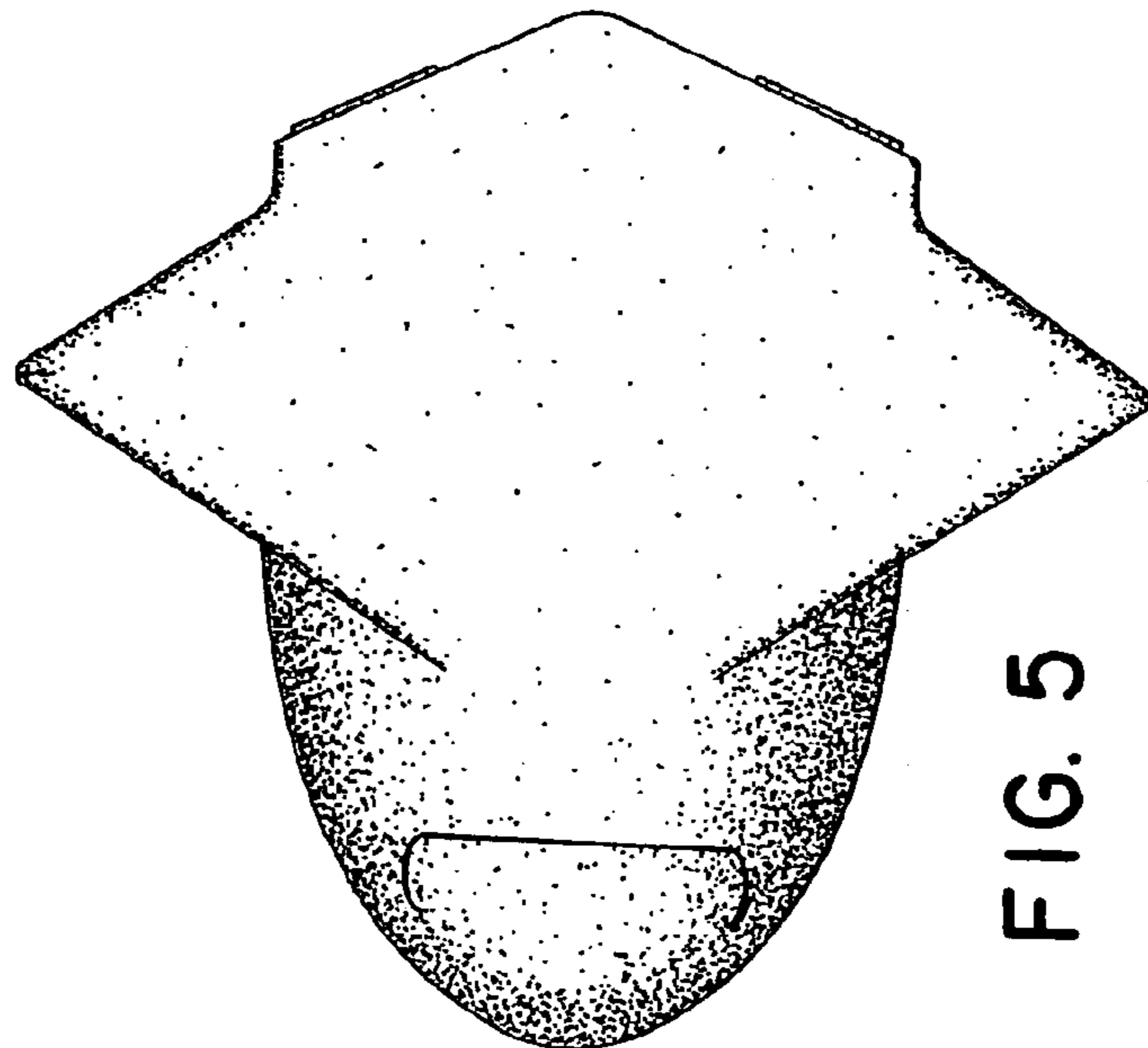

FIG. 5

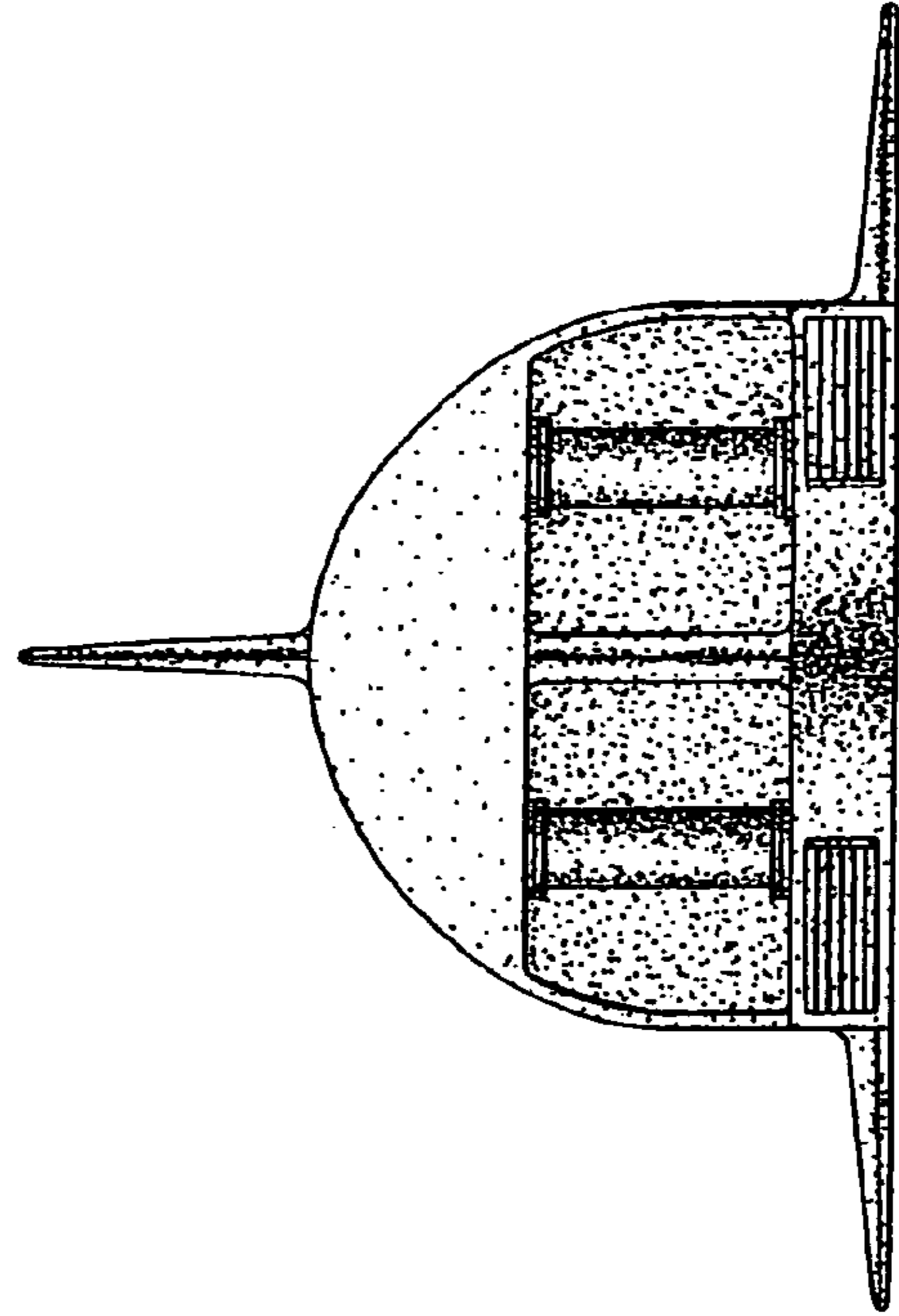

FIG. 6