



US00D549599S

(12) **United States Design Patent**
Gruosi

(10) **Patent No.:** **US D549,599 S**

(45) **Date of Patent:** **** Aug. 28, 2007**

(54) **WATCH CASE**

(75) **Inventor:** **Fawaz Gruosi**, Prangins (CH)

(73) **Assignee:** **DE Grisogono S.A.**, Plan-les-Ouates (CH)

(**) **Term:** **14 Years**

(21) **Appl. No.:** **29/264,734**

(22) **Filed:** **Aug. 17, 2006**

(30) **Foreign Application Priority Data**

Feb. 17, 2006 (CH) 132609

(51) **LOC (8) Cl.** **10-02**

(52) **U.S. Cl.** **D10/38**

(58) **Field of Classification Search** D10/30-39,
D10/123-126; 368/276, 277, 281, 282, 285,
368/223, 228, 232, 21, 28, 80, 29-30, 82-84,
368/239-242

See application file for complete search history.

(56) **References Cited**

U.S. PATENT DOCUMENTS

D93,390	S	*	9/1934	Graef	D10/39
3,162,007	A	*	12/1964	Parmentier	368/281
D211,814	S	*	7/1968	Barlow	D10/39
D352,471	S	*	11/1994	Besson	D10/39
D366,216	S	*	1/1996	Bulgari	D10/39
D382,211	S	*	8/1997	Bodino	D10/30

D387,674	S	*	12/1997	Papiernik	D10/30
D397,944	S	*	9/1998	Bulgari	D10/39
D402,567	S	*	12/1998	Gueit	D10/32
D417,628	S	*	12/1999	Bunz	D10/39
D432,433	S	*	10/2000	Bruni	D10/30
D526,215	S	*	8/2006	Calvani	D10/38
D526,913	S	*	8/2006	Calvani	D10/39
D527,286	S	*	8/2006	Calvani	D10/39

* cited by examiner

Primary Examiner—Lucy Lieberman

(74) *Attorney, Agent, or Firm*—Young & Thompson

(57) **CLAIM**

The ornamental design for a watch case, as shown.

DESCRIPTION

FIG. 1 is a top and side perspective view of a watch case showing my new design;

FIG. 2 is a top plan view thereof;

FIG. 3 is a side elevational view thereof from the left of FIG. 2;

FIG. 4 is a side elevational view thereof from the right of FIG. 2;

FIG. 5 is a view thereof from the top of FIG. 2;

FIG. 6 is a view thereof from the bottom of FIG. 2; and,

FIG. 7 is a bottom plan view thereof.

1 Claim, 2 Drawing Sheets

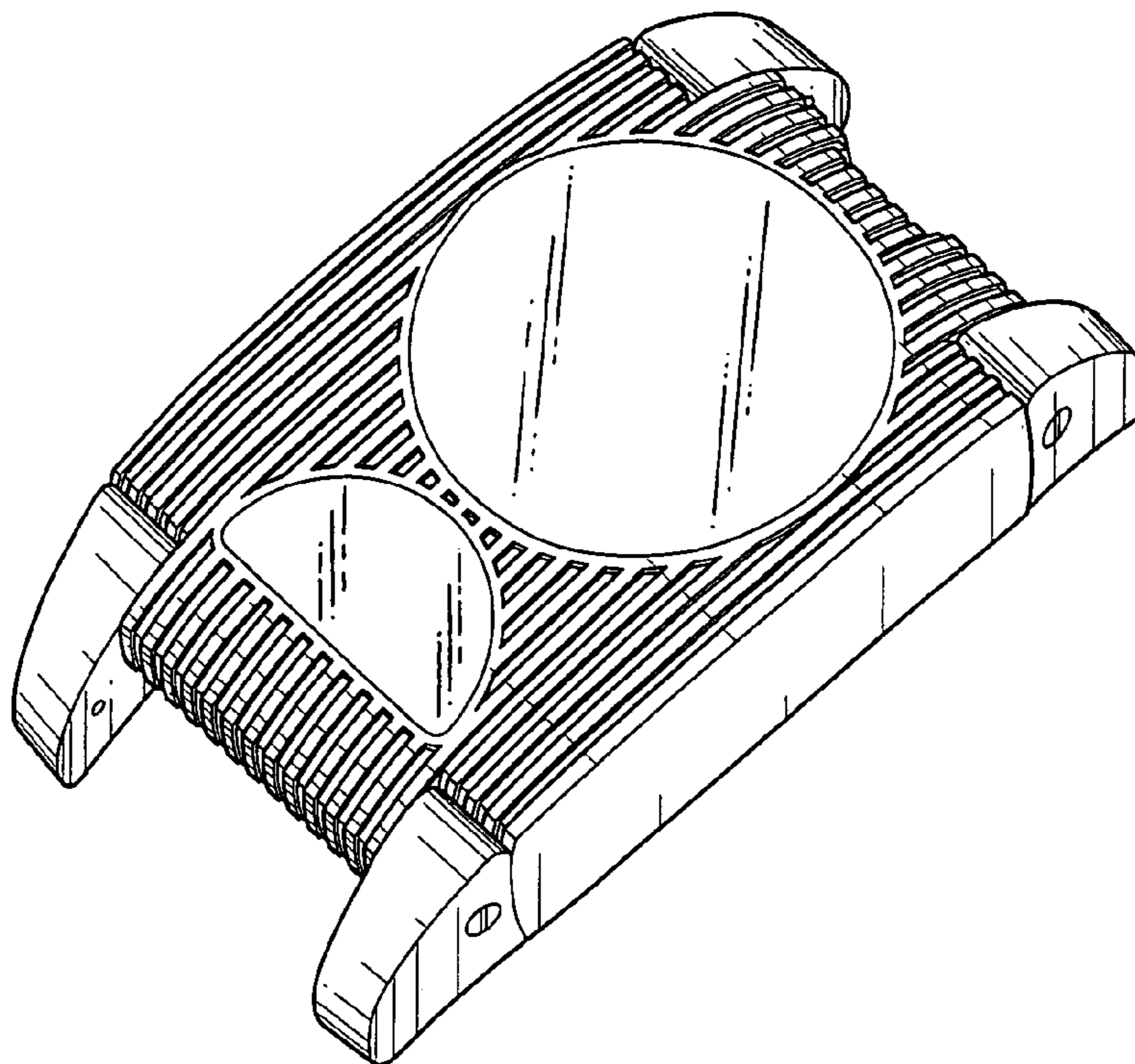

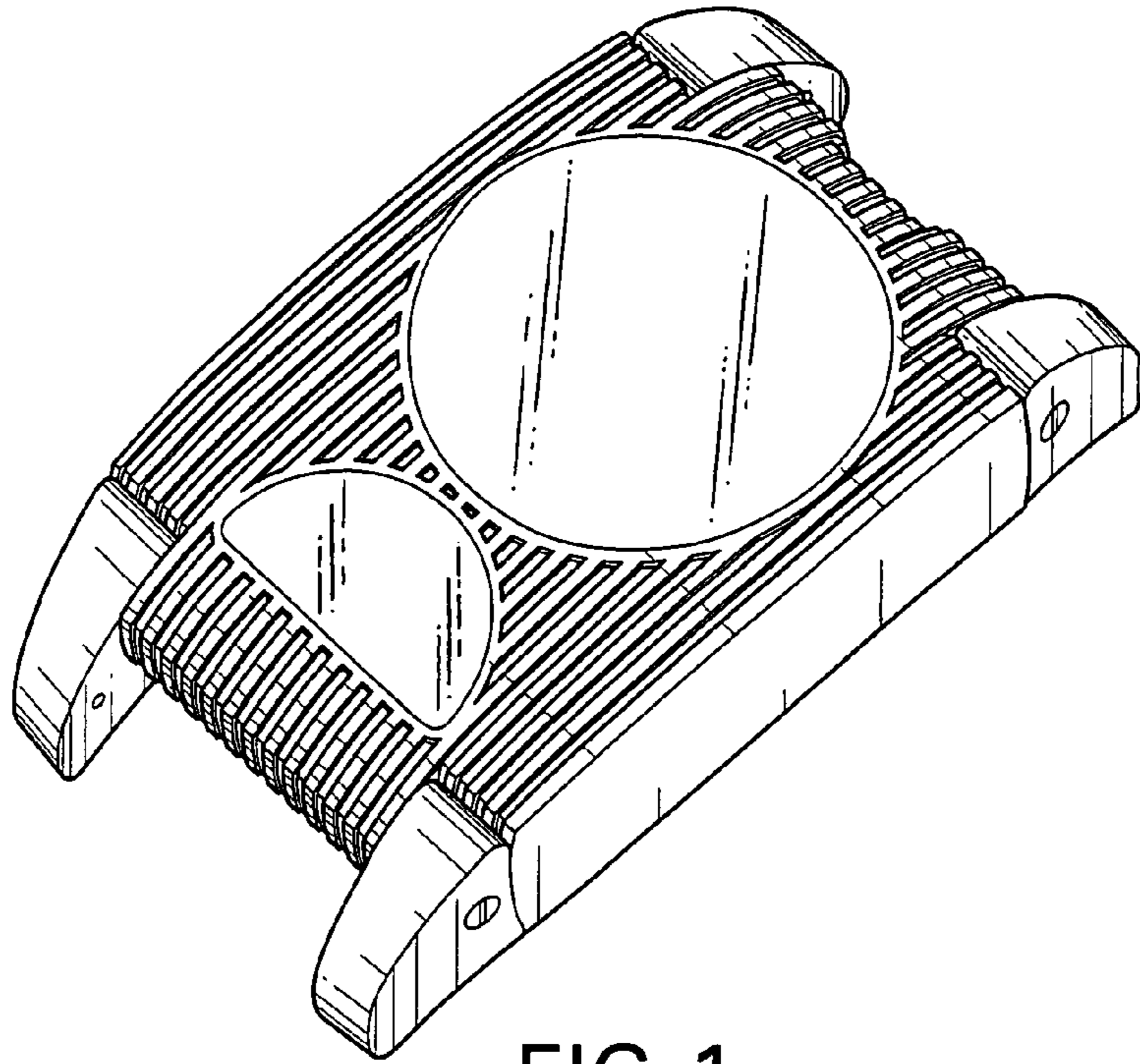

FIG. 1

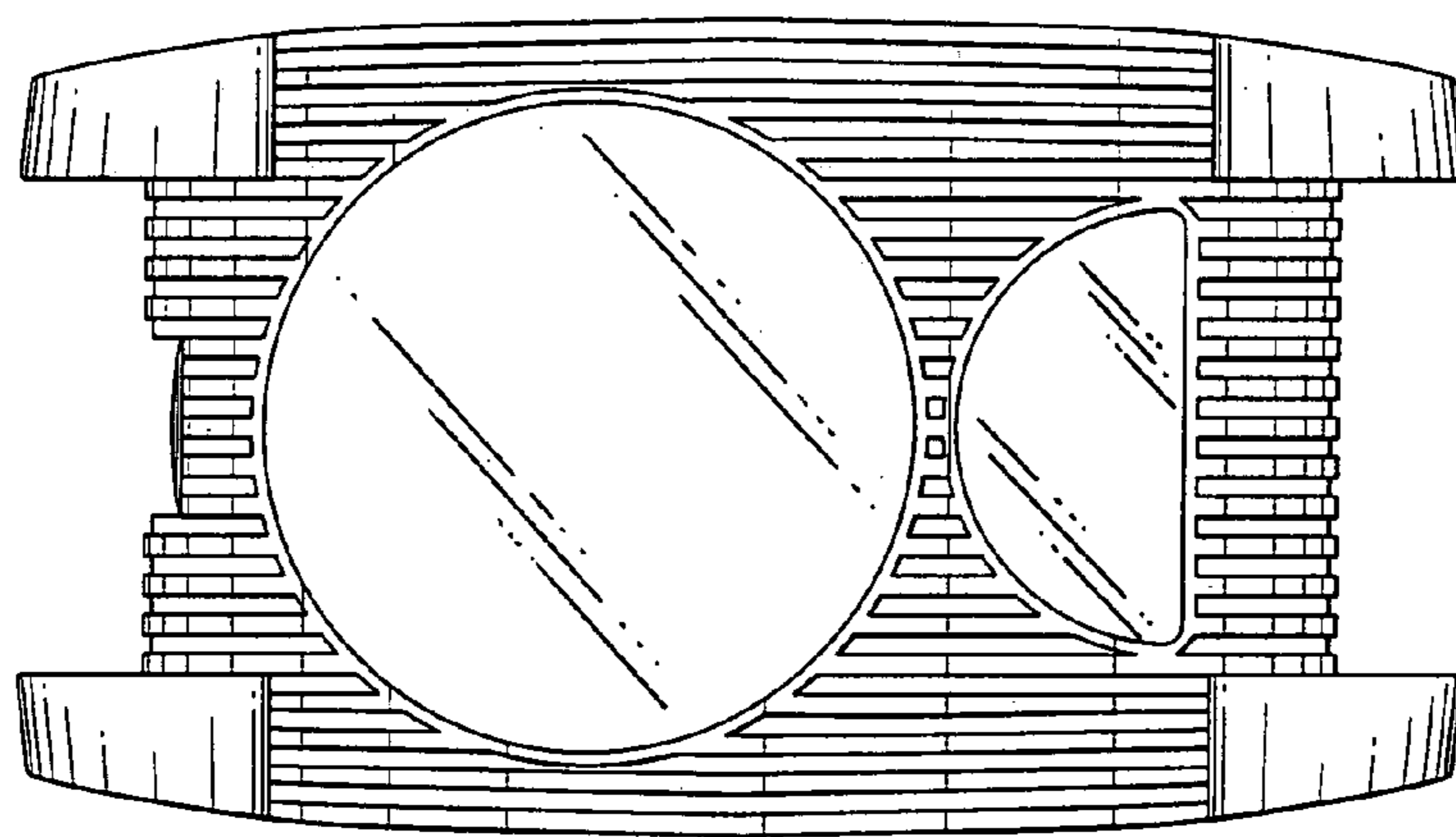

FIG. 2

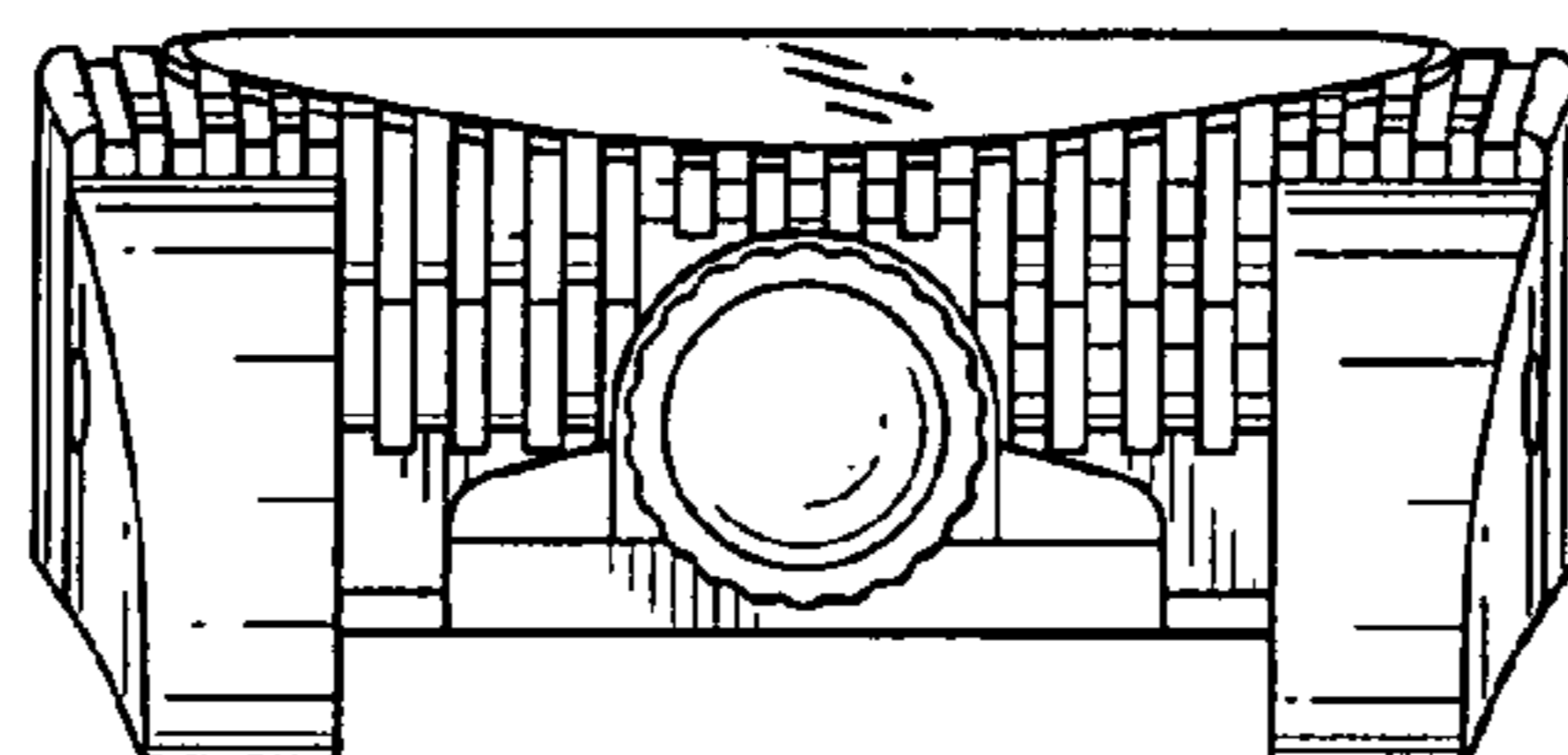

FIG. 3

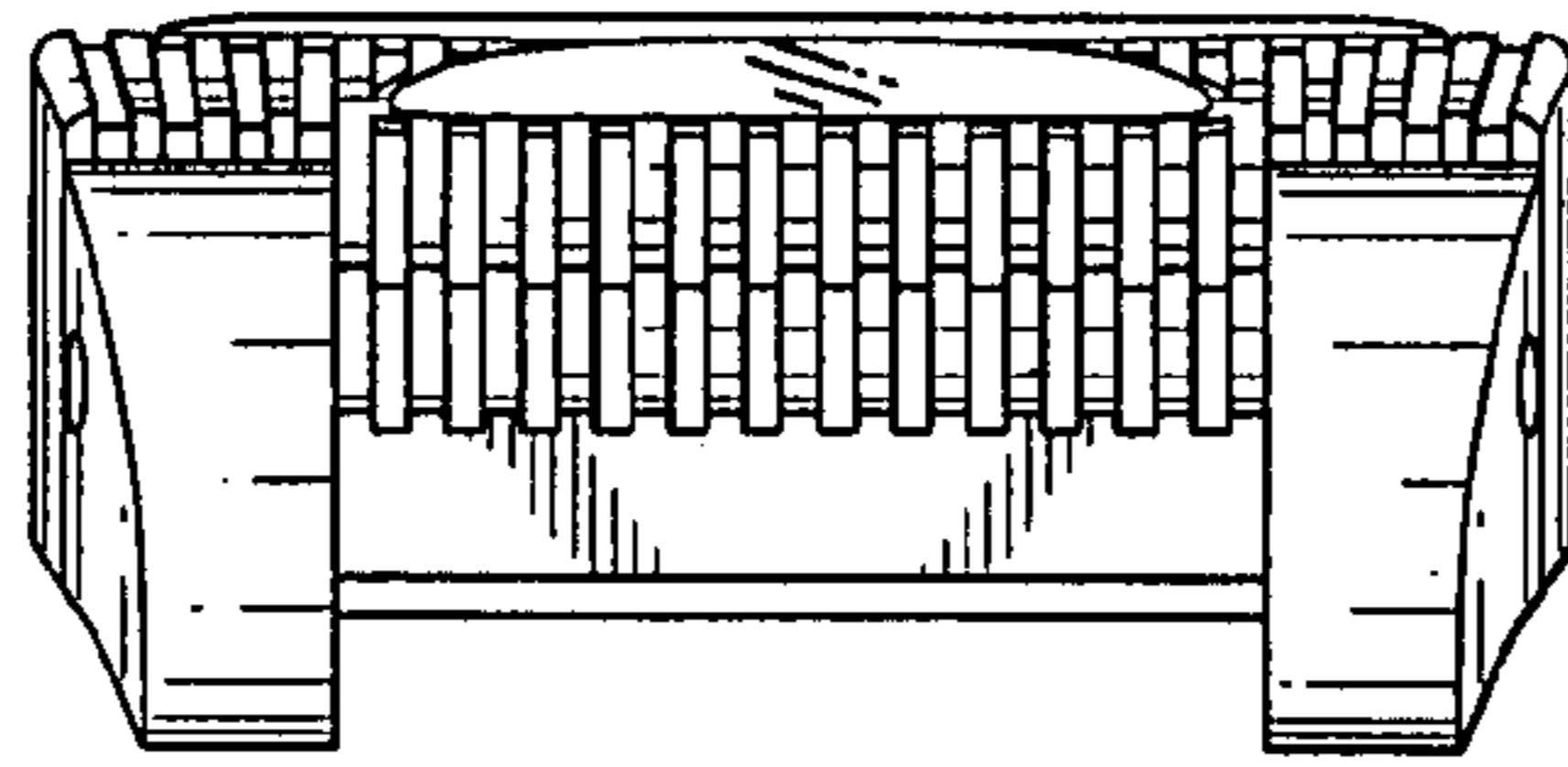

FIG. 4

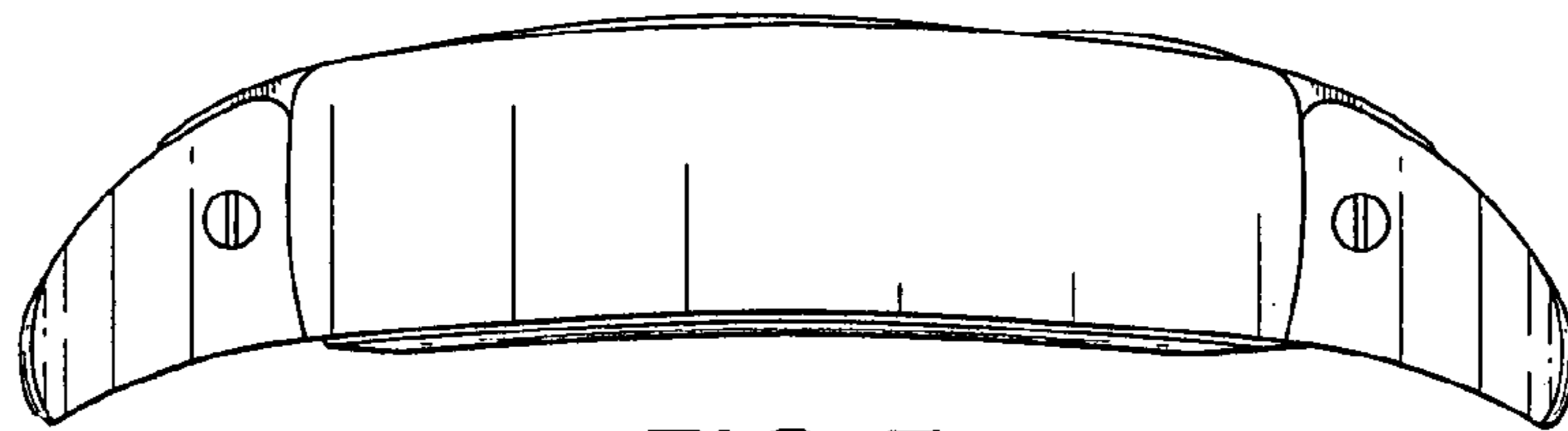

FIG. 5

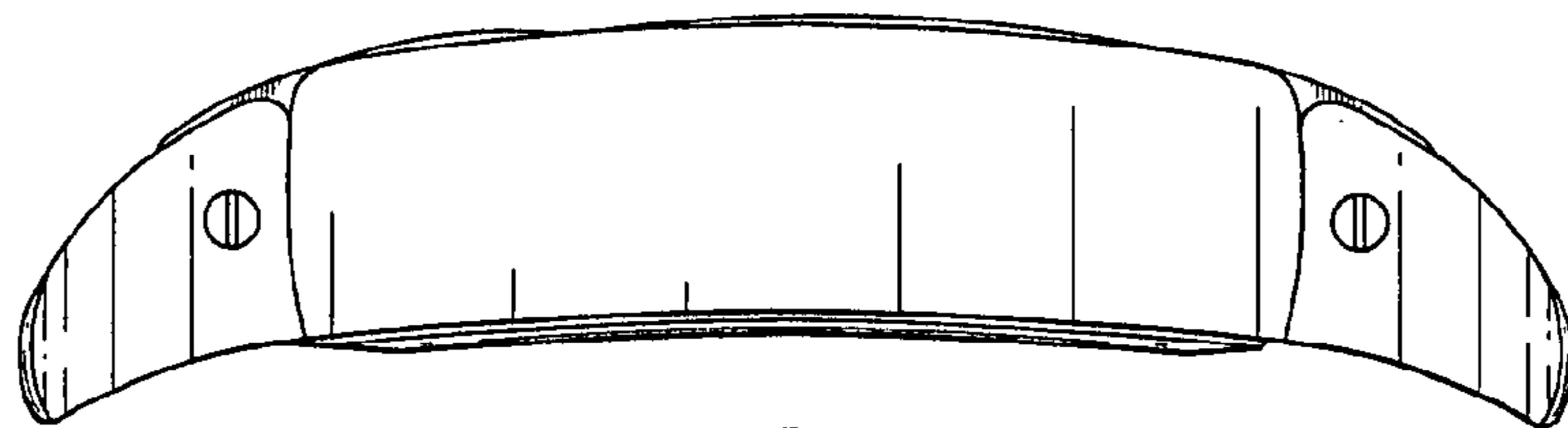

FIG. 6

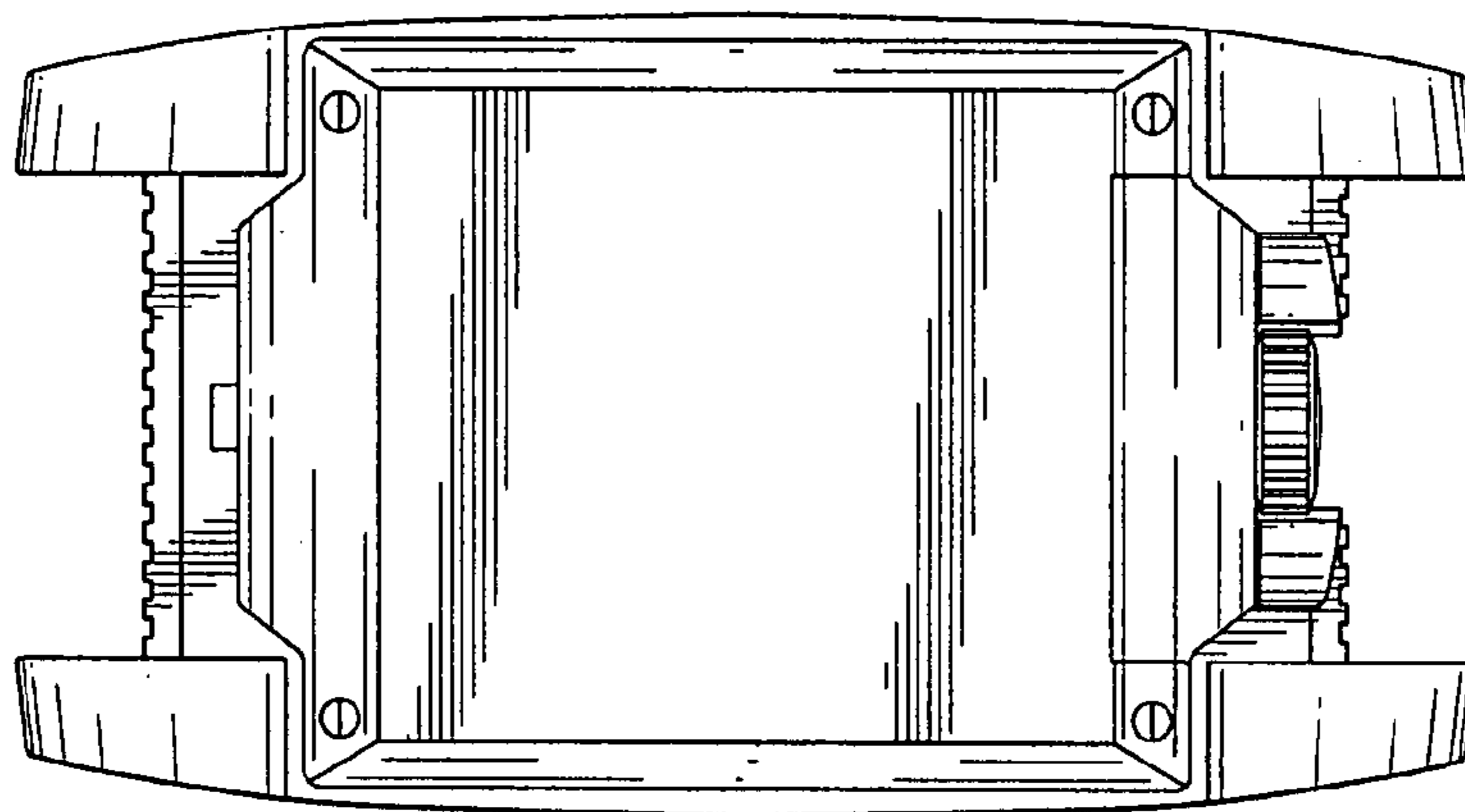

FIG. 7