



US00D549571S

(12) **United States Design Patent**  
**Althouse et al.**

(10) **Patent No.: US D549,571 S**

(45) **Date of Patent: \*\* Aug. 28, 2007**

(54) **PACKAGING**

(75) Inventors: **Rickie Althouse**, Scottsdale, AZ (US);  
**David Hunt**, Cincinnati, OH (US);  
**Vanessa Kamerer**, Scottsdale, AZ  
(US); **Nancy Miller**, Cave Creek, AZ  
(US)

(73) Assignee: **The Dial Corporation**, Scottsdale, AZ  
(US)

(\*\*) Term: **14 Years**

(21) Appl. No.: **29/246,070**

(22) Filed: **Jan. 19, 2006**

(51) **LOC (8) Cl.** ..... **09-03**

(52) **U.S. Cl.** ..... **D9/415; D9/425; D9/418**

(58) **Field of Classification Search** ..... D9/414-433,  
D9/457, 701, 341-348, 730-762, 304, 227;  
206/461-471, 495, 806

See application file for complete search history.

(56) **References Cited**

U.S. PATENT DOCUMENTS

4,570,818	A *	2/1986	Borst et al.	220/835
D315,302	S *	3/1991	Kistler	D9/415
D378,894	S *	4/1997	Mello	D9/759
D456,249	S *	4/2002	Pearson et al.	D9/415
D499,963	S *	12/2004	Church	D9/415
D534,795	S *	1/2007	Manuel et al.	D9/425
2005/0092644	A1 *	5/2005	Cafferata et al.	206/471

\* cited by examiner

*Primary Examiner*—Louis S. Zarfaz

*Assistant Examiner*—Susan E Krakower

(74) *Attorney, Agent, or Firm*—Snell & Wilmer LLP

(57) **CLAIM**

The ornamental design for a packaging, as shown and described.

**DESCRIPTION**

FIG. 1 is a perspective view of packaging showing an embodiment of our new design;

FIG. 2 is a front elevational view of the packaging of FIG. 1;

FIG. 3 is a back elevational view of the packaging of FIG. 1;

FIG. 4 is a right side elevational view of the packaging of FIG. 1;

FIG. 5 is a left side elevational view of the packaging of FIG. 1;

FIG. 6 is a top plan view of the packaging of FIG. 1;

FIG. 7 is a bottom plan view of the packaging of FIG. 1;

FIG. 8 is a perspective view of packaging showing an alternative embodiment of our new design;

FIG. 9 is a front elevational view of the packaging of FIG. 8;

FIG. 10 is a back elevational view of the packaging of FIG. 8;

FIG. 11 is a right side elevational view of the packaging of FIG. 8;

FIG. 12 is a left side elevational view of the packaging of FIG. 8;

FIG. 13 is a top plan view of the packaging of FIG. 8; and,

FIG. 14 is a bottom plan view of the packaging of FIG. 8.

The broken line showing of a top opening and rear protrusions are included for the purpose of illustrating environmental structure and forms no part of the claimed design.

**1 Claim, 10 Drawing Sheets**

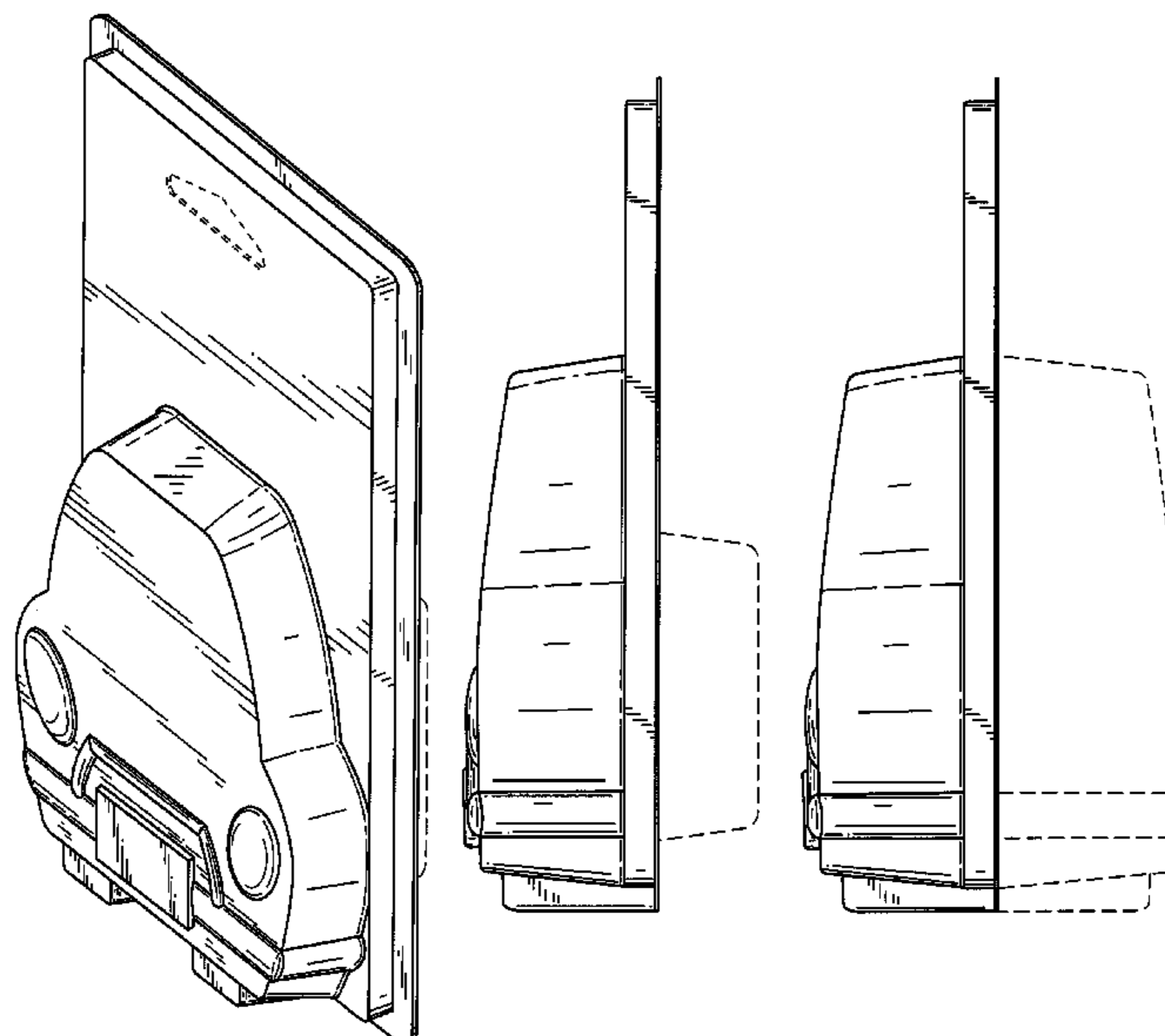

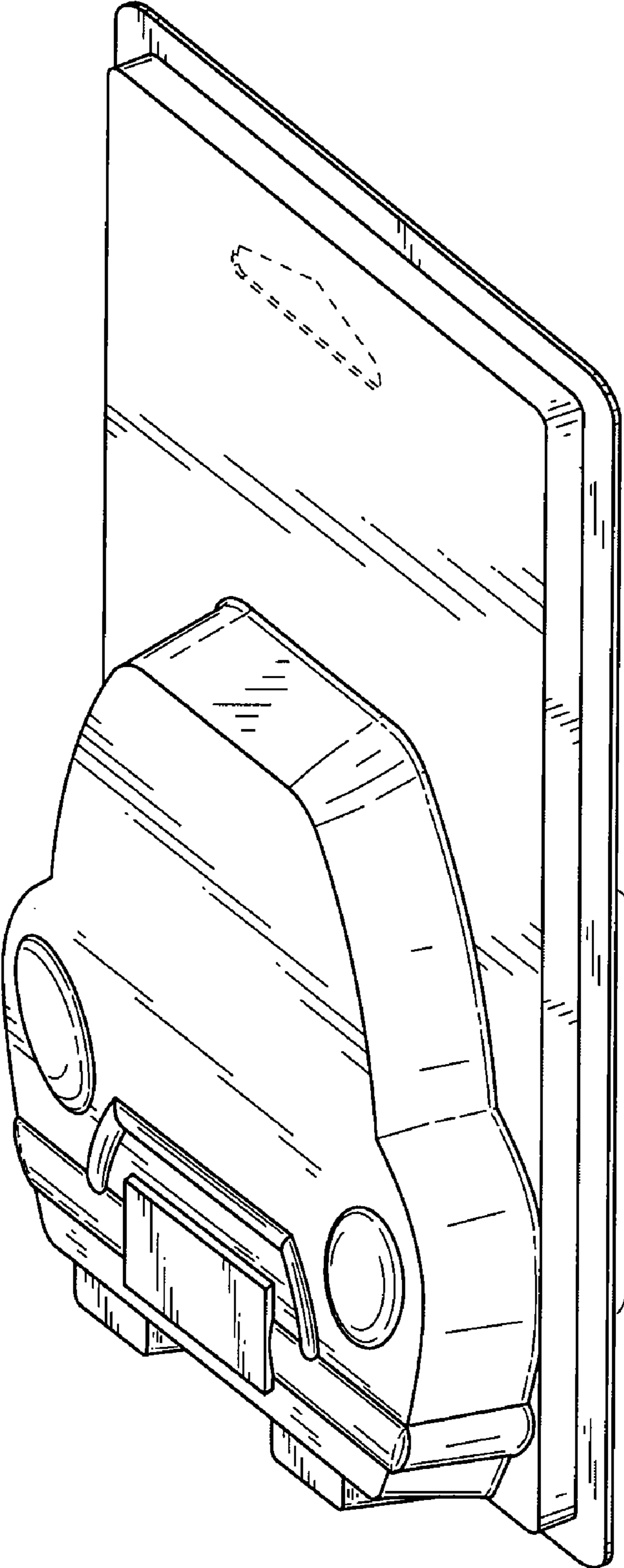

FIG.1

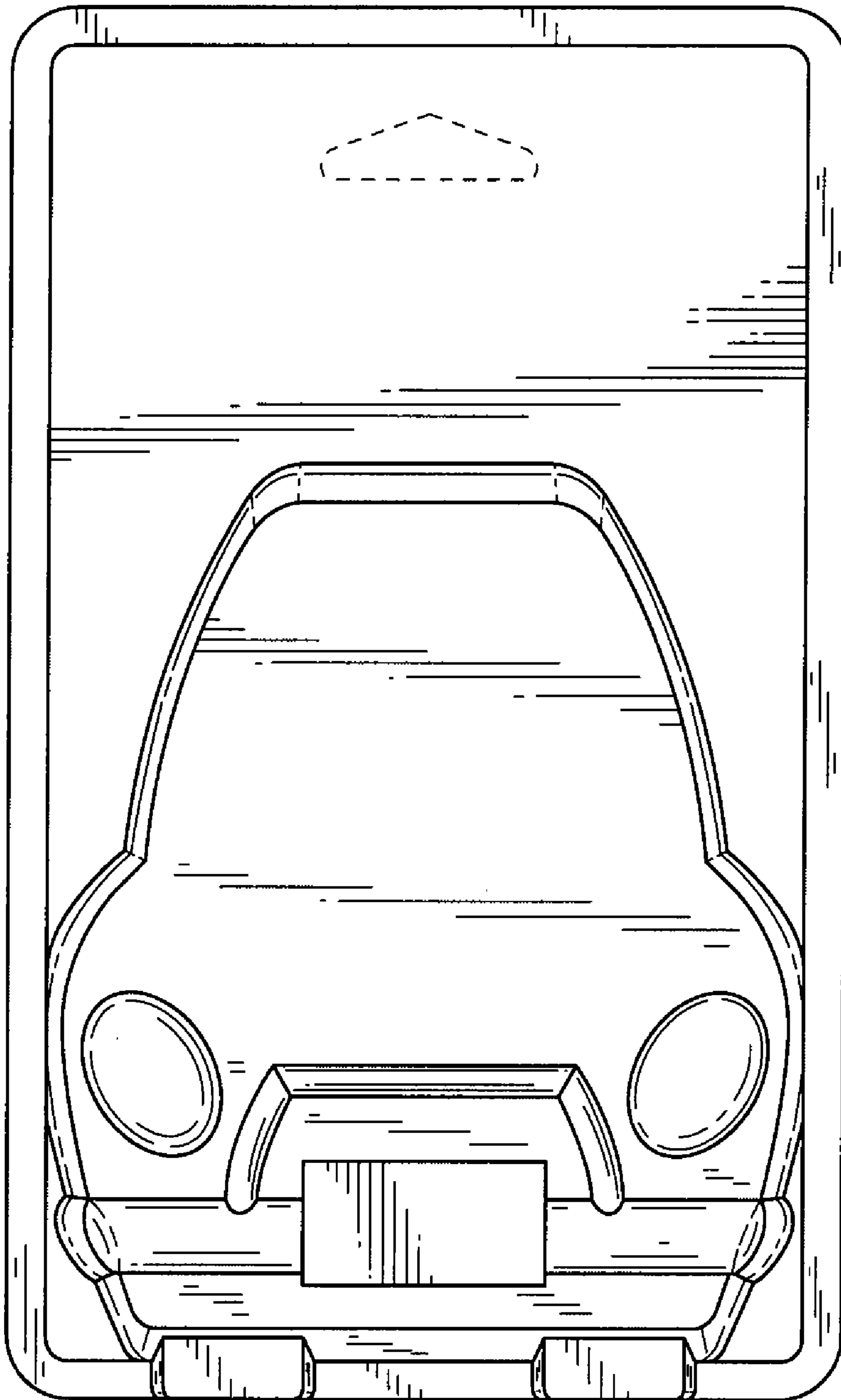

FIG.2

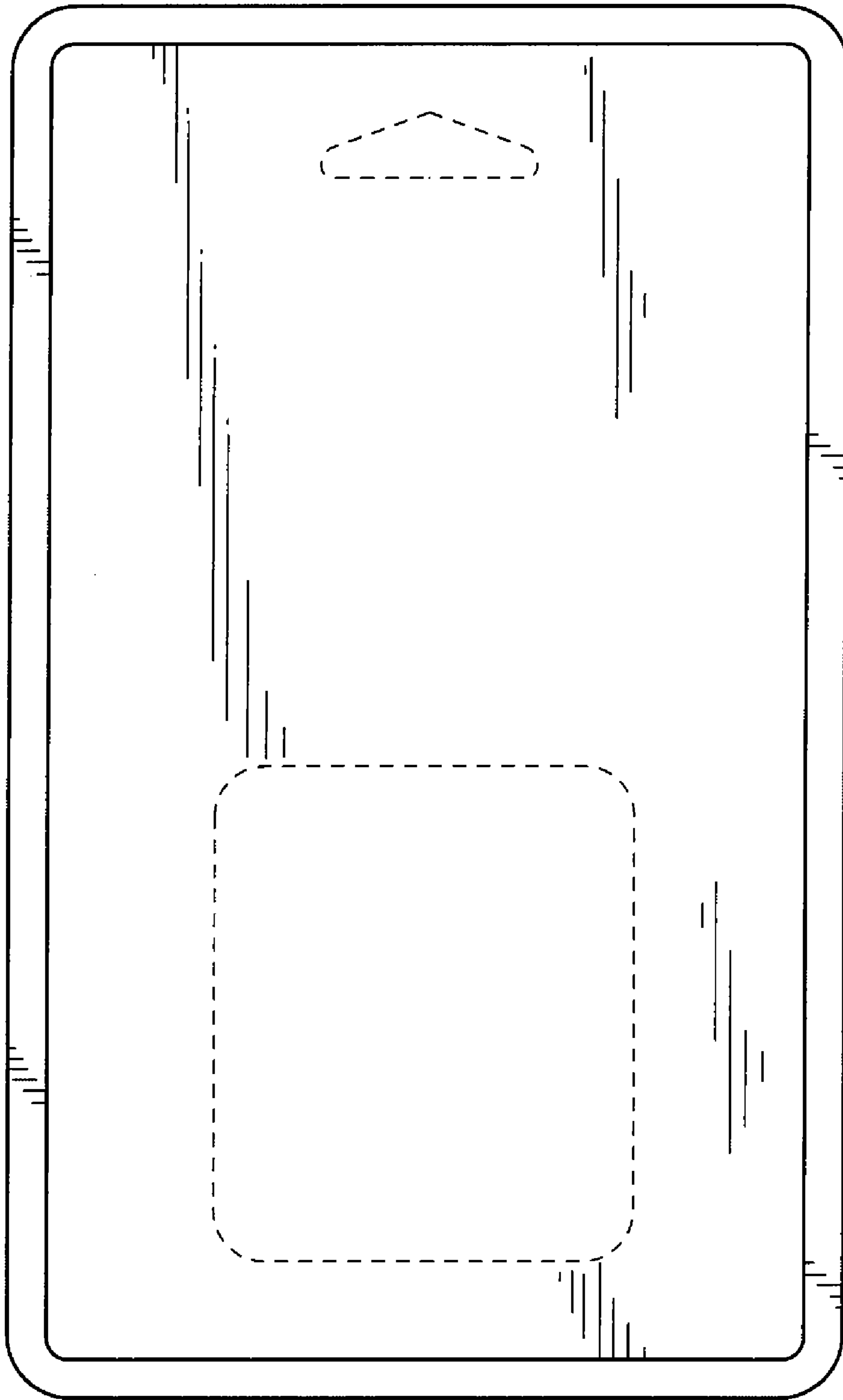

FIG.3

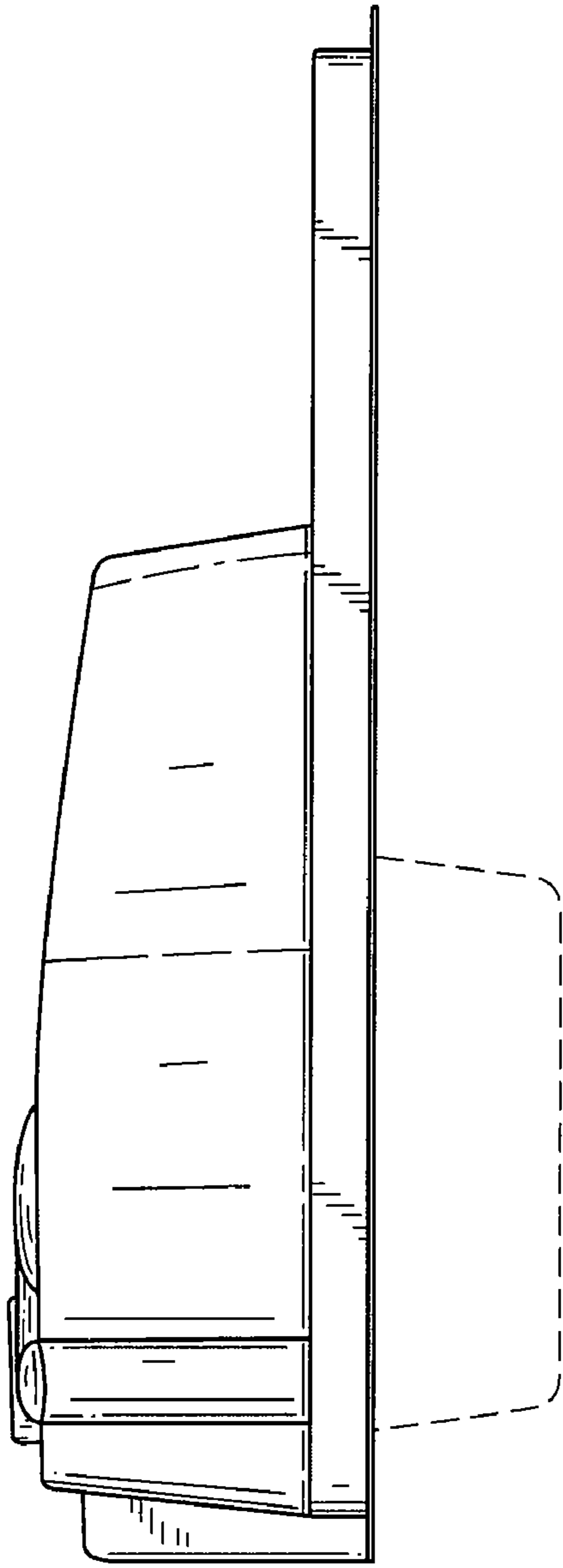

FIG.4

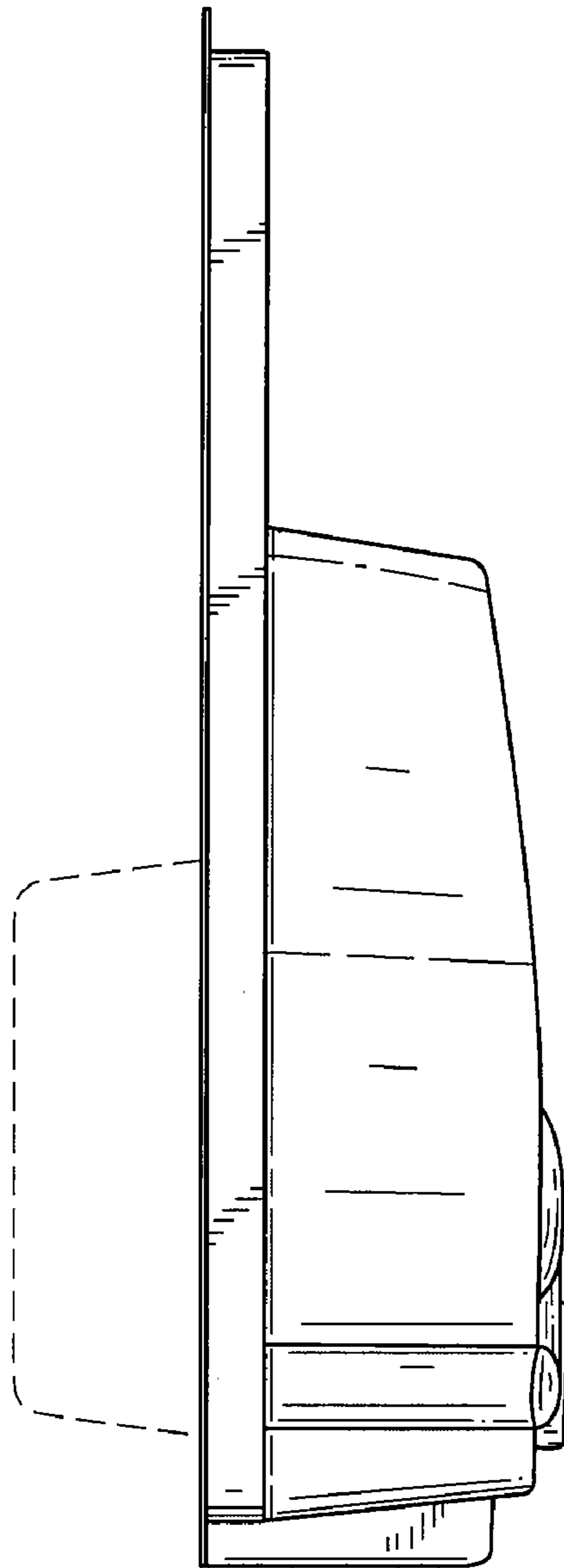

FIG.5

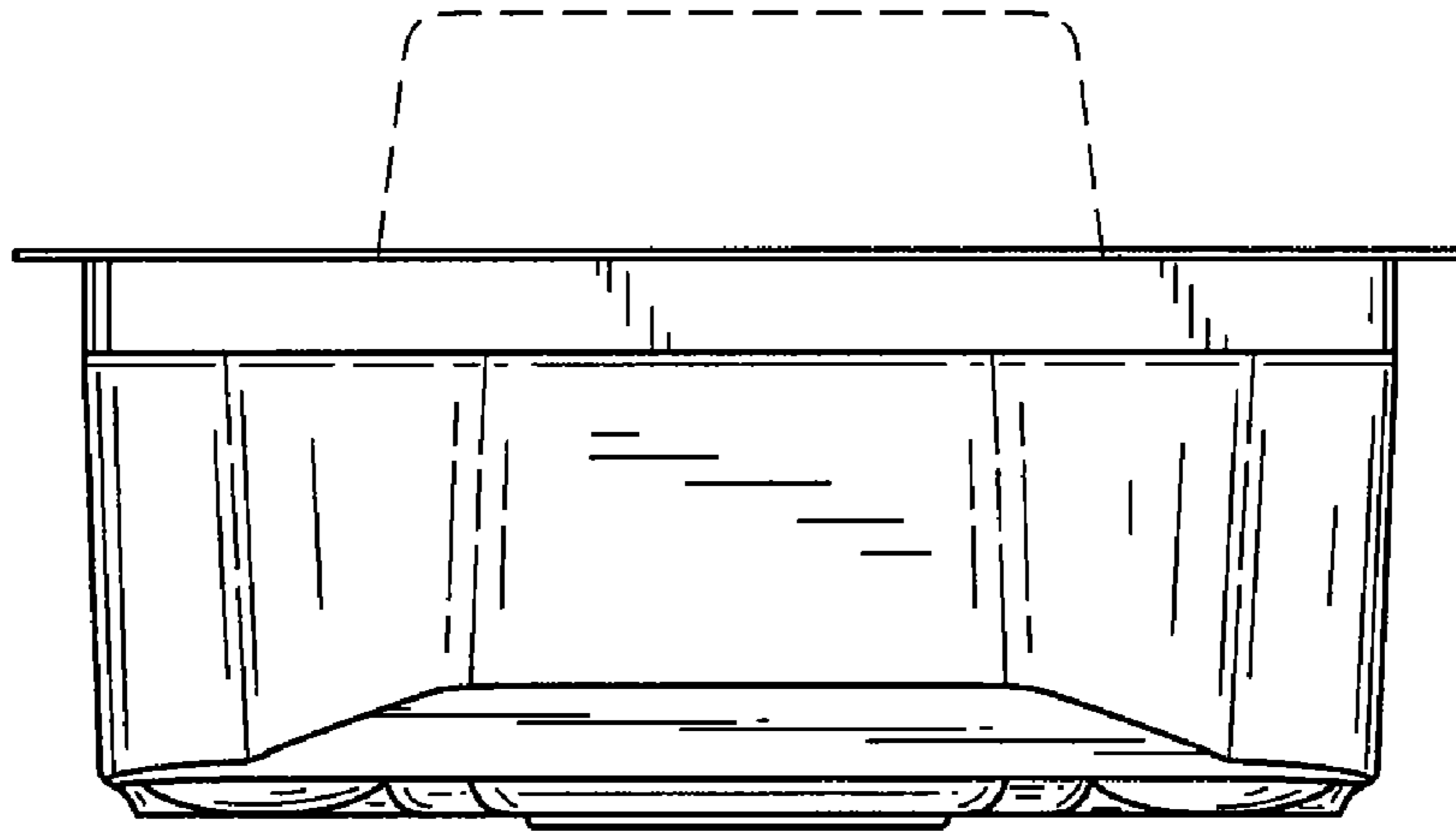

FIG. 6

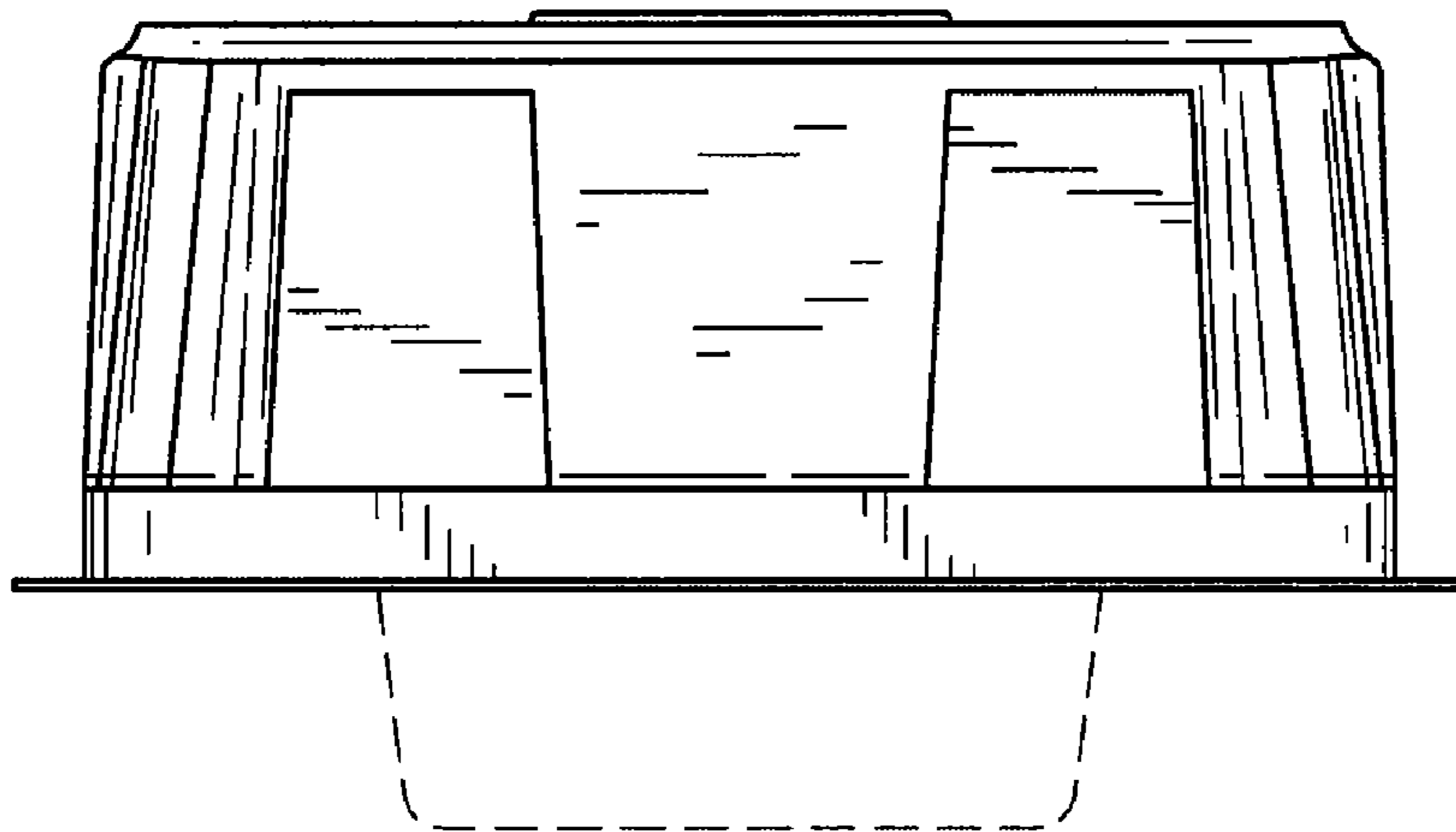

FIG. 7

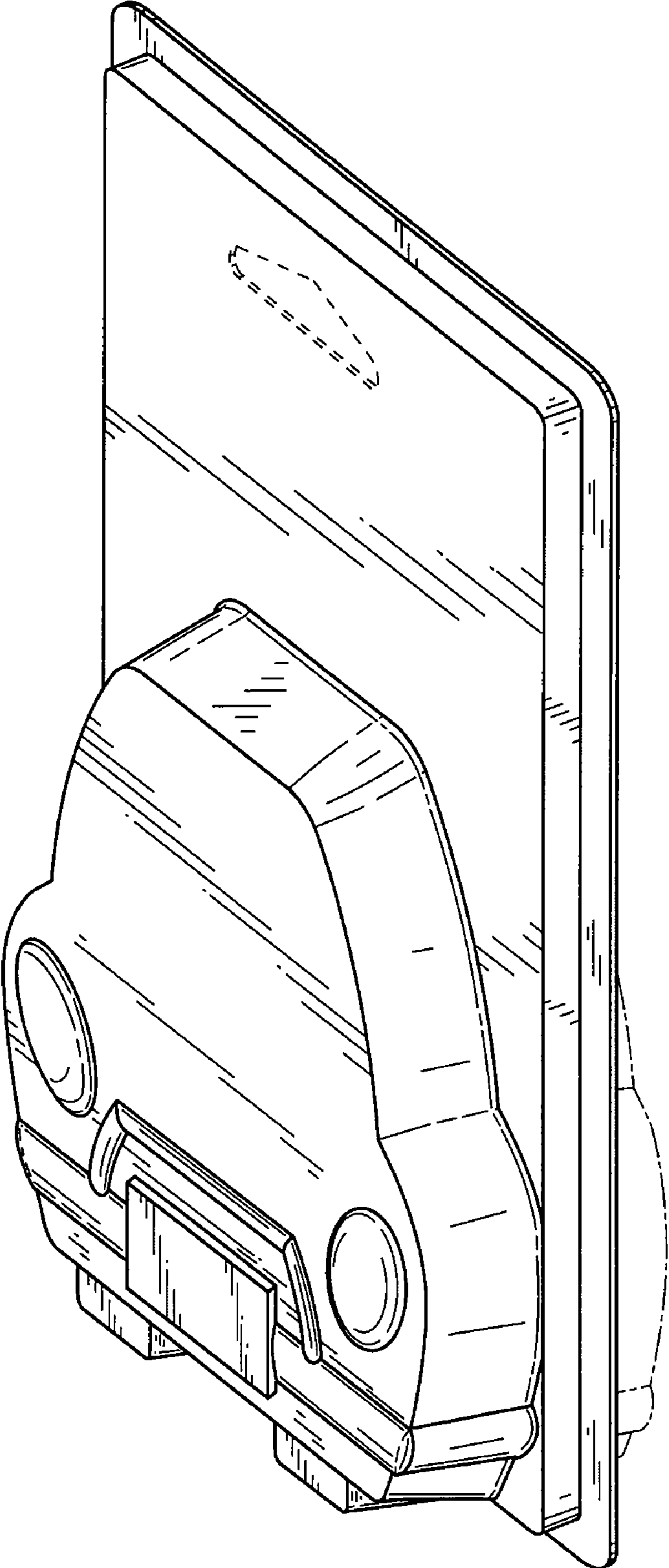

FIG.8

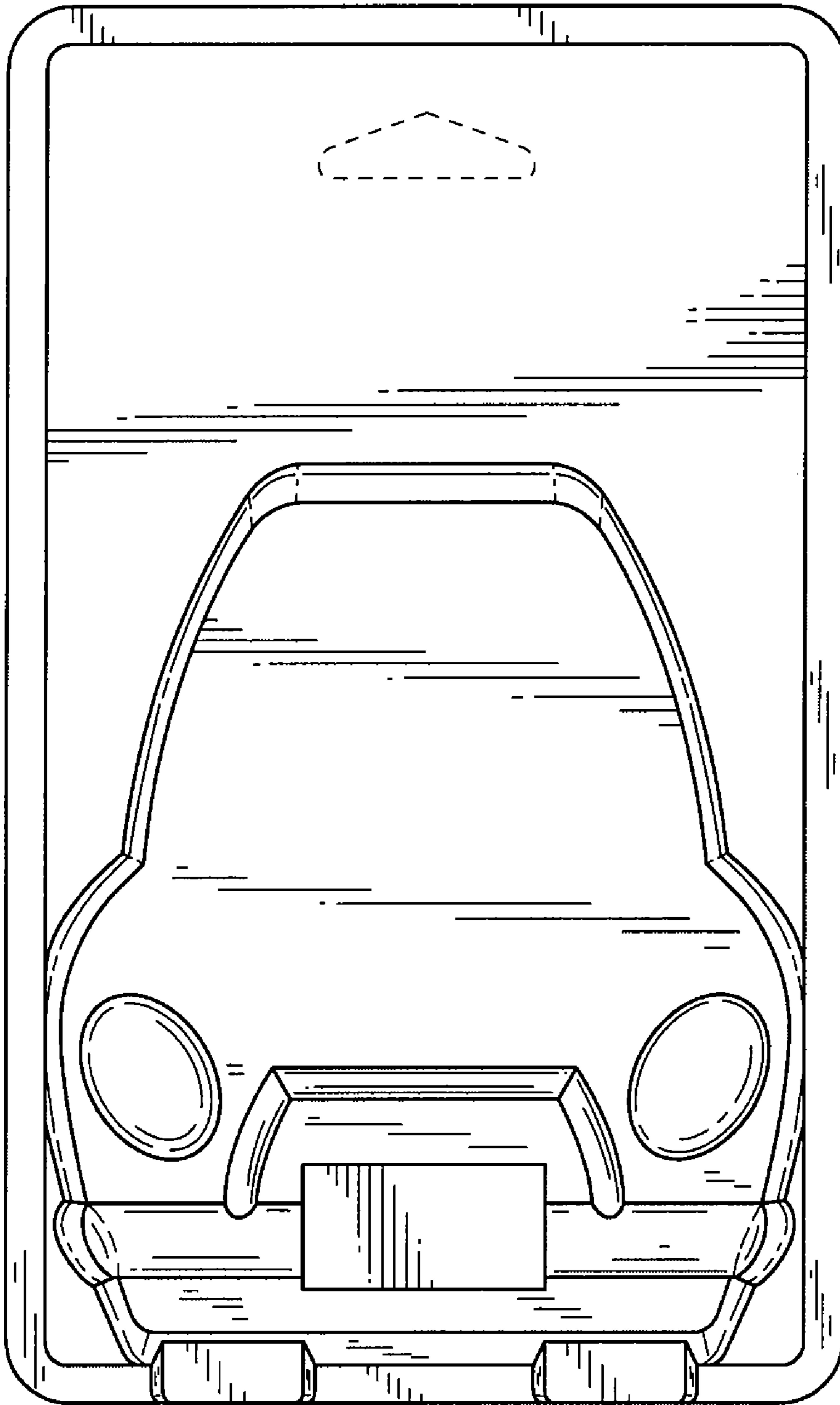

FIG.9



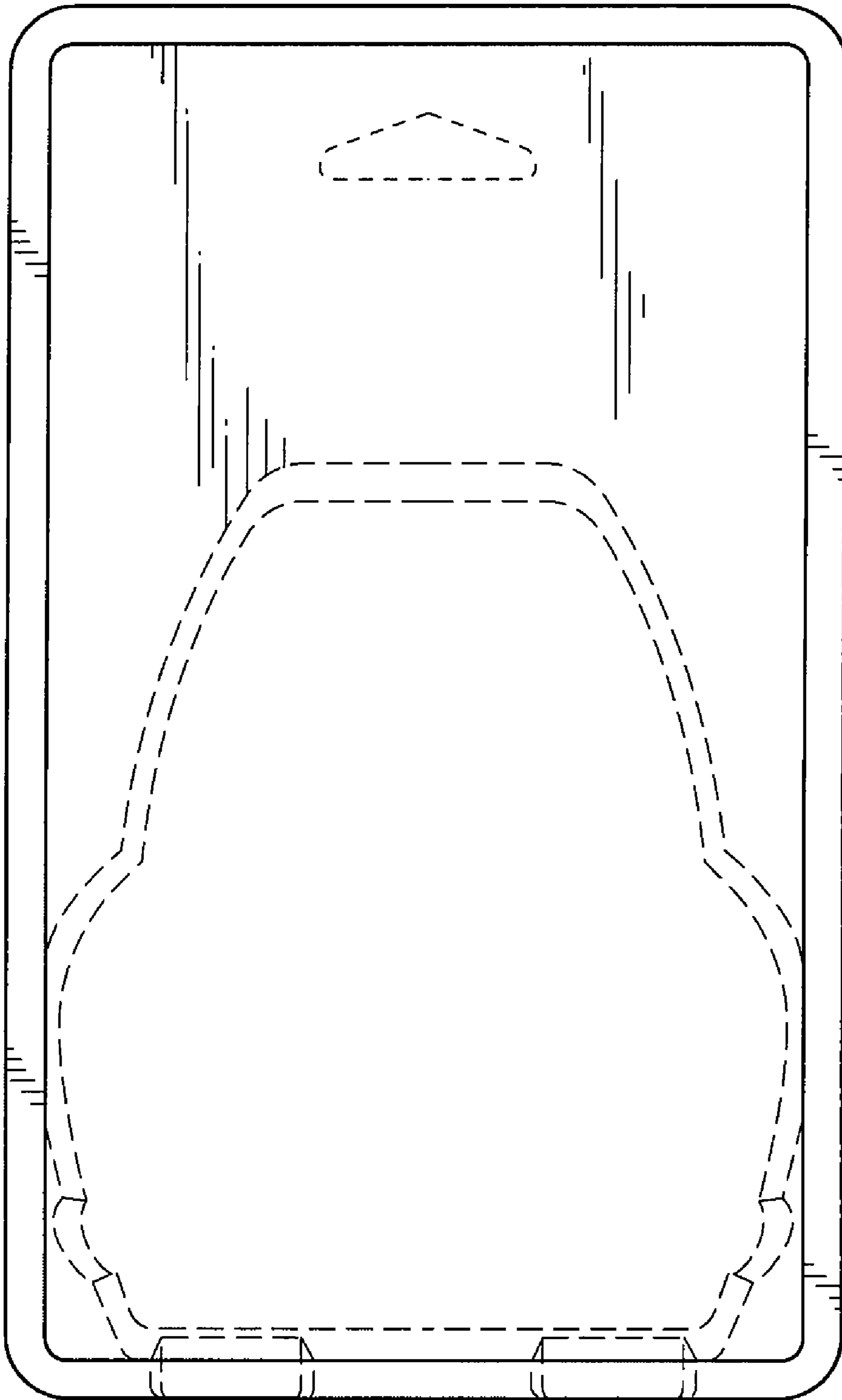

FIG. 10

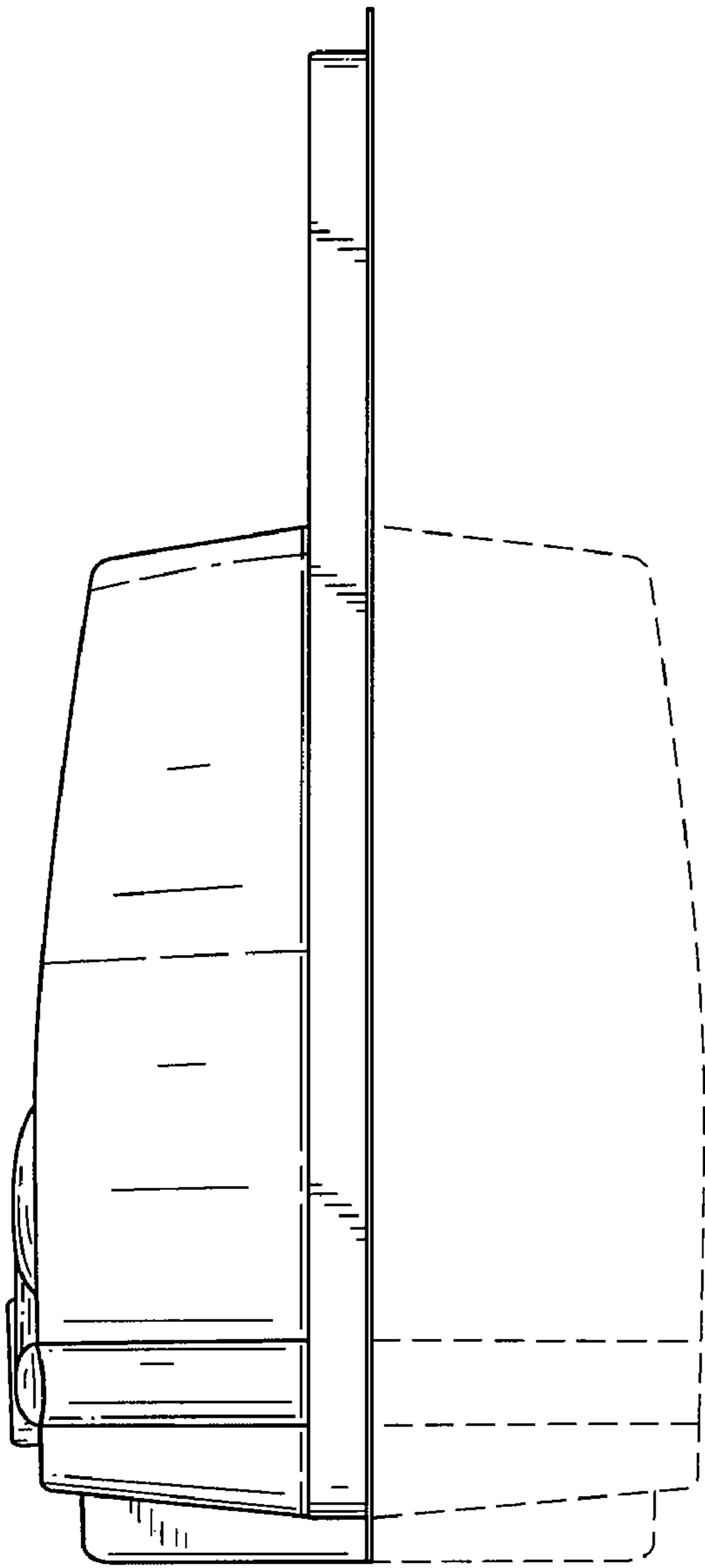

FIG.11

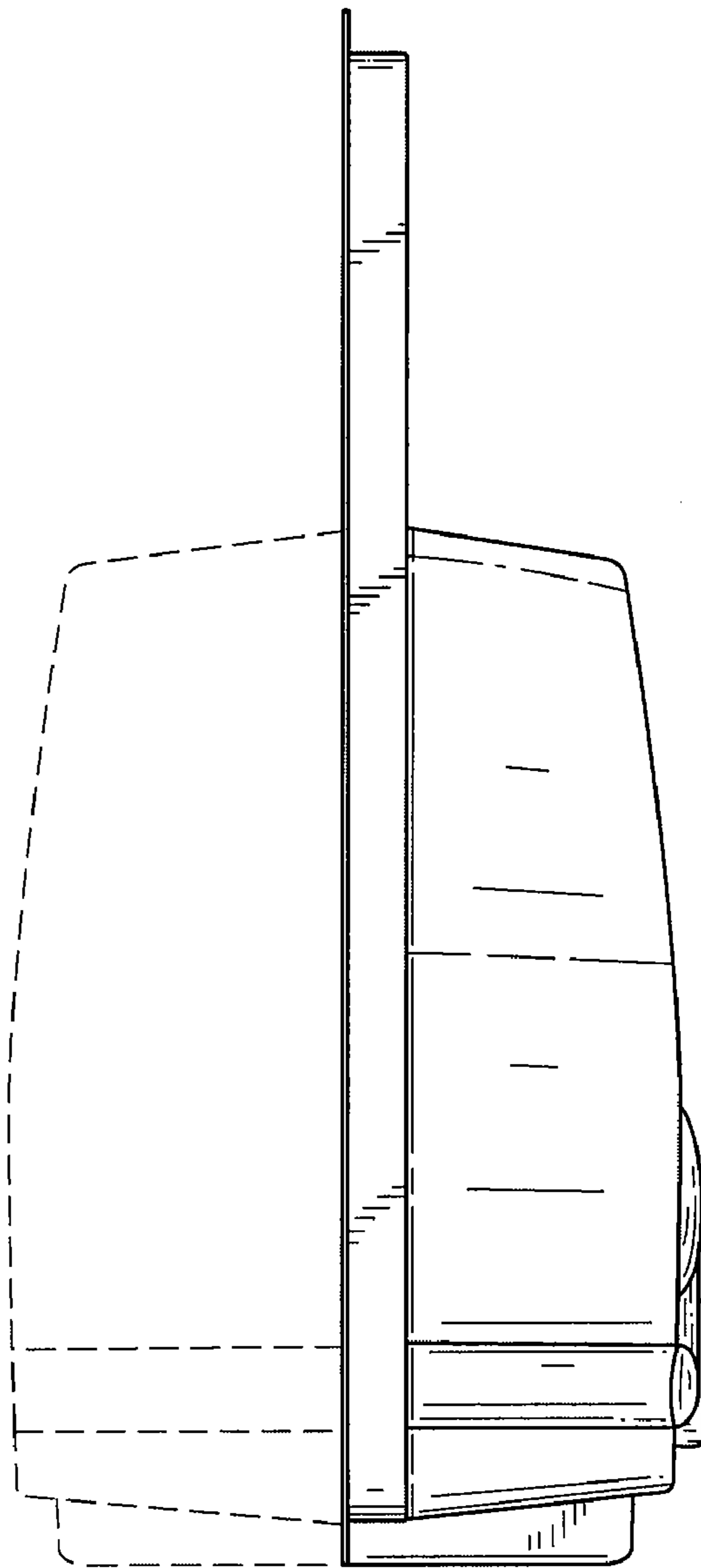

FIG.12

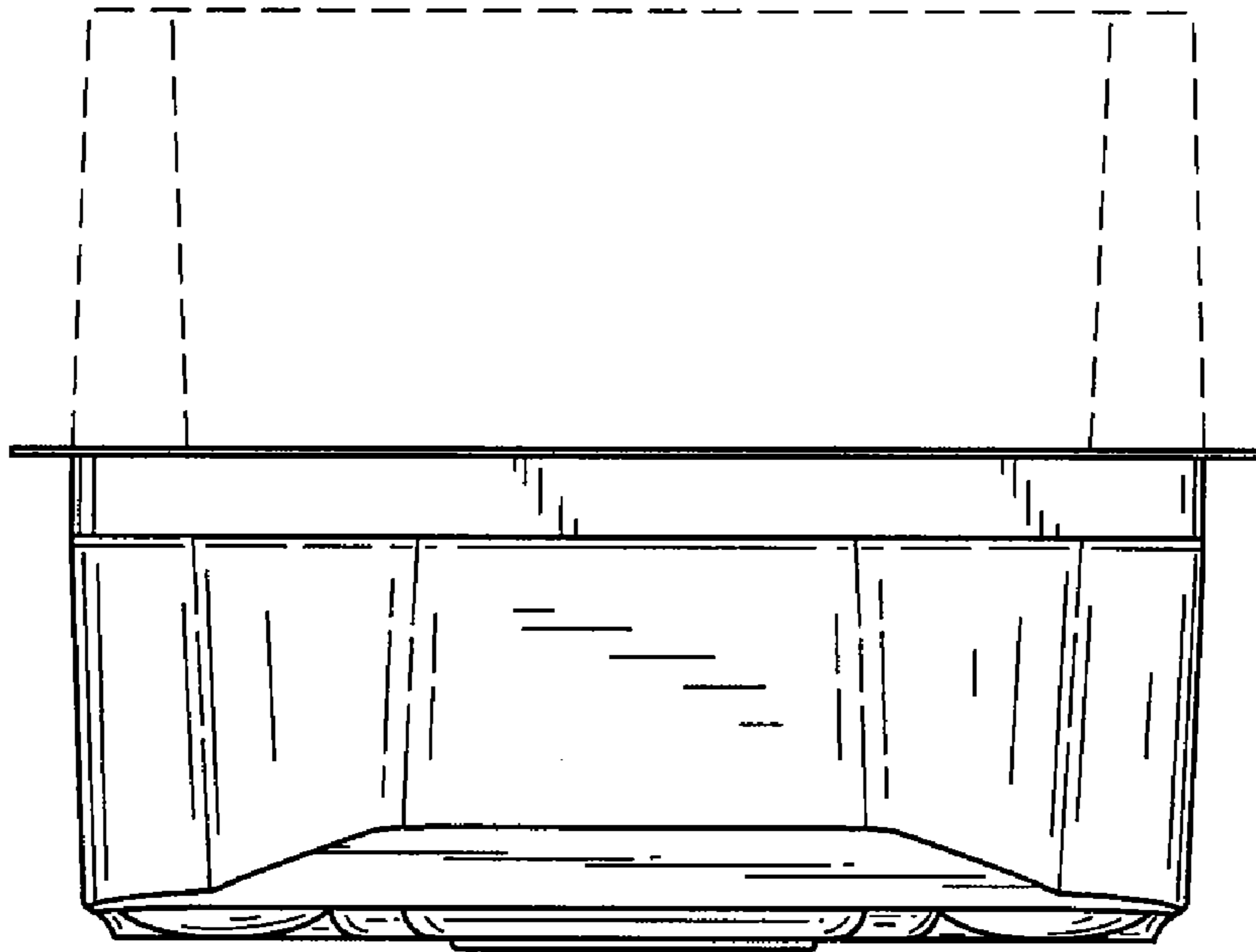

FIG.13

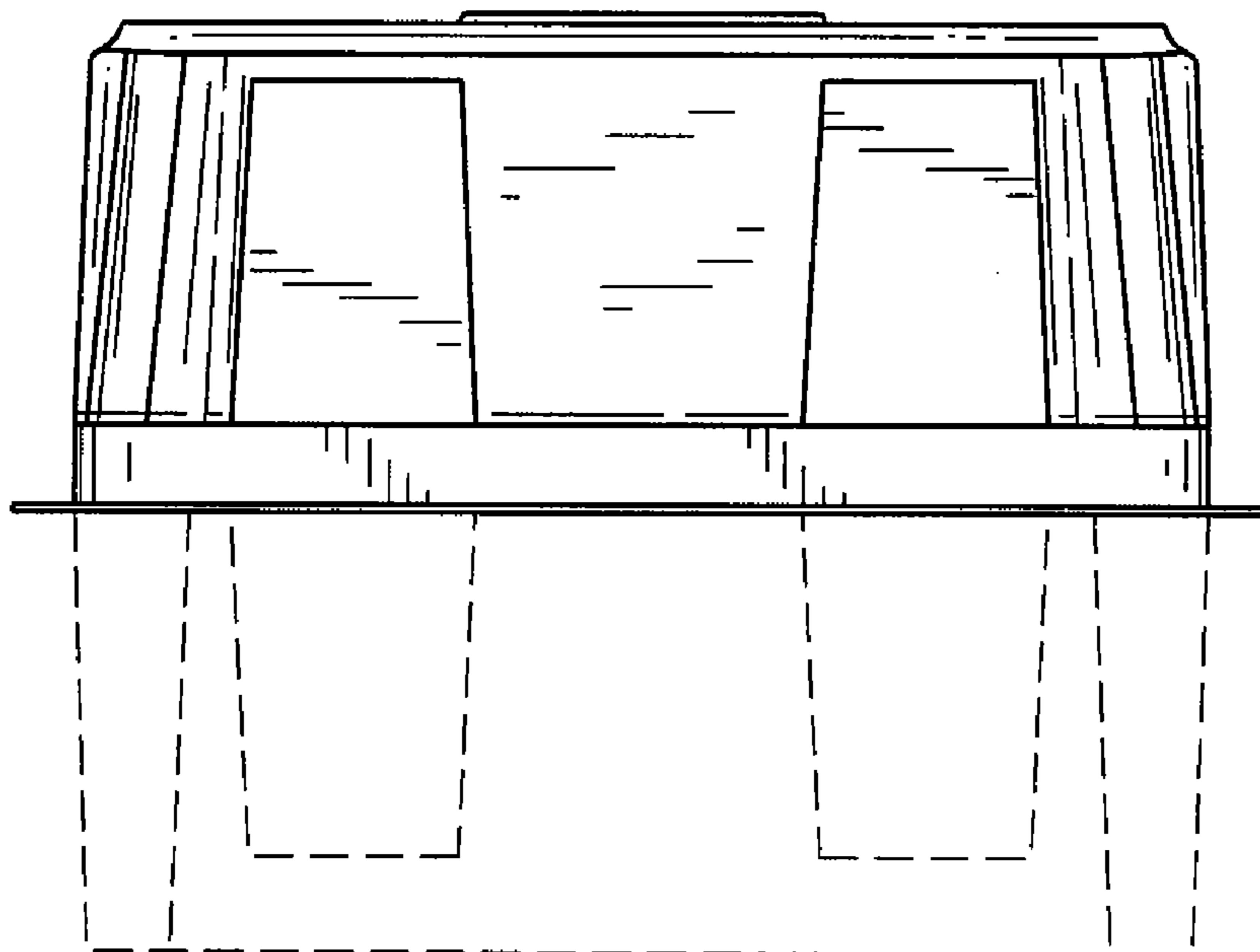

FIG.14