

US00D549523S

(12) **United States Design Patent**
Montes

(10) **Patent No.:** **US D549,523 S**

(45) **Date of Patent:** **** Aug. 28, 2007**

(54) **CUP**
(75) Inventor: **Andrea Montes**, Los Angeles, CA (US)
(73) Assignee: **Misaine Trade, Inc.**, Gardena, CA (US)
(**) Term: **14 Years**

(21) Appl. No.: **29/264,940**
(22) Filed: **Aug. 21, 2006**

(51) **LOC (8) Cl.** **07-01**
(52) **U.S. Cl.** **D7/536; D7/533; D7/509**
(58) **Field of Classification Search** D7/319,
D7/361, 396.2, 500, 509, 510, 513-515, 518,
D7/521, 531-536, 538, 541, 545, 601, 613,
D7/622; D3/271.6; D8/DIG. 9; D9/516,
D9/555, 600, 636, 716, 718, 741, 751; D24/122;
D25/7, 102, 104, 117, 130; D26/11; D34/7,
D34/9; 206/520; 215/DIG. 7, 387; 220/DIG. 13,
220/4.06, 4.24, 507, 516, 592.16, 592.17,
220/669, 710.5; 229/400, 402
See application file for complete search history.

(56) **References Cited**

U.S. PATENT DOCUMENTS

2,002 A * 3/1841 Peters 111/81
D194,053 S * 11/1962 Cornelius D7/536
D202,643 S * 10/1965 Hoyt, Jr. D7/536

D224,804 S * 9/1972 Dennerlein et al. D7/622
D293,293 S * 12/1987 Isles D7/396.6
D465,132 S * 11/2002 Janky et al. D7/510
D511,072 S * 11/2005 Trombly D7/533
D517,370 S * 3/2006 Kingsley D7/532
D524,602 S * 7/2006 Arduini D7/536

* cited by examiner

Primary Examiner—Philip S. Hyder

Assistant Examiner—Cynthia Underwood

(74) *Attorney, Agent, or Firm*—Knobbe Martens Olson & Bear LLP

(57) **CLAIM**

The ornamental design for a cup, as shown and described herein.

DESCRIPTION

FIG. 1 is a perspective view of an embodiment of a cup.
FIG. 2 is a front view of an embodiment of a cup.
FIG. 3 is a back view of an embodiment of a cup.
FIG. 4 is a first side view of an embodiment of a cup.
FIG. 5 is a second side view of an embodiment of a cup.
FIG. 6 is a top view of an embodiment of a cup; and,
FIG. 7 is a bottom view of an embodiment of a cup.

1 Claim, 6 Drawing Sheets

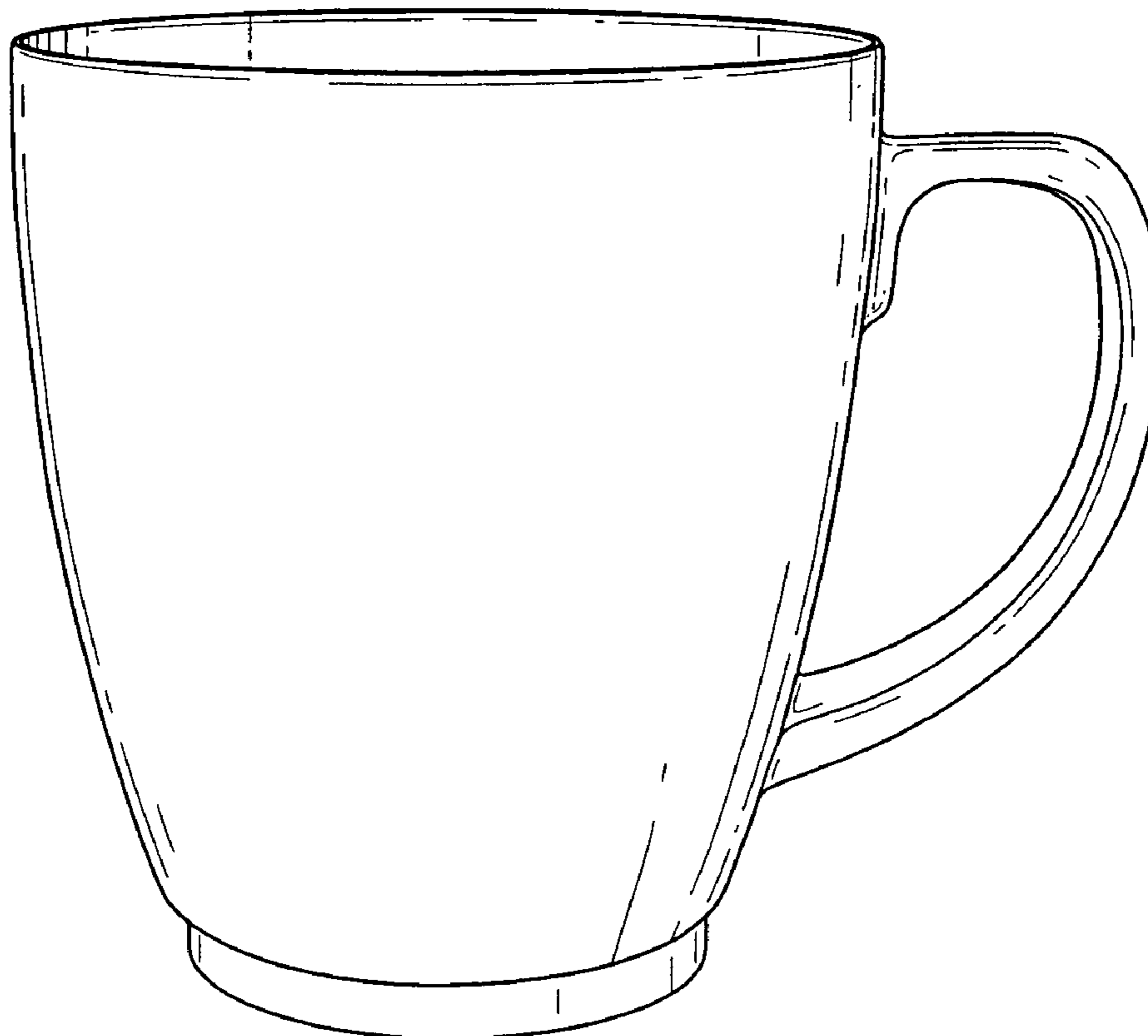

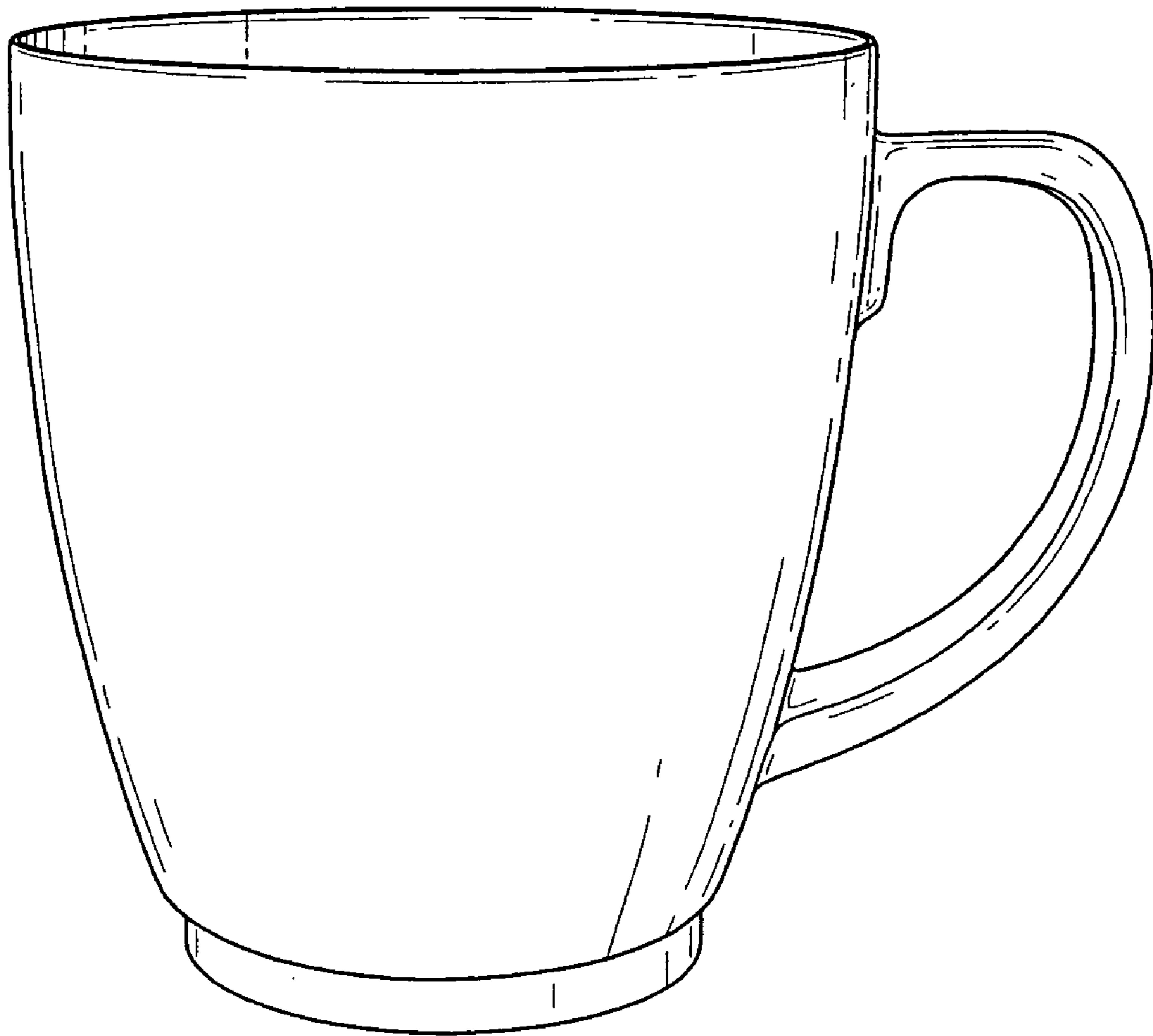

FIG. 1

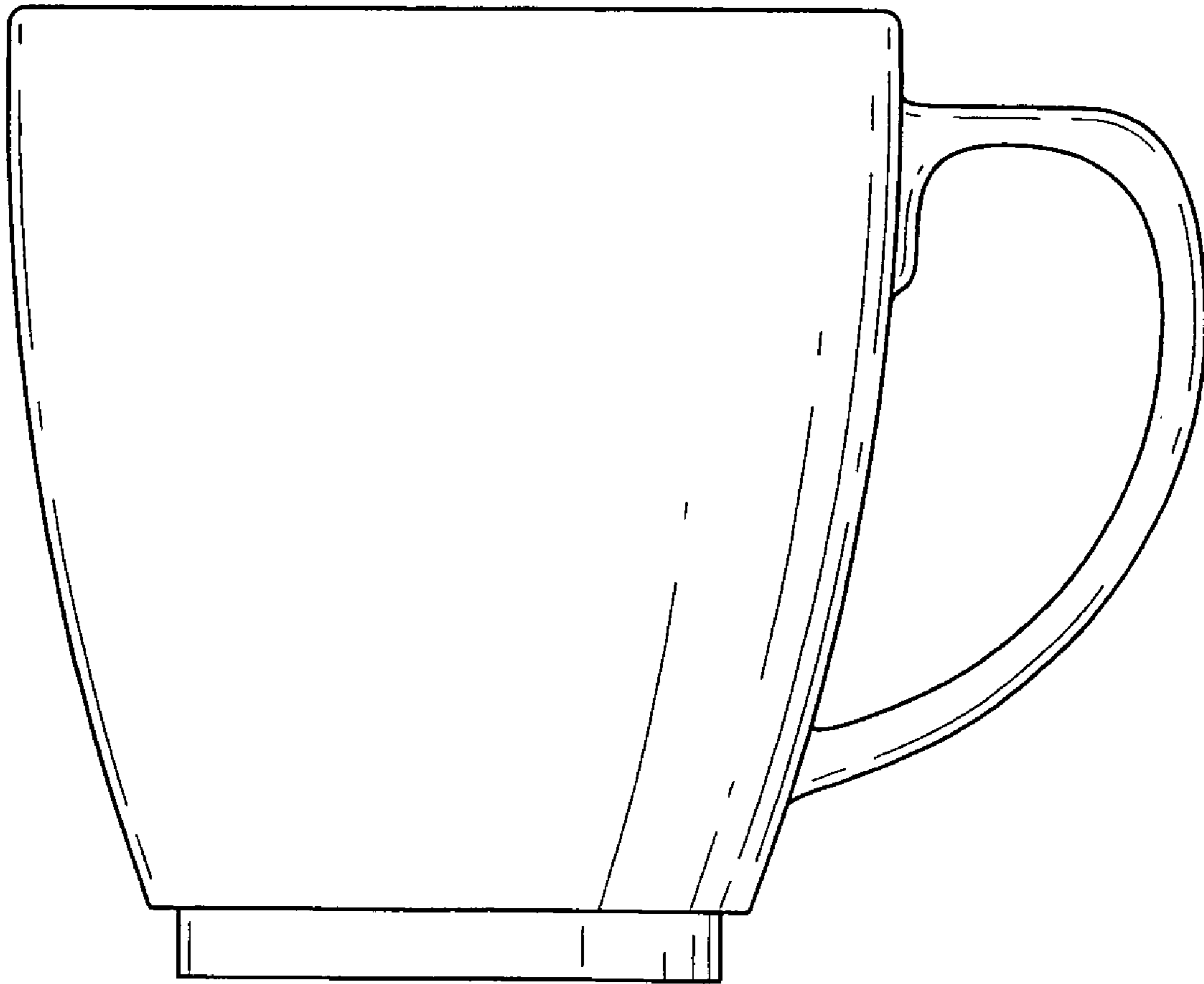

FIG. 2

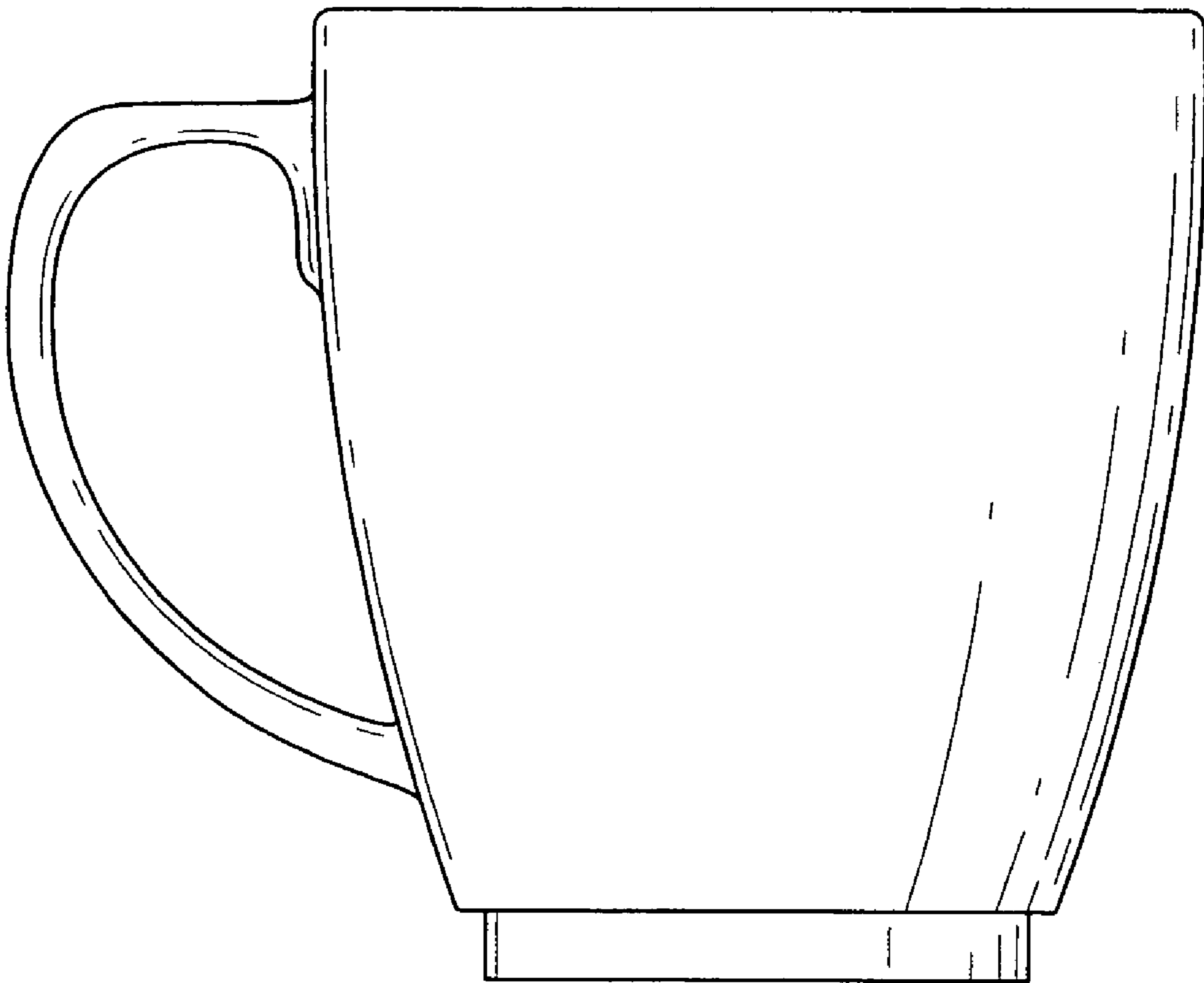

FIG. 3

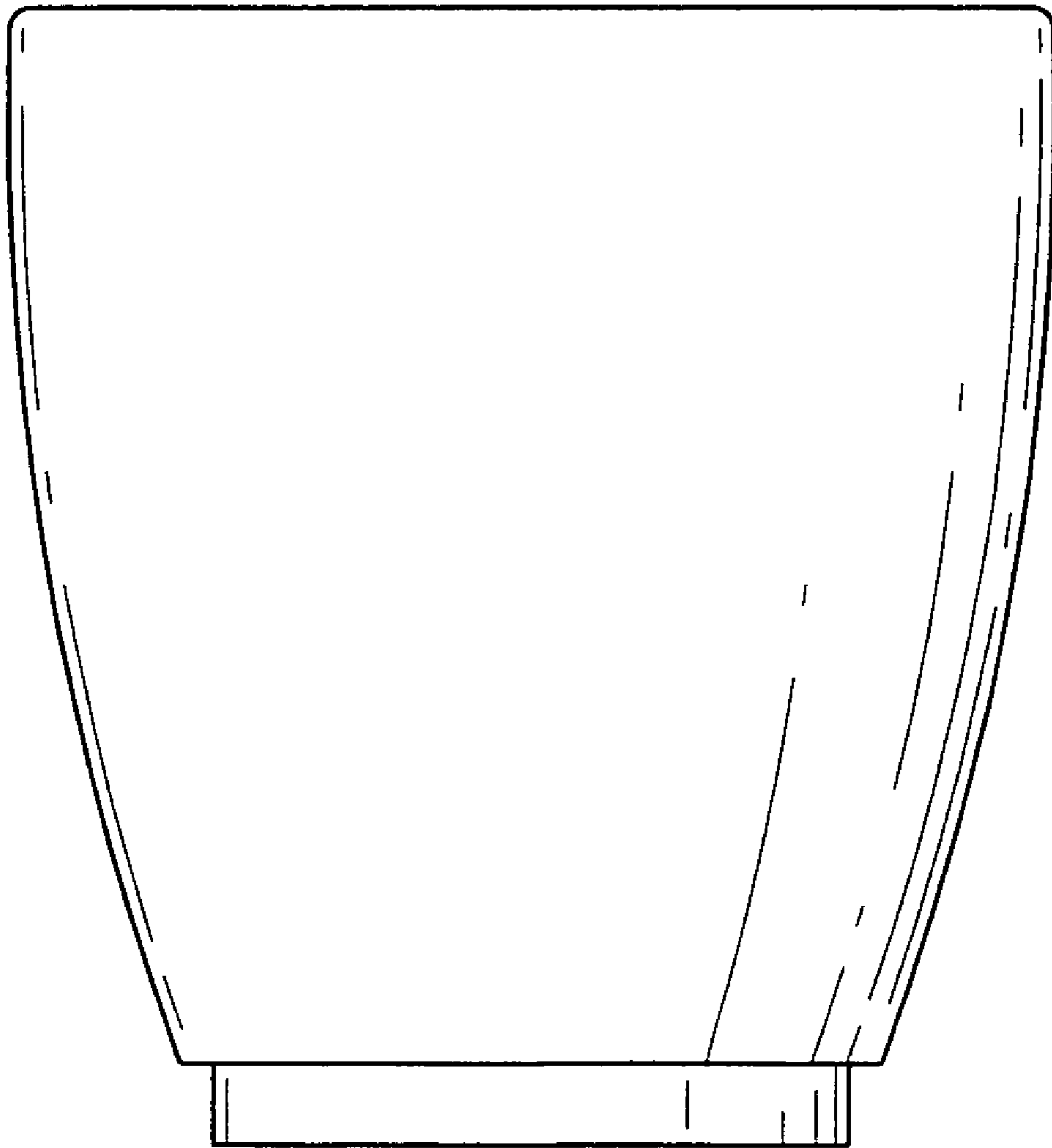

FIG. 4

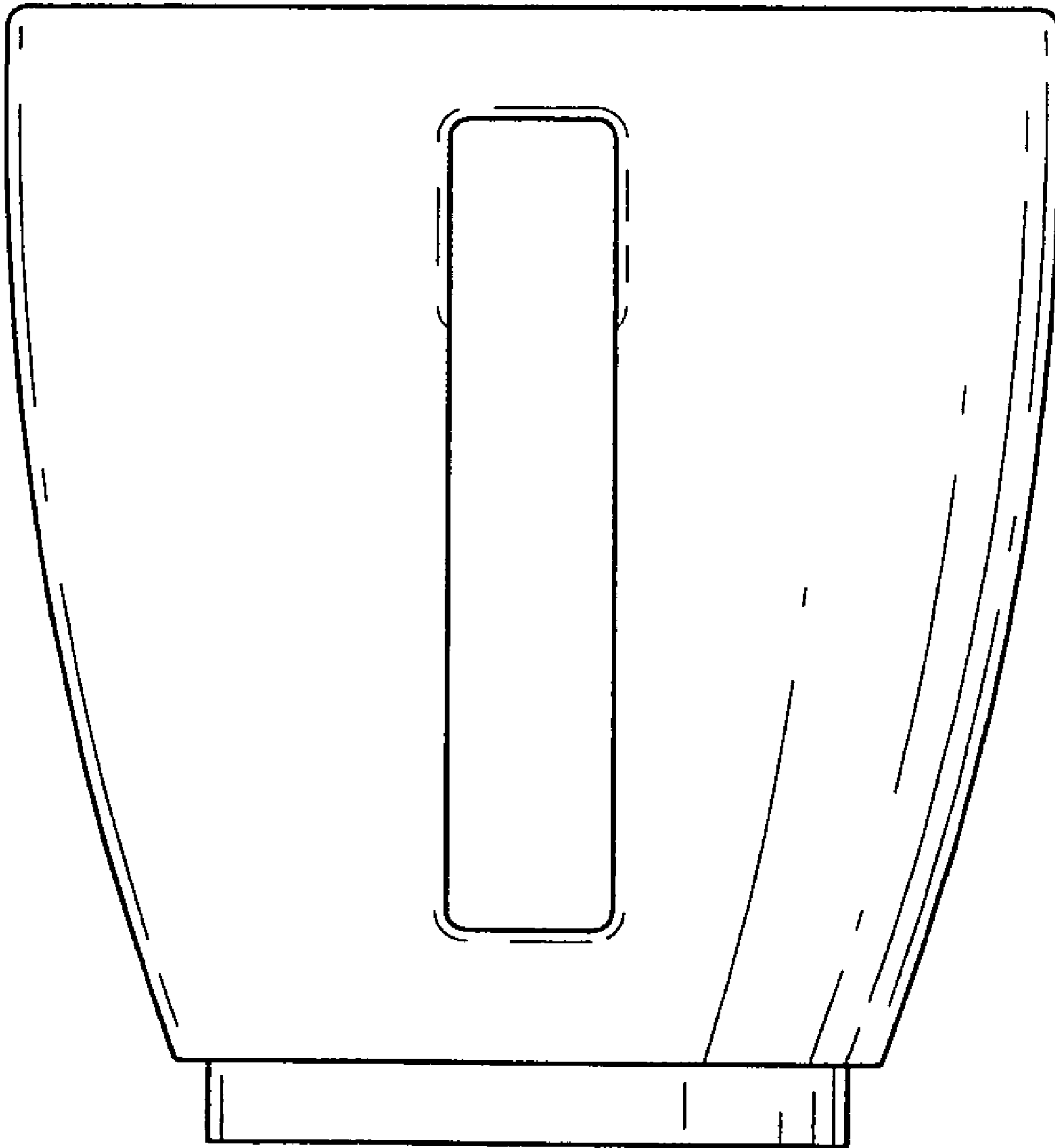

FIG. 5

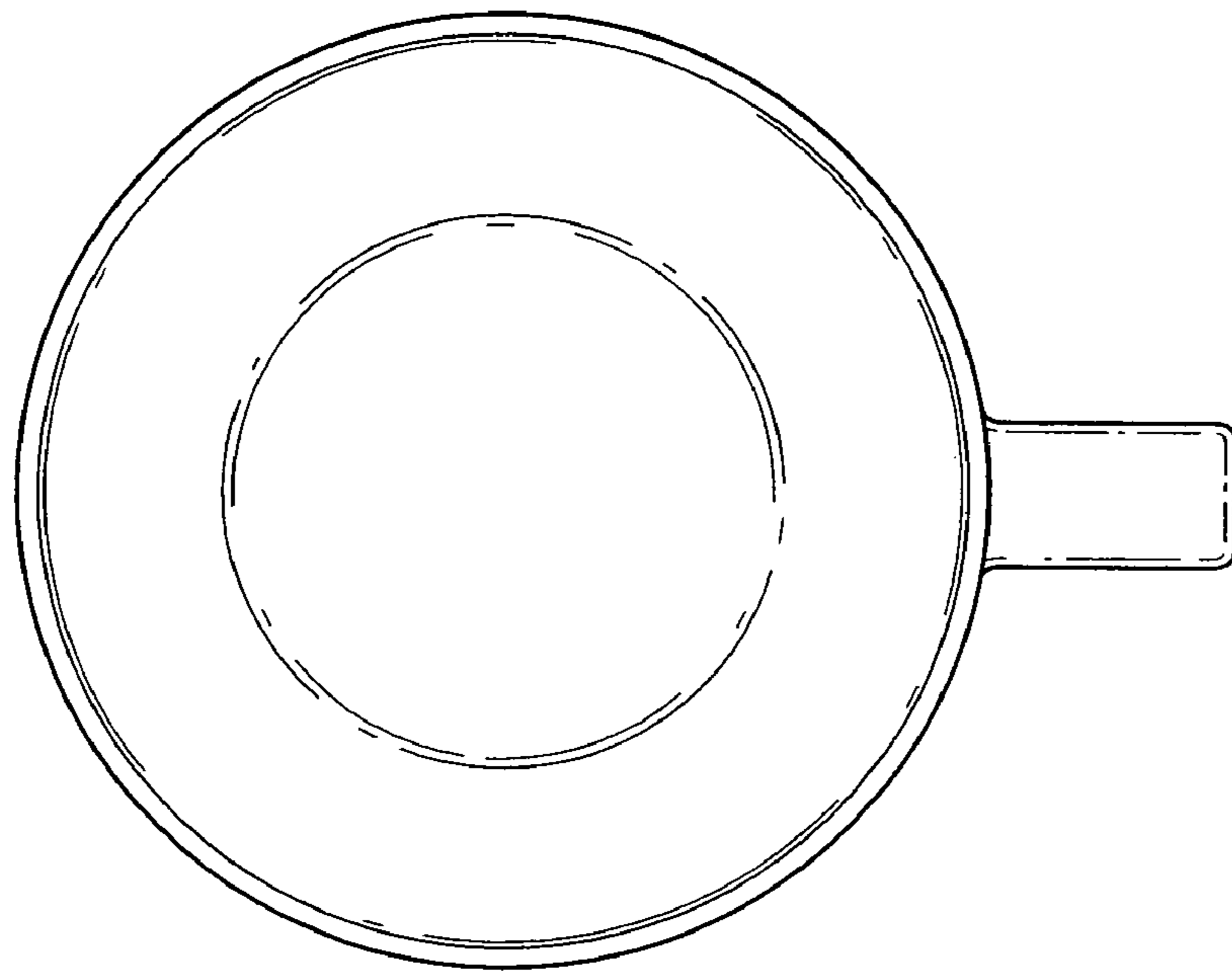

FIG. 6

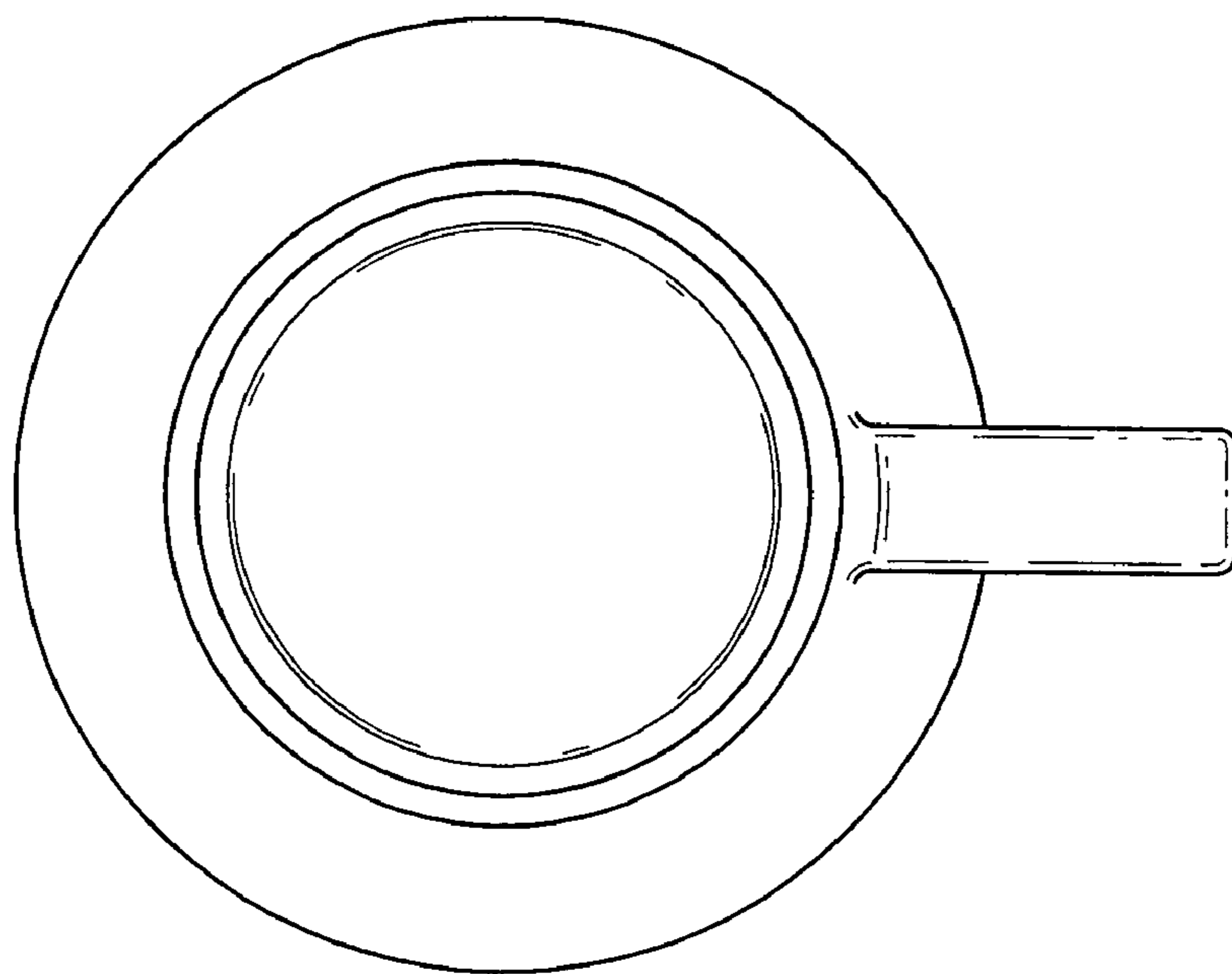

FIG. 7