



US00D549506S

(12) **United States Design Patent**  
**Stacy**

(10) **Patent No.:** **US D549,506 S**

(45) **Date of Patent:** **\*\* Aug. 28, 2007**

(54) **CLOTHING RACK**

(75) Inventor: **Laurel Anne Stacy**, East Greenwich,  
RI (US)

(73) Assignee: **Kenney Manufacturing Company**,  
Warwick, RI (US)

(\*\*) Term: **14 Years**

(21) Appl. No.: **29/232,266**

(22) Filed: **Jun. 16, 2005**

(51) **LOC (8) Cl.** ..... **06-04**

(52) **U.S. Cl.** ..... **D6/574**

(58) **Field of Classification Search** ..... D6/553,  
D6/567, 572, 574; 108/28-29; 248/235,  
248/309.1; 211/13.1, 42, 71.01, 86.01, 88.01,  
211/88.03, 90.01, 90.03, 126.1, 133.5, 134,  
211/153, 182

See application file for complete search history.

(56) **References Cited**

**U.S. PATENT DOCUMENTS**

- D282,995 S \* 3/1986 Beverly ..... D6/566
- D303,470 S \* 9/1989 Razumov ..... D6/546
- D406,484 S \* 3/1999 Wu ..... D6/566

- D477,957 S \* 8/2003 Mikich et al. .... D6/574
- D485,109 S \* 1/2004 Oberhaus ..... D6/574
- D485,464 S \* 1/2004 Clucas ..... D6/566

\* cited by examiner

*Primary Examiner*—Brian N. Vinson

(74) *Attorney, Agent, or Firm*—Barlow, Josephs & Holmes,  
Ltd.

(57) **CLAIM**

The ornamental design for a clothing rack, as shown and described.

**DESCRIPTION**

FIG. 1 is a perspective view of a clothing rack showing my new design;

FIG. 2 is a top view thereof;

FIG. 3 is a bottom view thereof

FIG. 4 is a front elevational view thereof;

FIG. 5 is a rear elevational view thereof;

FIG. 6 is a right side elevational view thereof; and,

FIG. 7 is a left side elevational view thereof.

**1 Claim, 7 Drawing Sheets**

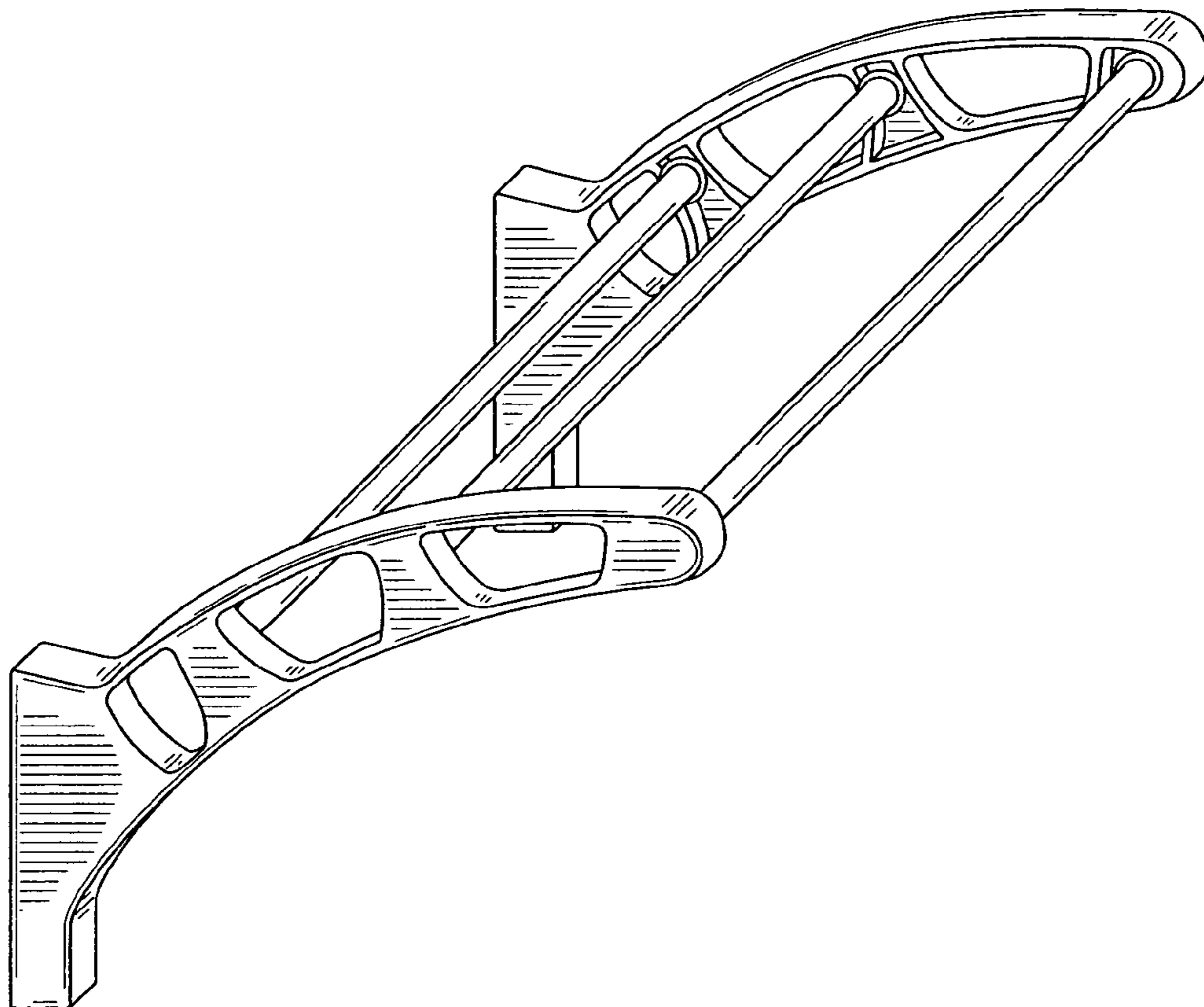

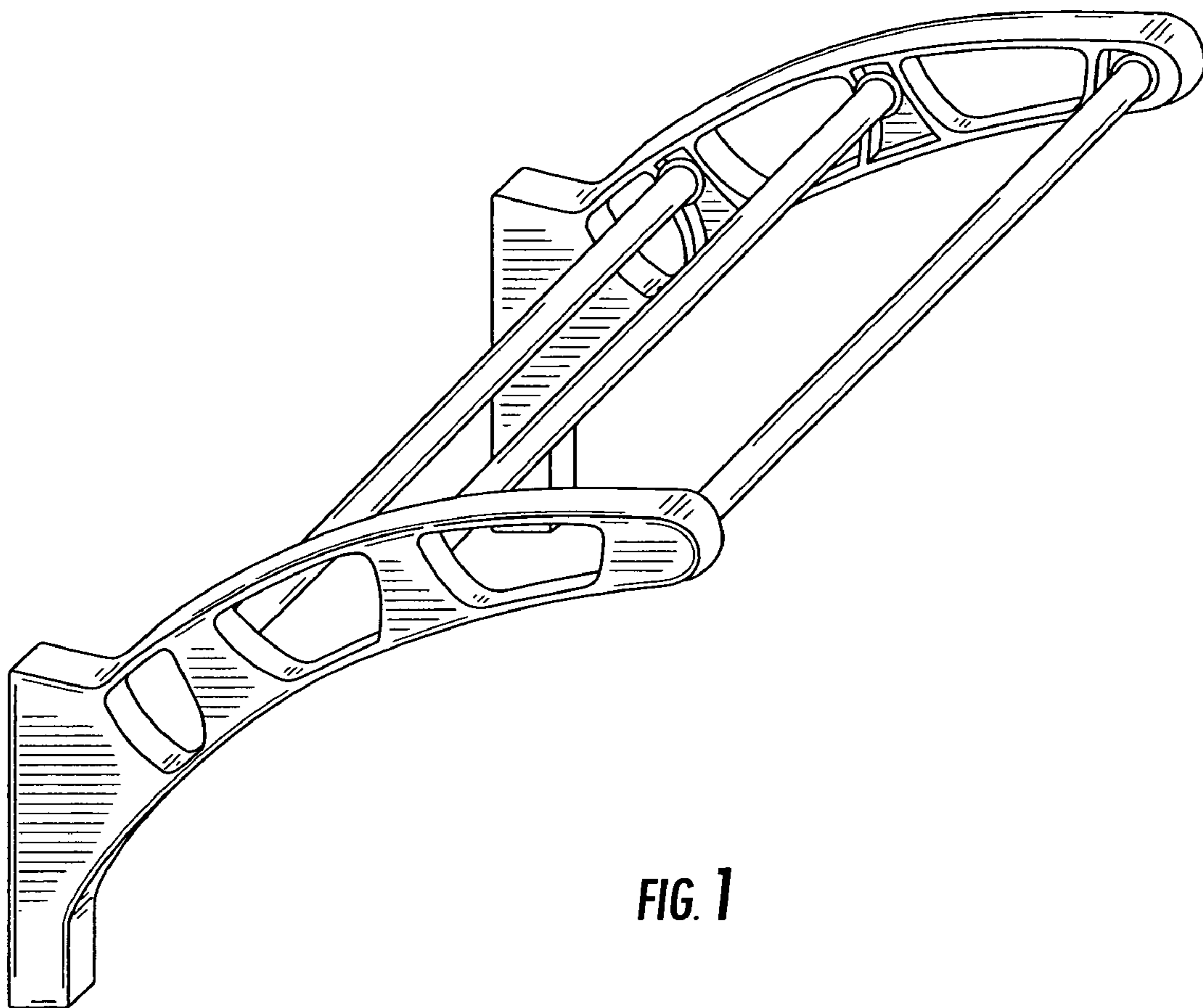

**FIG. 1**

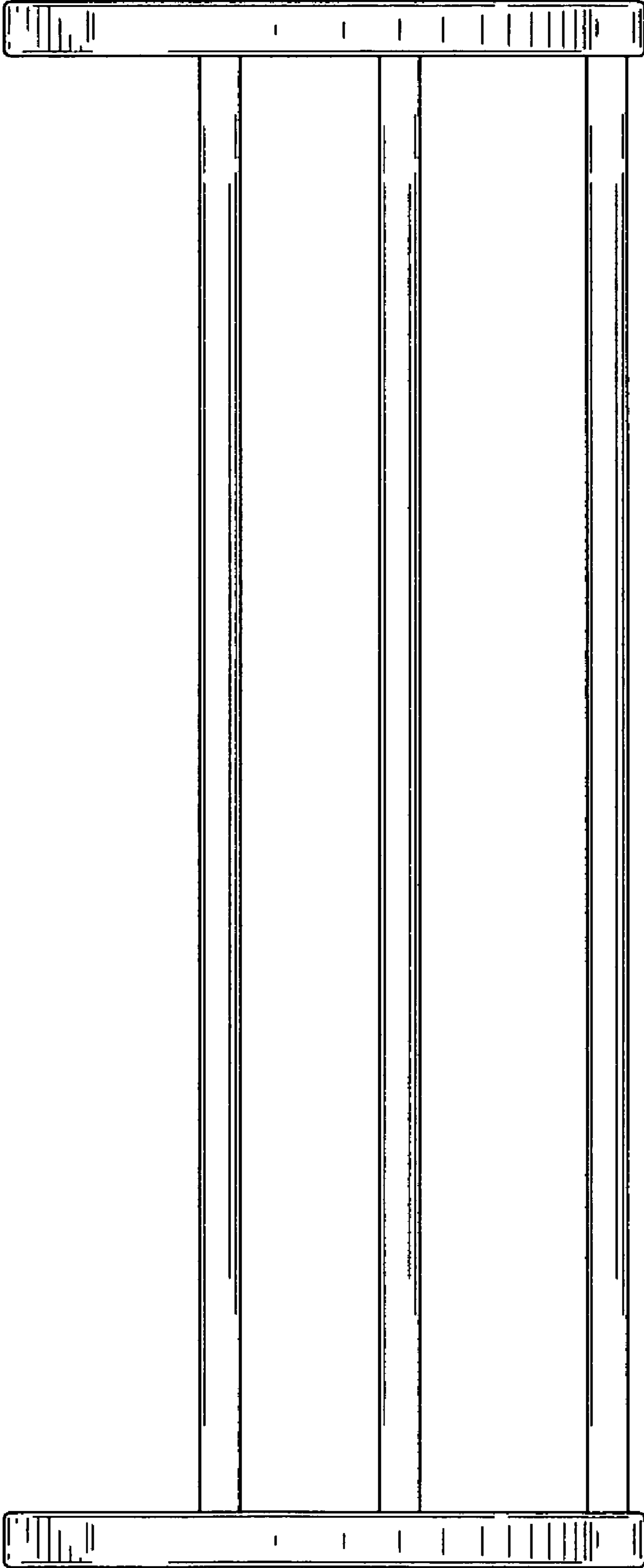

FIG. 2

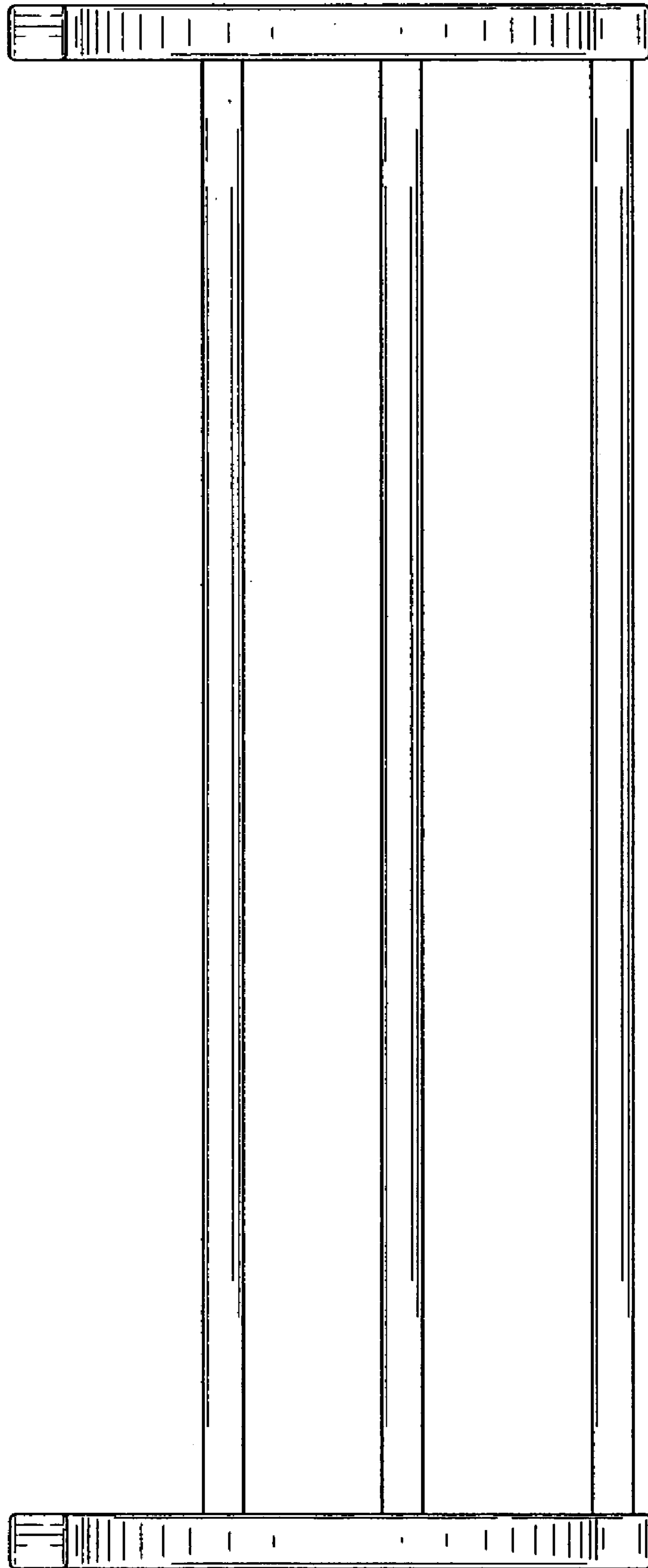

FIG. 3

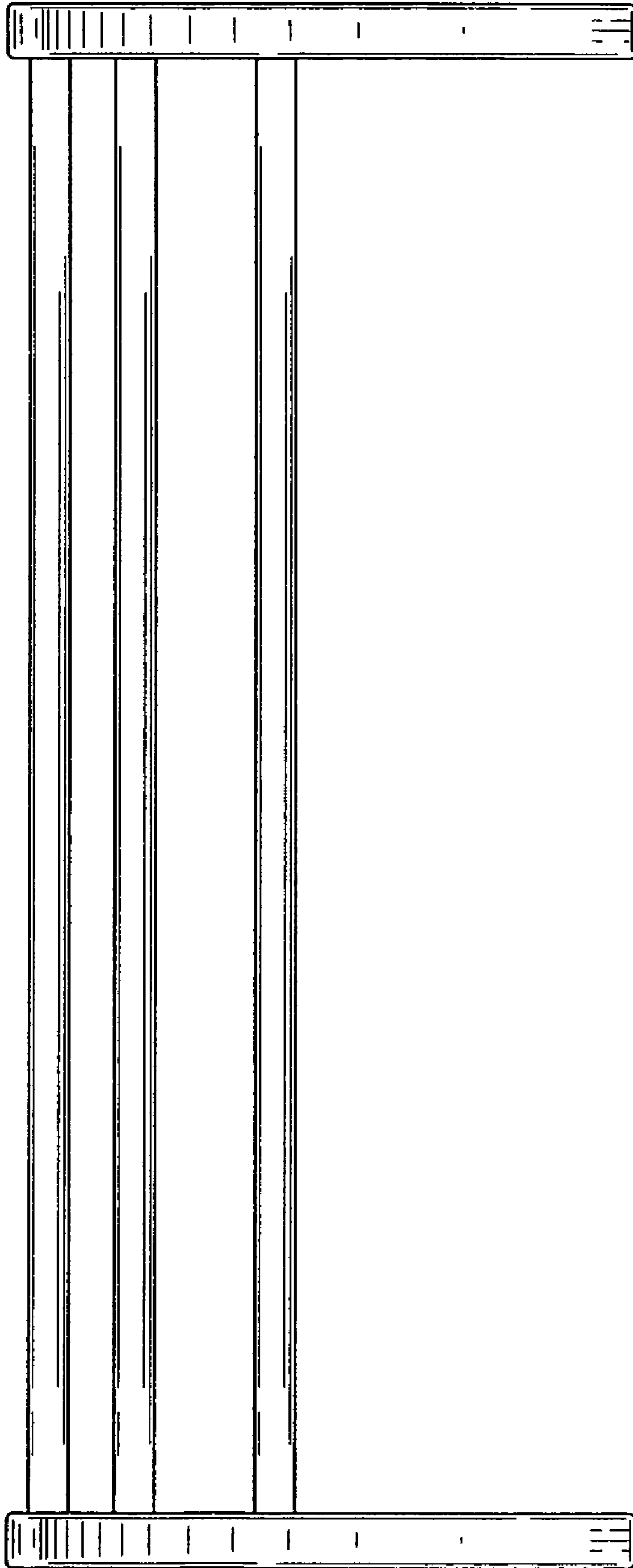

FIG. 4

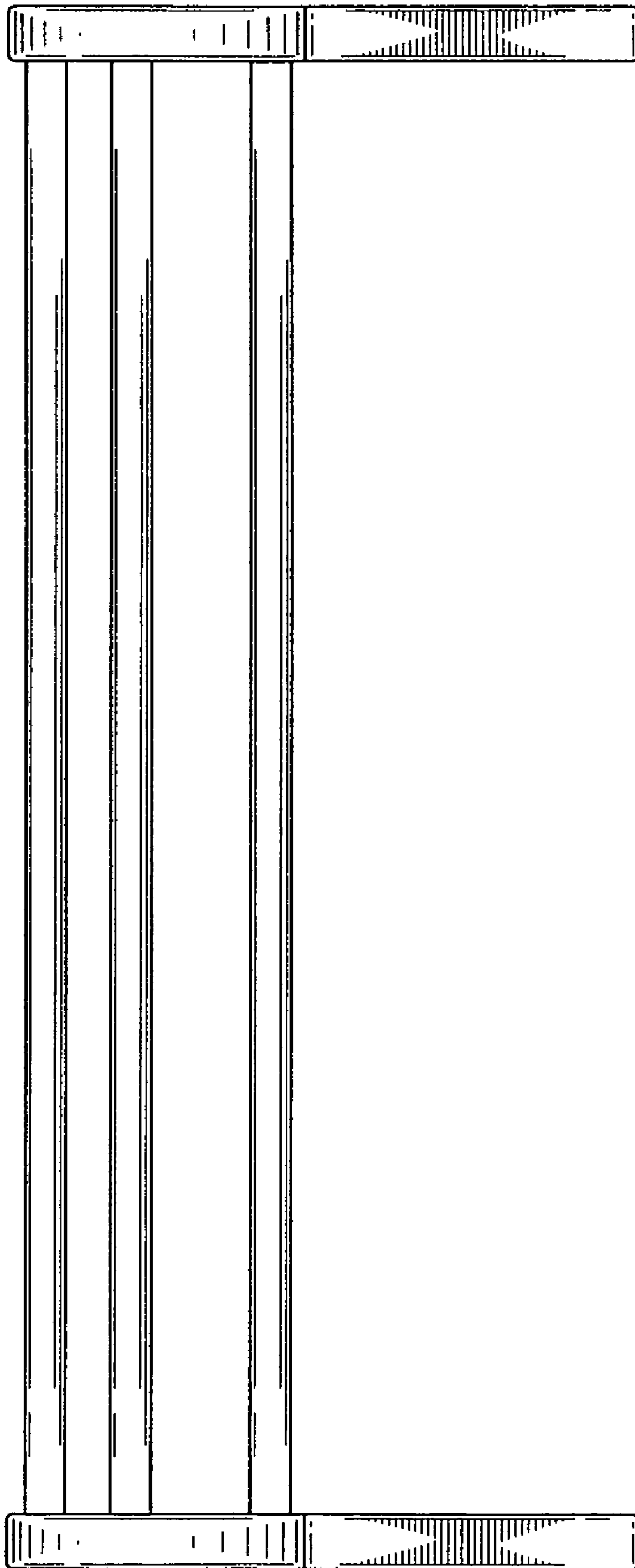
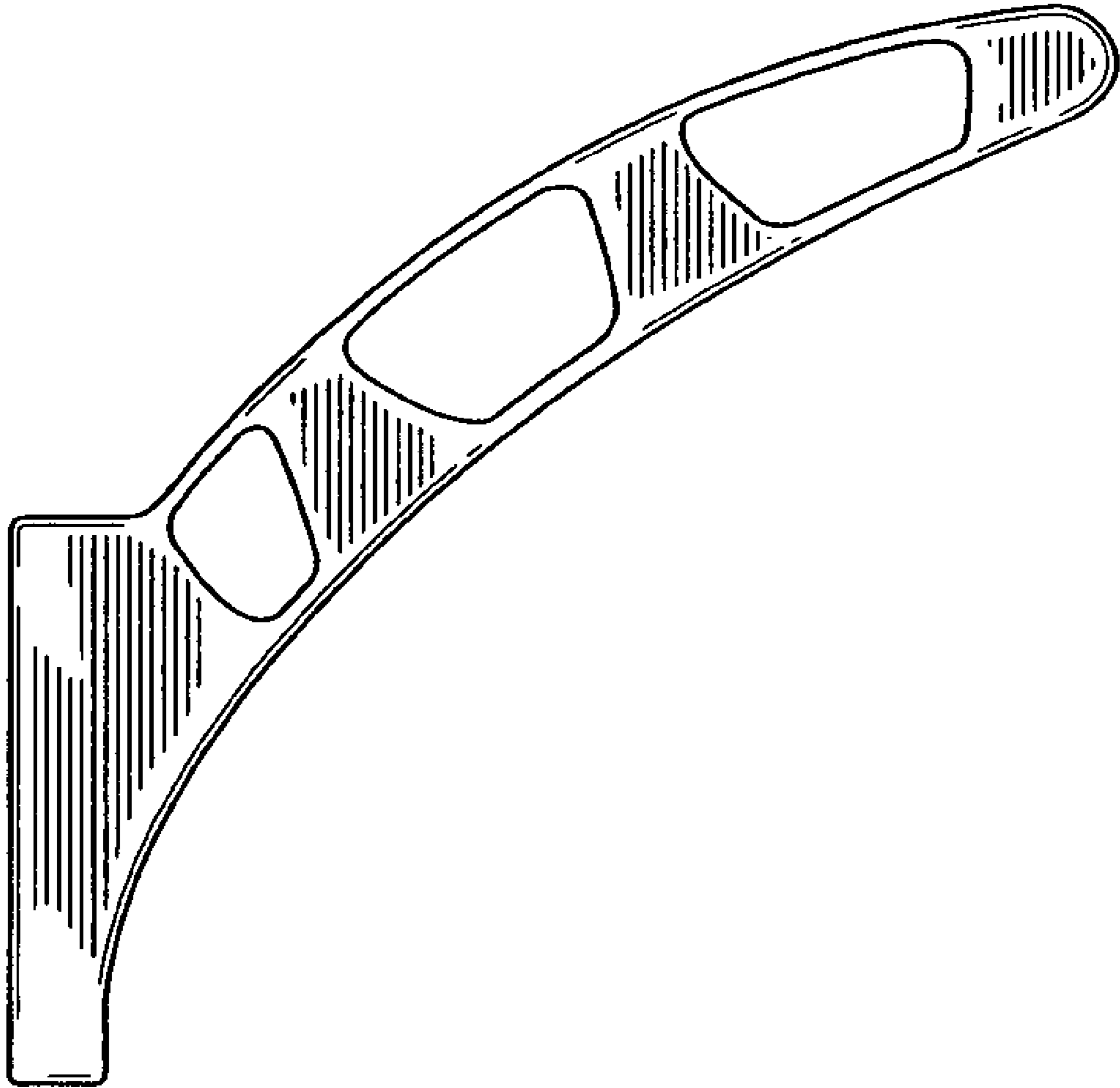
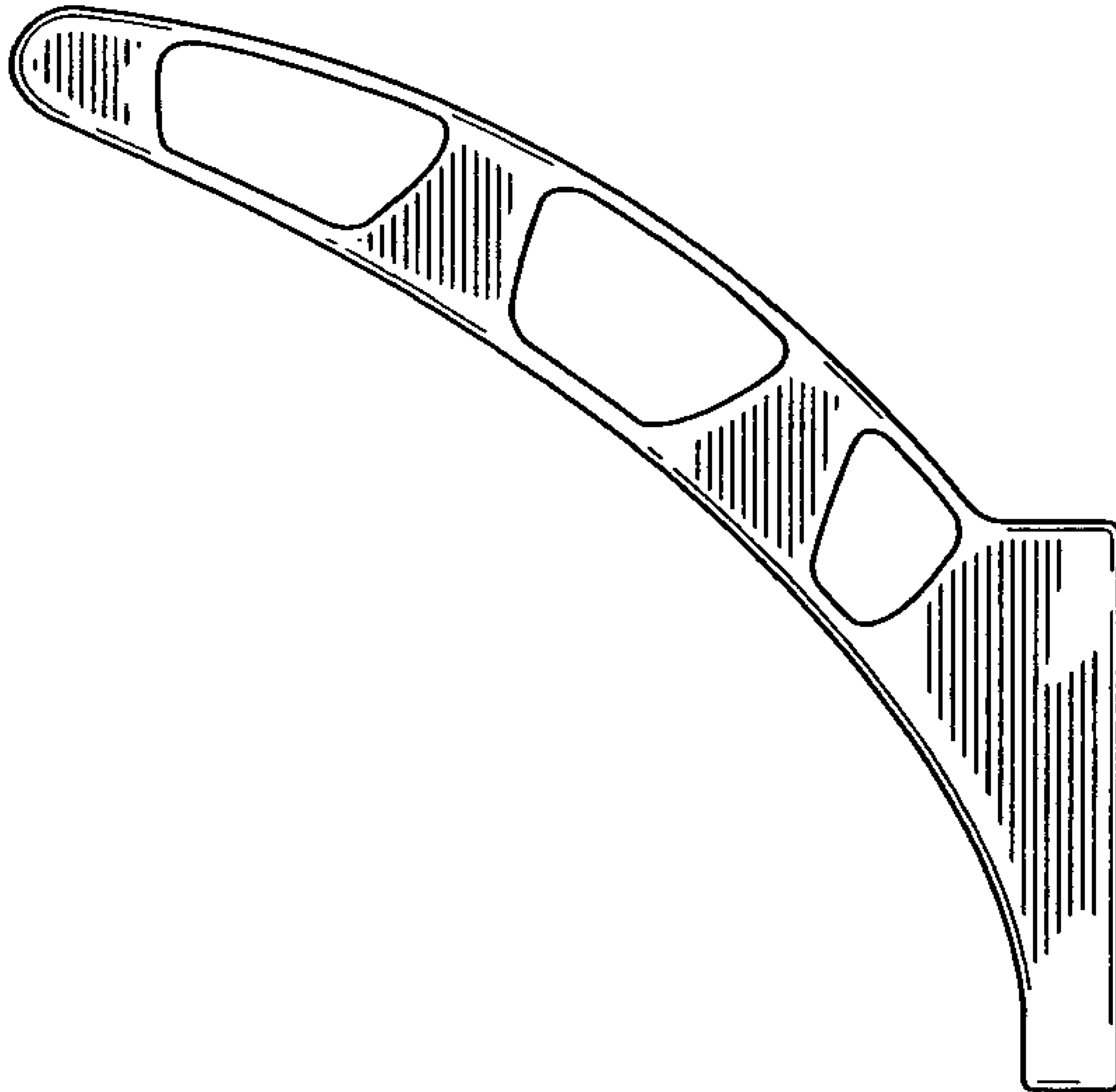

FIG. 5



**FIG. 6**



**FIG. 7**