

US00D549420S

(12) **United States Design Patent**
Naber

(10) **Patent No.:** **US D549,420 S**

(45) **Date of Patent:** **** Aug. 21, 2007**

(54) **CAN-SHAPED WASTE CONTAINER**

(75) Inventor: **Hans-Joachim Naber**, Nordhorn (DE)

(73) Assignee: **Naber Holding GmbH & Co. KG**

(**) Term: **14 Years**

(21) Appl. No.: **29/206,991**

(22) Filed: **Jun. 7, 2004**

(30) **Foreign Application Priority Data**

Dec. 22, 2003 (EM) 120126

(51) **LOC (8) Cl.** **09-09**

(52) **U.S. Cl.** **D34/9**

(58) **Field of Classification Search** D34/1,
D34/4, 6, 7, 8, 9, 10, 11; 220/262-264, 908-913;
D9/518, 503

See application file for complete search history.

(56) **References Cited**

U.S. PATENT DOCUMENTS

- D263,024 S * 2/1982 Atkinson et al. D9/780
- D327,093 S * 6/1992 Evenson D19/85
- D349,218 S * 8/1994 Evans D7/628
- D360,340 S * 7/1995 Hitch et al. D7/604
- D395,179 S * 6/1998 Primiano et al. D6/455

- D396,916 S * 8/1998 Ochs, Sr. D34/4
- D403,964 S * 1/1999 Jansen D9/772
- D442,995 S * 5/2001 Niiyama D20/10
- D451,027 S * 11/2001 Dugrot D9/772
- D473,428 S * 4/2003 Mak D7/606
- D522,880 S * 6/2006 Fuller et al. D9/729
- D524,091 S * 7/2006 Lai D7/332
- D530,685 S * 10/2006 Dupuis D14/125

* cited by examiner

Primary Examiner—Cynthia E. Ramirez

(74) *Attorney, Agent, or Firm*—Shlesinger & Fitzsimmons

(57) **CLAIM**

The ornamental design for the can-shaped waste container, as shown and described.

DESCRIPTION

FIG. 1 is a front view of the can-shaped waste container.
 FIG. 2 is a side view of the can-shaped waste container.
 FIG. 3 is a rear view of the can-shaped waste container.
 FIG. 4 is a bottom view of the can-shaped waste container.
 FIG. 5 is a top view of the can-shaped waste container; and,
 FIG. 6 is a side view of the can-shaped waste container showing the top of the container open.

1 Claim, 2 Drawing Sheets

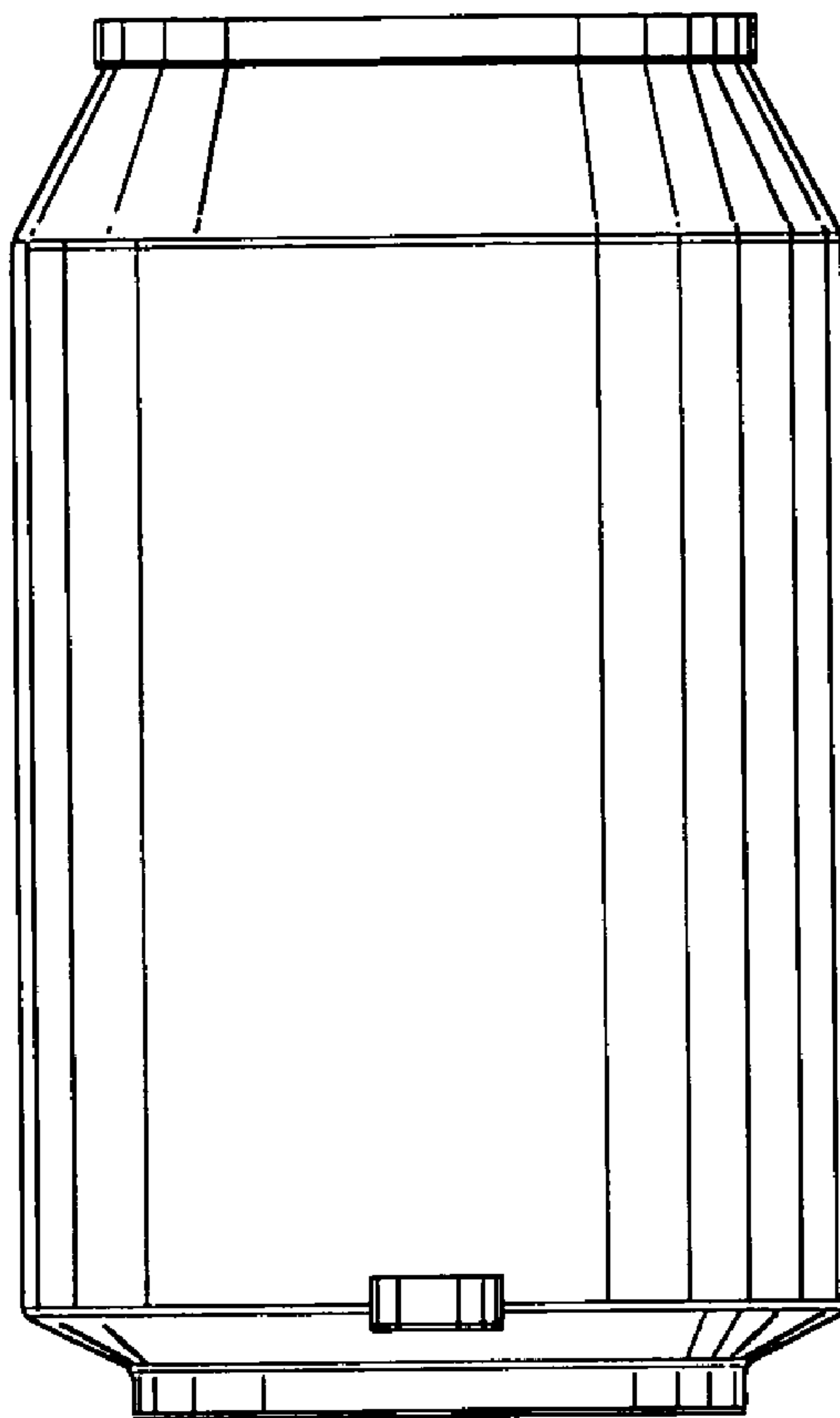

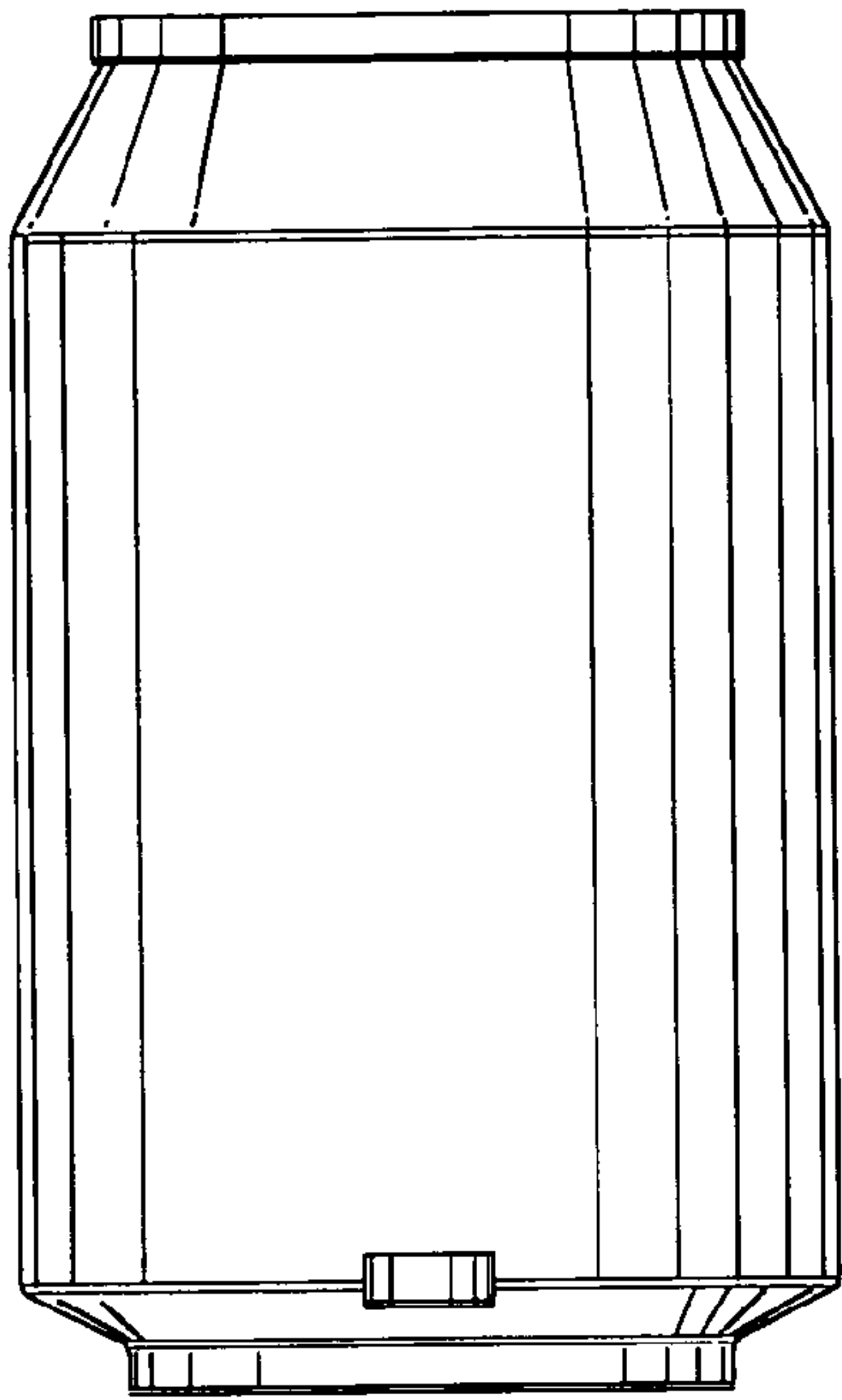

FIG. 1

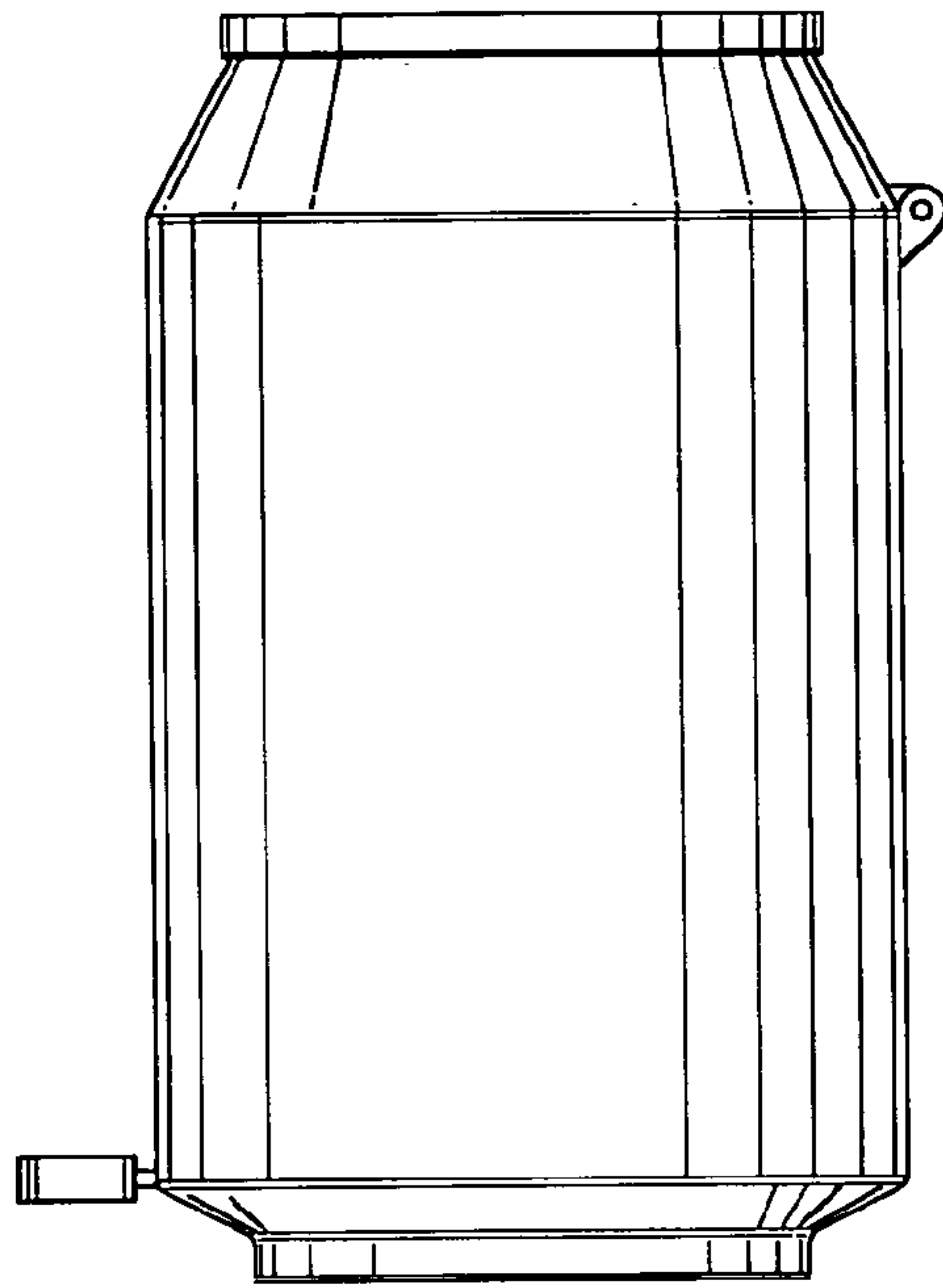

FIG. 2

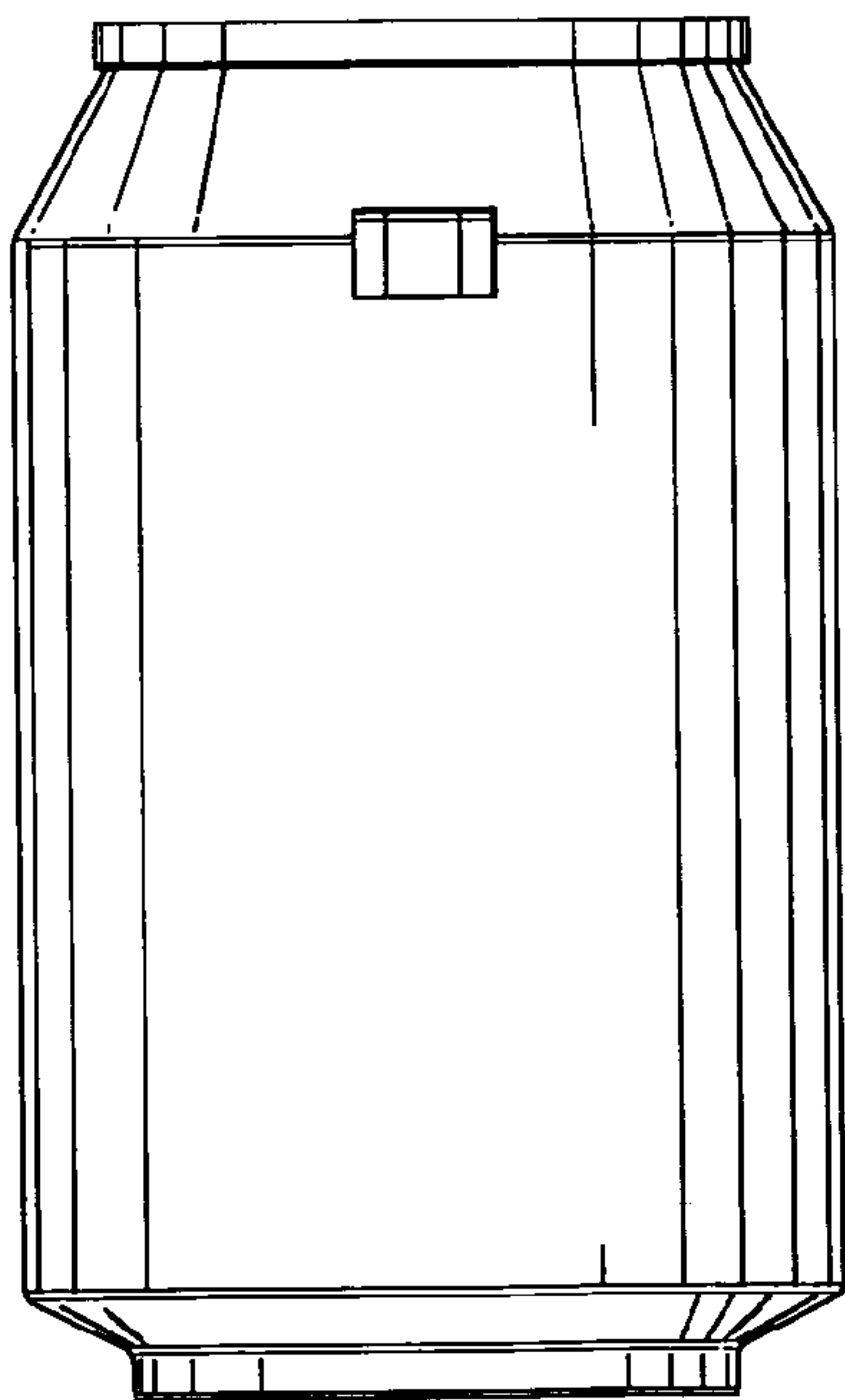

FIG. 3

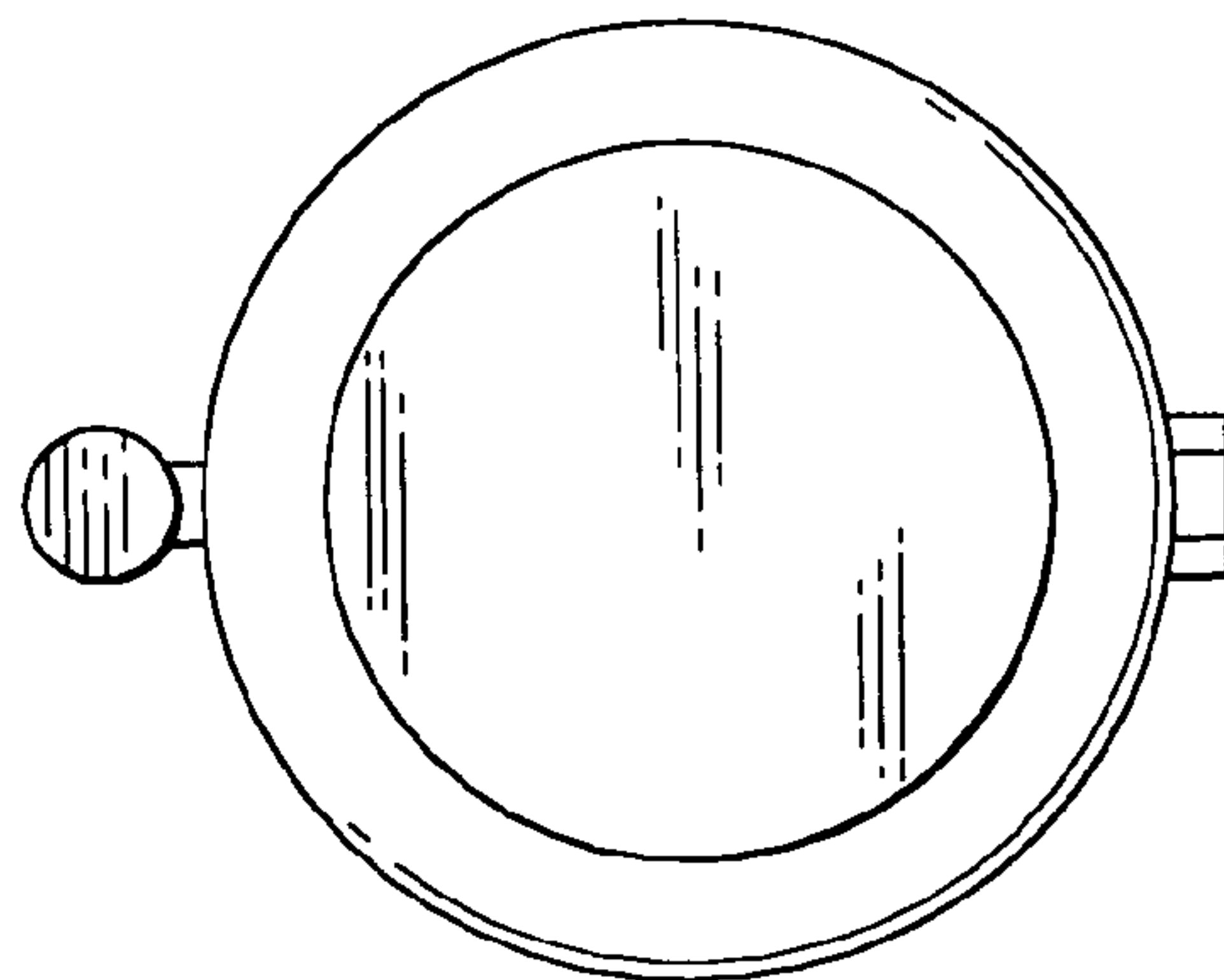

FIG. 4

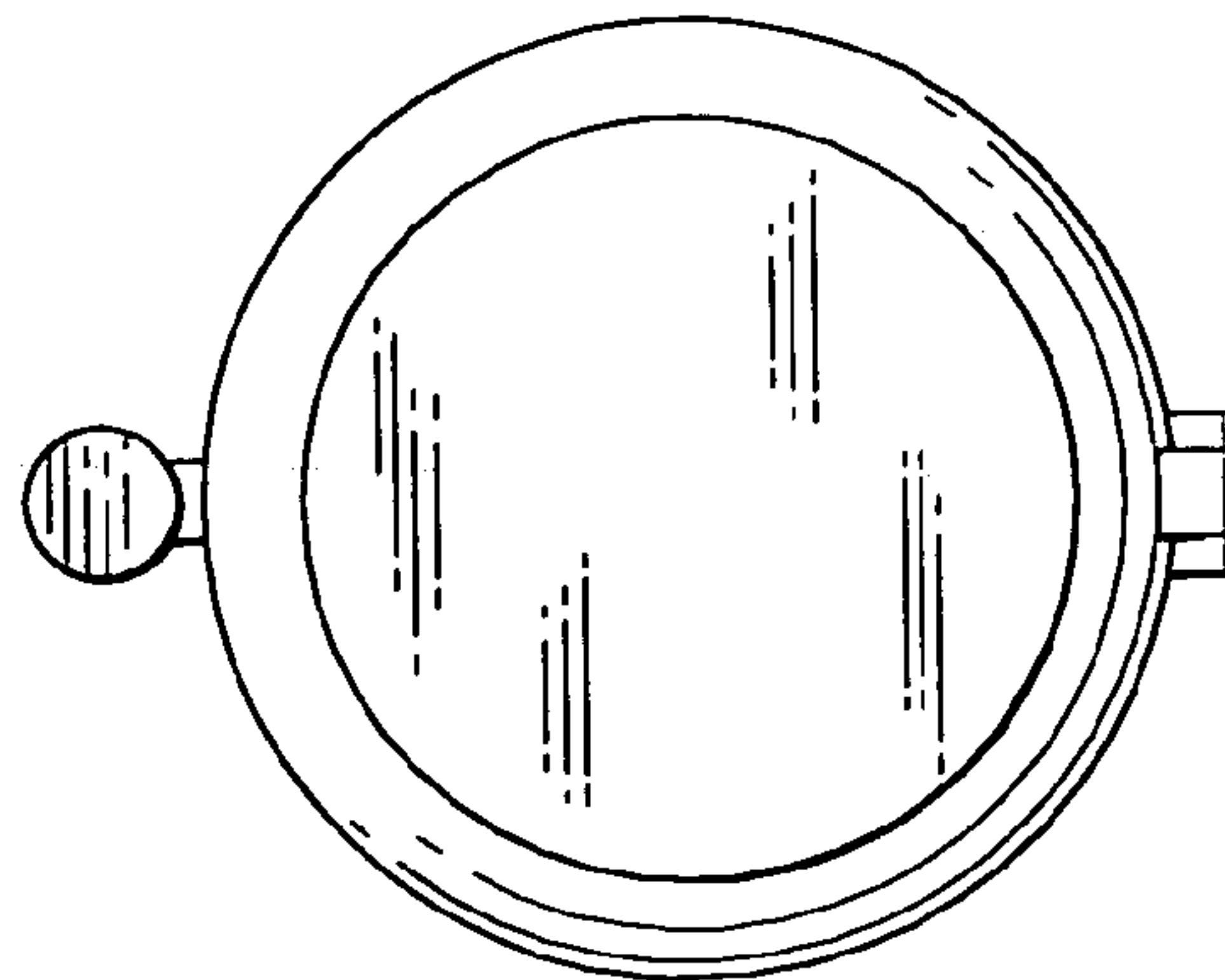

FIG. 5

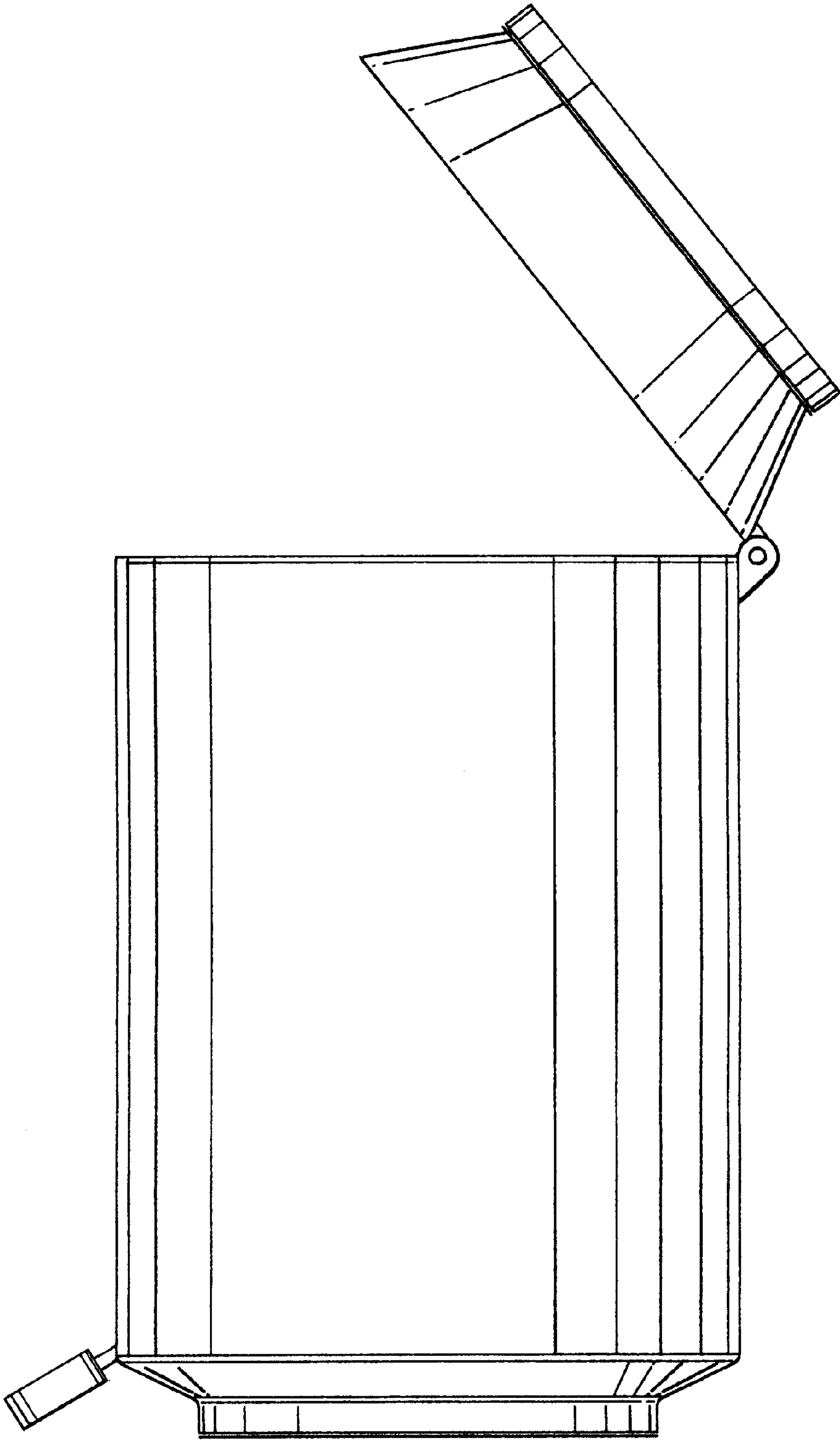

FIG. 6