

US00D549411S

(12) **United States Design Patent** (10) **Patent No.:** **US D549,411 S**  
**McNeeley et al.** (45) **Date of Patent:** **\*\* Aug. 21, 2007**

(54) **CLEANSING IMPLEMENT**

(75) Inventors: **Carolyn Marie McNeeley**, Brunswick Hills, OH (US); **Patrick William Brown**, Auburn, OH (US)

(73) Assignee: **Conopco, Inc.**, Englewood Cliffs, NJ (US)

(\*\*) Term: **14 Years**

(21) Appl. No.: **29/249,514**

(22) Filed: **Oct. 10, 2006**

(51) **LOC (8) Cl.** ..... **04-01**

(52) **U.S. Cl.** ..... **D32/45; D32/51; D32/40**

(58) **Field of Classification Search** ..... D32/49-51, D32/40-45; D28/63, 7; D4/127, 137-138; 15/244.1-244.4, 116.2, 118, 119.2, 143.1, 15/145, 147.1

See application file for complete search history.

(56) **References Cited**

**U.S. PATENT DOCUMENTS**

- D321,035 S \* 10/1991 Geneve et al. .... D23/223
- 5,138,735 A 8/1992 Kusz et al.
- D370,085 S \* 5/1996 MacGilvary ..... D28/7
- D371,219 S \* 6/1996 Bouchez ..... D28/7
- D381,771 S \* 7/1997 Chern ..... D28/63
- D392,432 S \* 3/1998 Henrie ..... D32/40
- D405,927 S \* 2/1999 Mallios ..... D28/63
- 5,893,836 A 4/1999 Raines
- D410,110 S \* 5/1999 Roland ..... D28/7
- D423,158 S \* 4/2000 La Liberty ..... D32/51
- D469,259 S \* 1/2003 Vosbikian ..... D4/138

- D473,343 S \* 4/2003 Carruba et al. .... D28/63
- D479,375 S \* 9/2003 Gringer et al. .... D32/48
- D480,215 S \* 10/2003 Mastroianni ..... D4/118
- D490,614 S \* 6/2004 Katz et al. .... D4/127
- D492,816 S 7/2004 Bergquist et al.
- D493,912 S \* 8/2004 Wong ..... D27/141
- D501,607 S \* 2/2005 Hay et al. .... D4/114
- D511,626 S \* 11/2005 Hay et al. .... D4/138
- D520,697 S \* 5/2006 Angeletta ..... D32/40
- 2006/0010625 A1 1/2006 Tapper et al.
- 2006/0168746 A1 8/2006 Guyuron et al.

\* cited by examiner

*Primary Examiner*—Pamela J. Burgess

(74) *Attorney, Agent, or Firm*—Alan A. Bornstein

(57) **CLAIM**

The ornamental design for a cleansing implement, as shown and described.

**DESCRIPTION**

FIG. 1 is a front perspective view of a cleansing implement showing our new design;

FIG. 2 is a front elevational view thereof;

FIG. 3 is a rear elevational view thereof;

FIG. 4 is a right side elevational view thereof;

FIG. 5 is a left side elevational view thereof;

FIG. 6 is a top plan view thereof; and,

FIG. 7 is a bottom plan view thereof.

The broken line showing is for illustrative purposes only and forms no part of the claimed design.

**1 Claim, 3 Drawing Sheets**

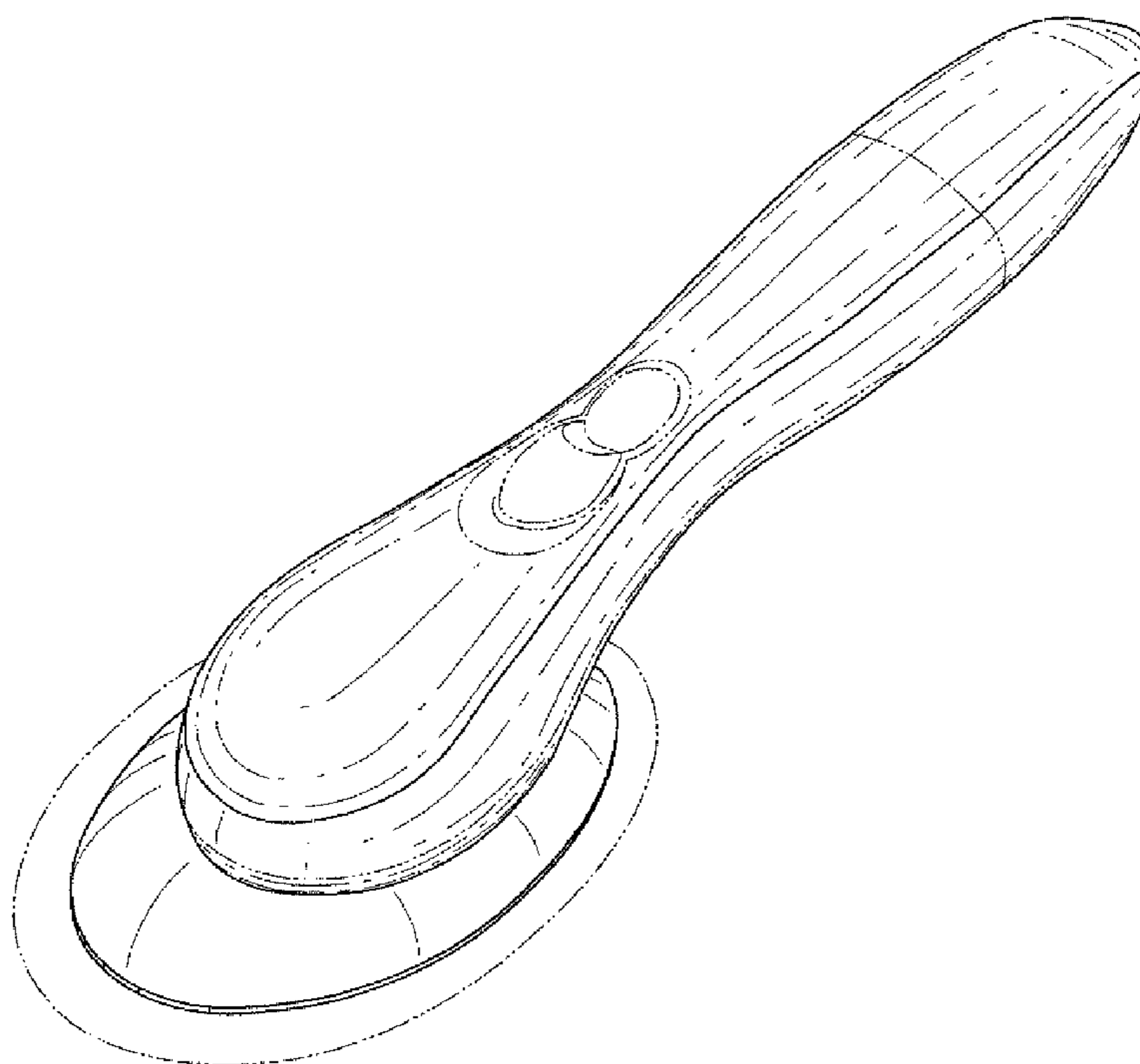

FIG. 1

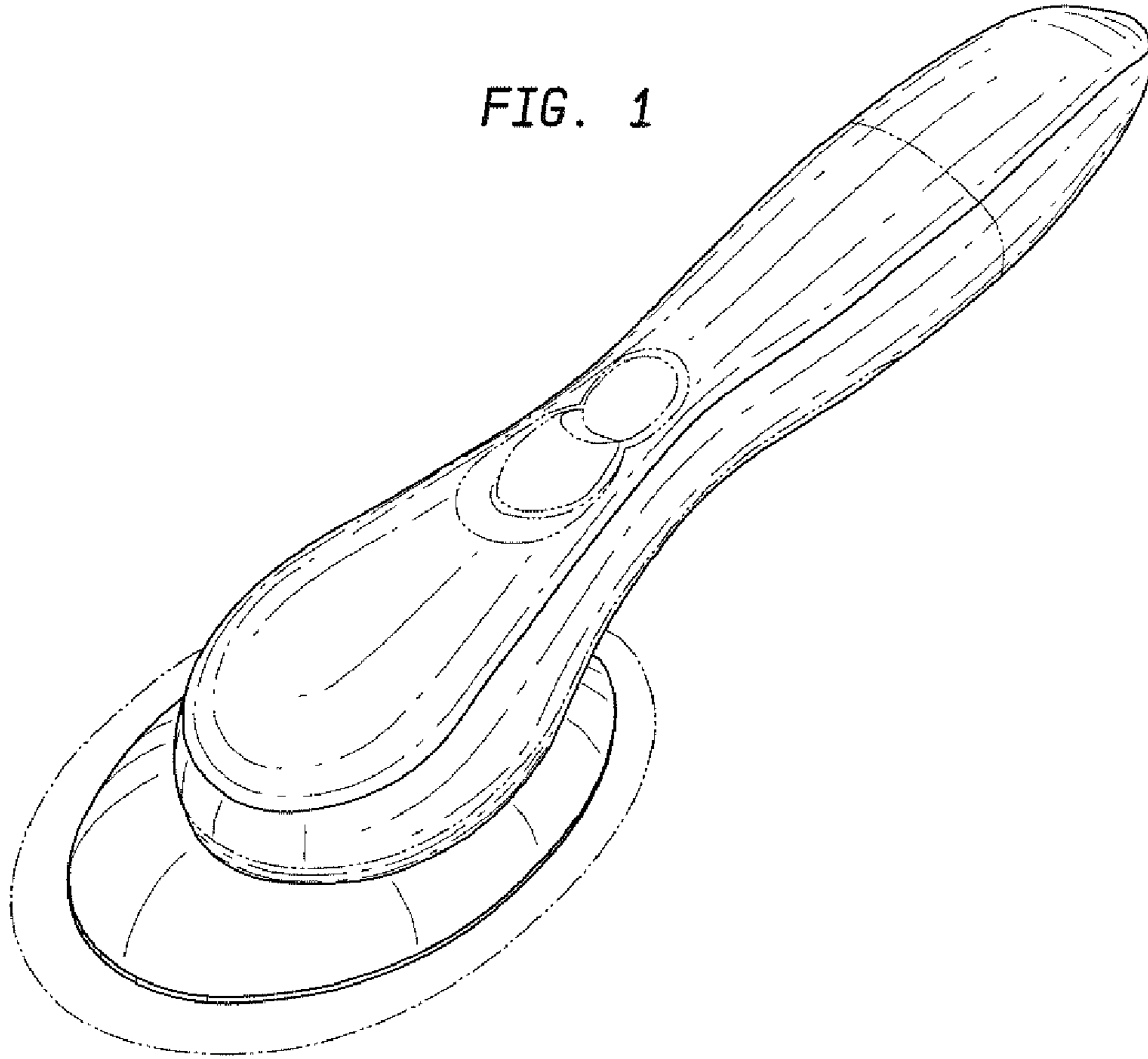

FIG. 2

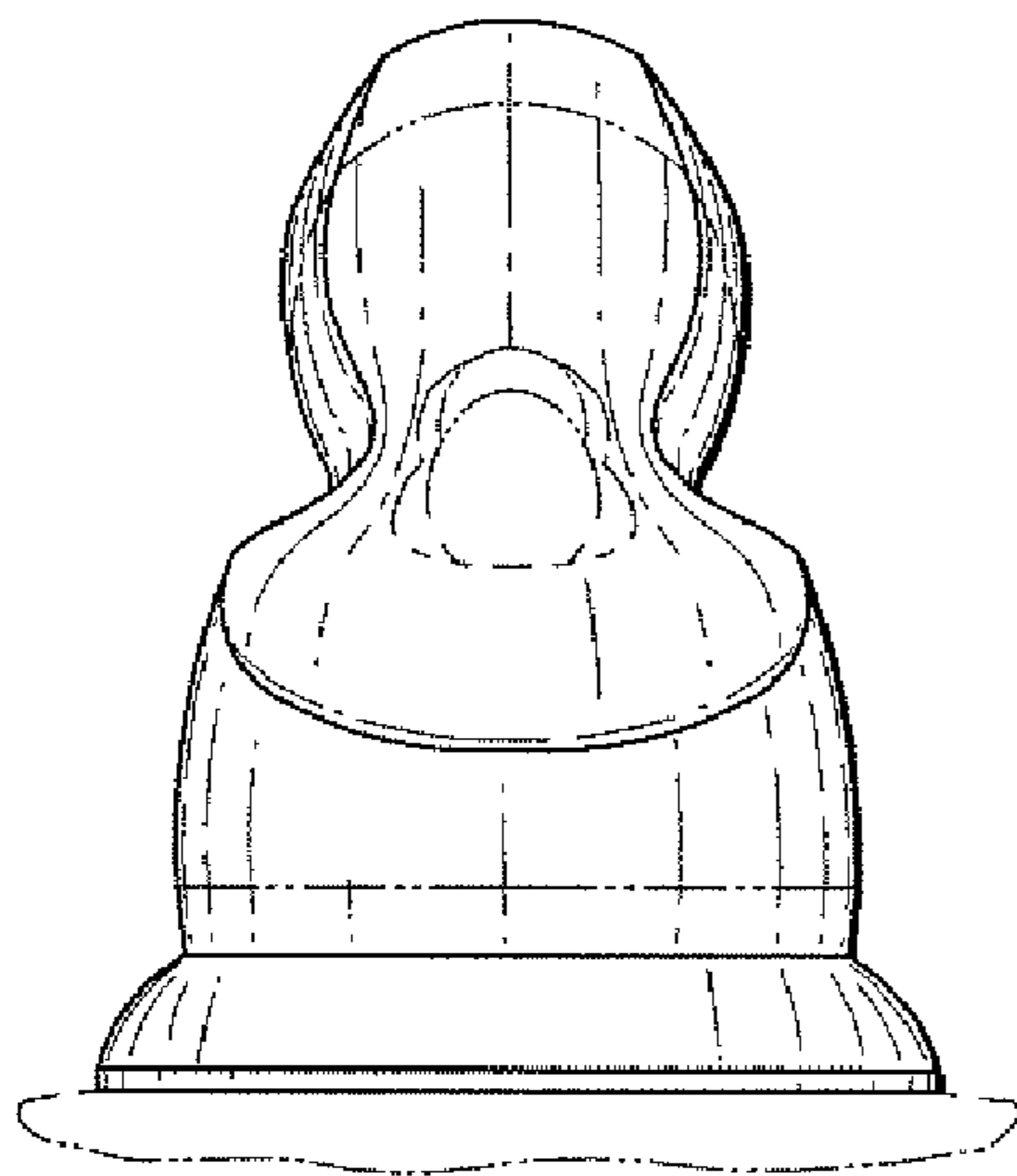
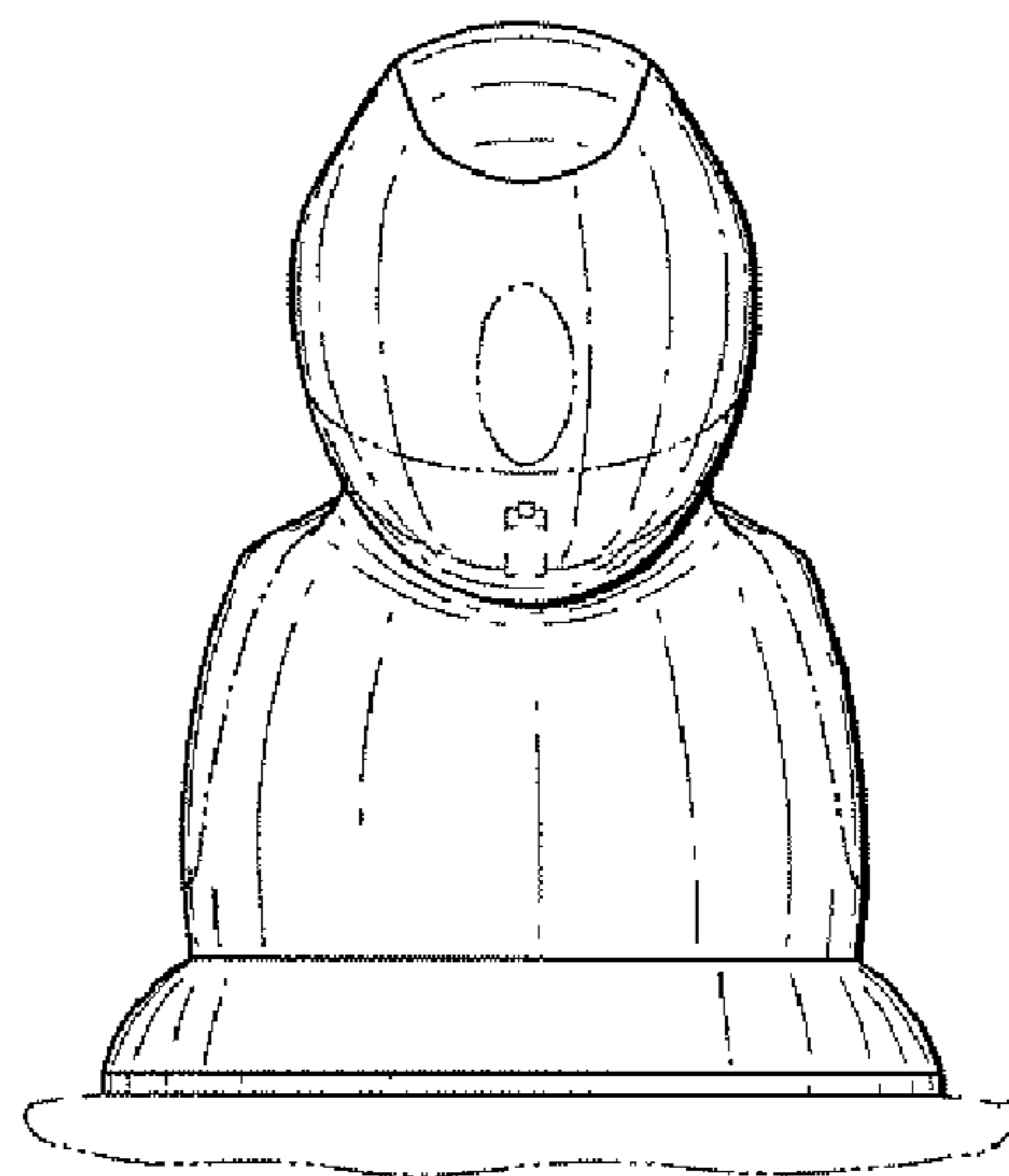

FIG. 3



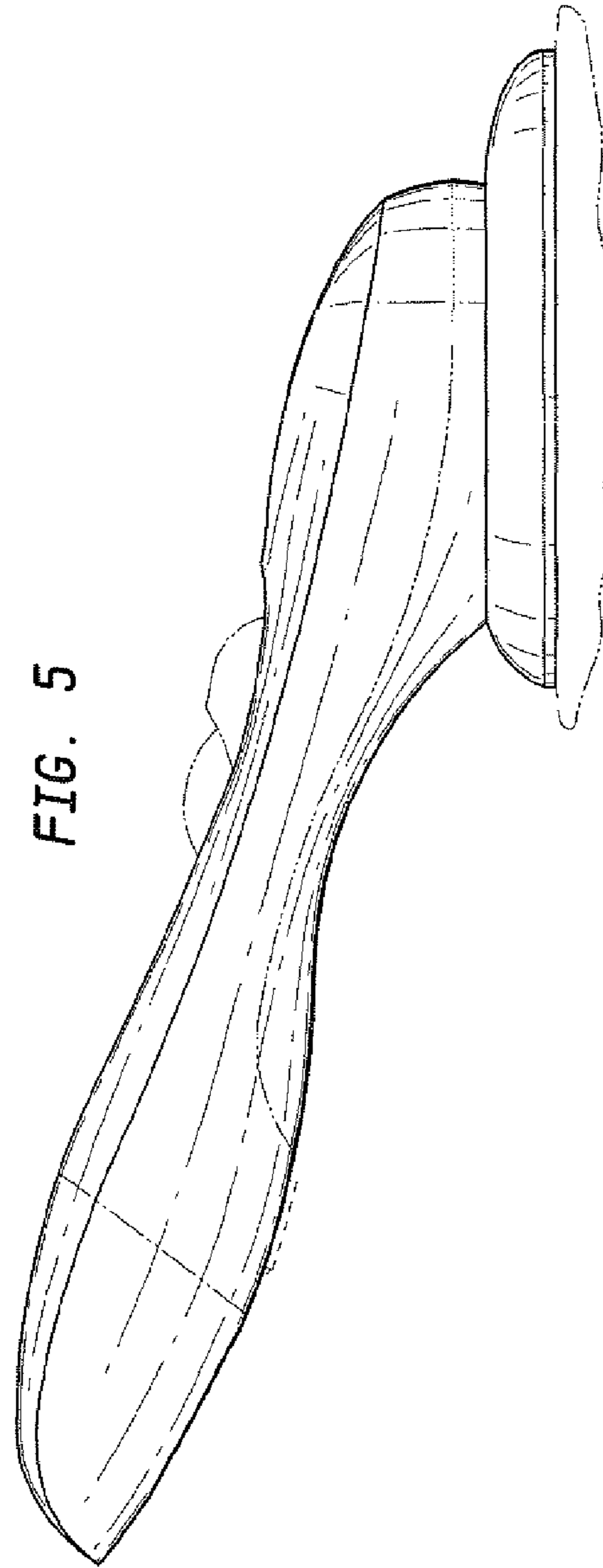
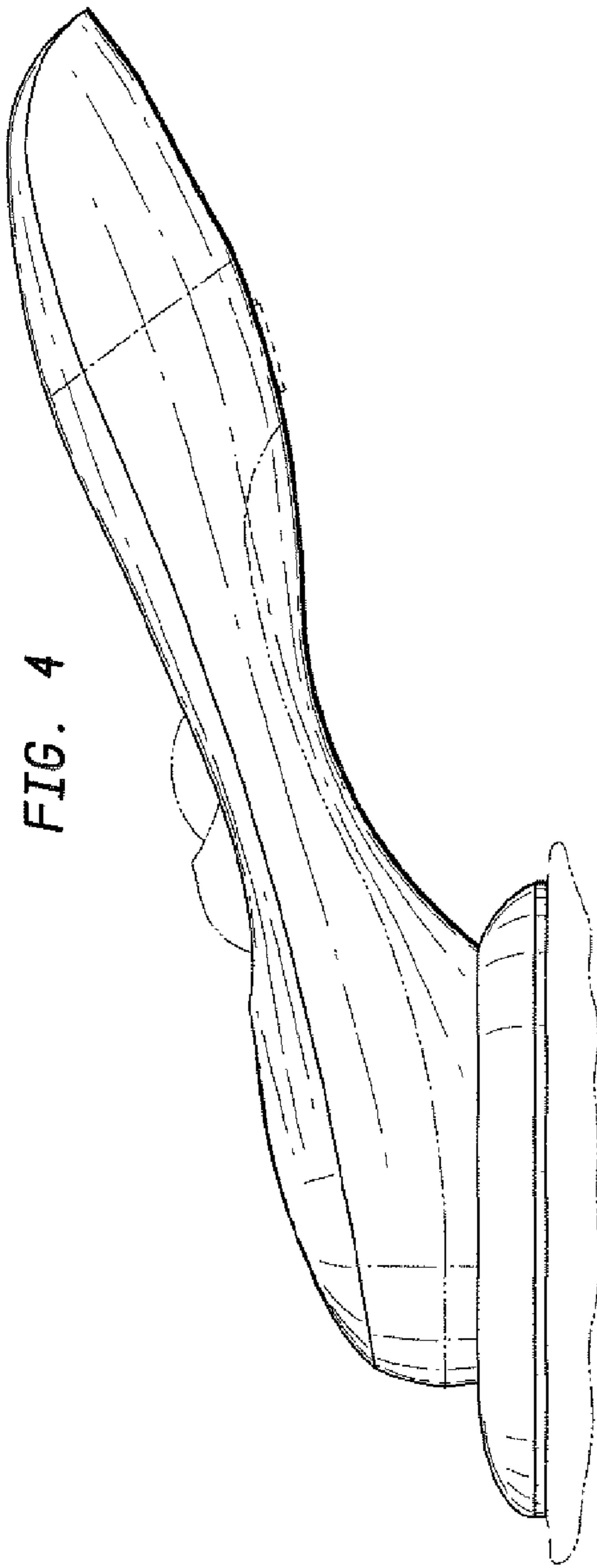

FIG. 6

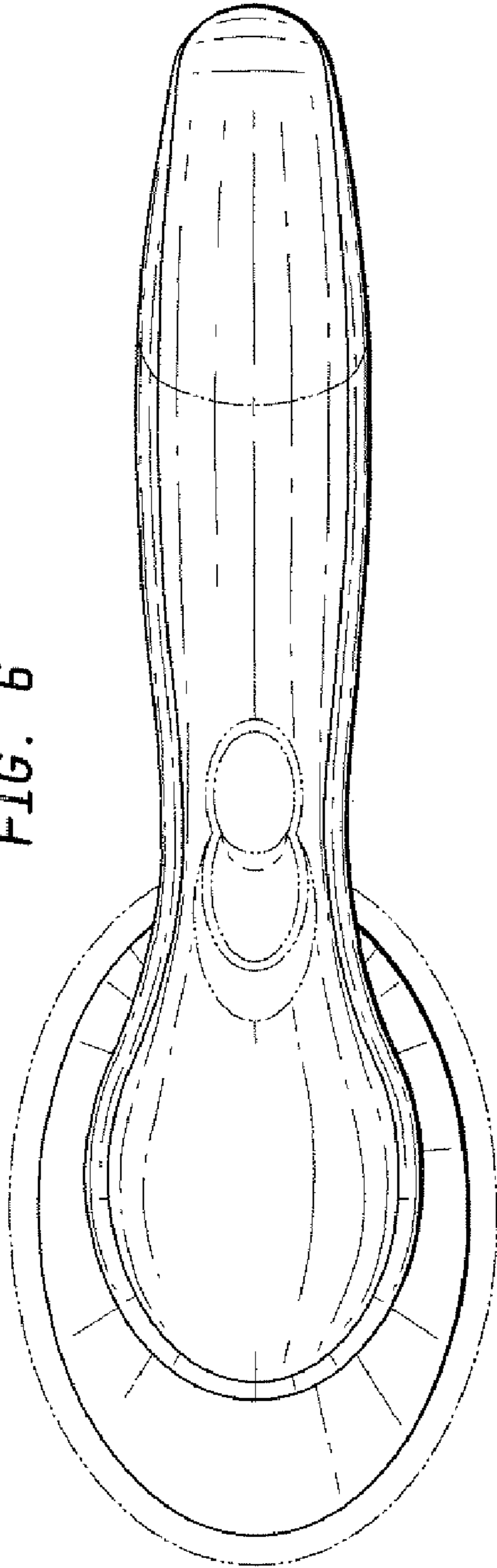

FIG. 7

