

US00D549366S

(12) **United States Design Patent** (10) **Patent No.:** **US D549,366 S**  
**Hovind et al.** (45) **Date of Patent:** **\*\* Aug. 21, 2007**

(54) **VEHICLE INTERIOR LIGHT**

(57) **CLAIM**

(75) Inventors: **Steven H. Hovind**, Bellevue, WA (US);  
**Wallace A. Peltola**, Sammamish, WA  
(US); **Andy King-Pui Wong**, Seattle,  
WA (US)

The ornamental design for a vehicle interior light, as shown  
and described.

(73) Assignee: **PACCAR Inc**, Bellevue, WA (US)

**DESCRIPTION**

(\*\*) Term: **14 Years**

FIG. 1 is a front perspective view of the top of a vehicle  
interior light showing our new design;

(21) Appl. No.: **29/276,212**

FIG. 2 is a front perspective view of the bottom of the  
vehicle interior light of FIG. 1;

(22) Filed: **Jan. 18, 2007**

FIG. 3 is a top plan view of the vehicle interior light of FIG.  
1;

(51) **LOC (8) Cl.** ..... **26-06**

(52) **U.S. Cl.** ..... **D26/28**

(58) **Field of Classification Search** ..... D26/28-36;  
362/61, 74, 80, 83, 216-224, 404, 432  
See application file for complete search history.

FIG. 4 is a bottom plan view of the vehicle interior light of  
FIG. 1;

FIG. 5 is a right side elevational view of the vehicle interior  
light of FIG. 1;

(56) **References Cited**

**U.S. PATENT DOCUMENTS**

D426,329 S *	6/2000	Wang Cheng	.....	D26/28
D435,126 S *	12/2000	Abry	.....	D26/28
D457,981 S *	5/2002	Yeh	.....	D26/76
D467,367 S *	12/2002	Campagna	.....	D26/28

FIG. 6 is a front elevational view of the vehicle interior light  
of FIG. 1;

FIG. 7 is a left side elevational view of the vehicle interior  
light of FIG. 1; and,

FIG. 8 is a rear elevational view of the vehicle interior light  
of FIG. 1.

\* cited by examiner

The broken lines in the drawings form no part of the claimed  
design.

*Primary Examiner*—Marcus A. Jackson

(74) *Attorney, Agent, or Firm*—Christensen O'Connor  
Johnson Kindness PLLC

**1 Claim, 3 Drawing Sheets**

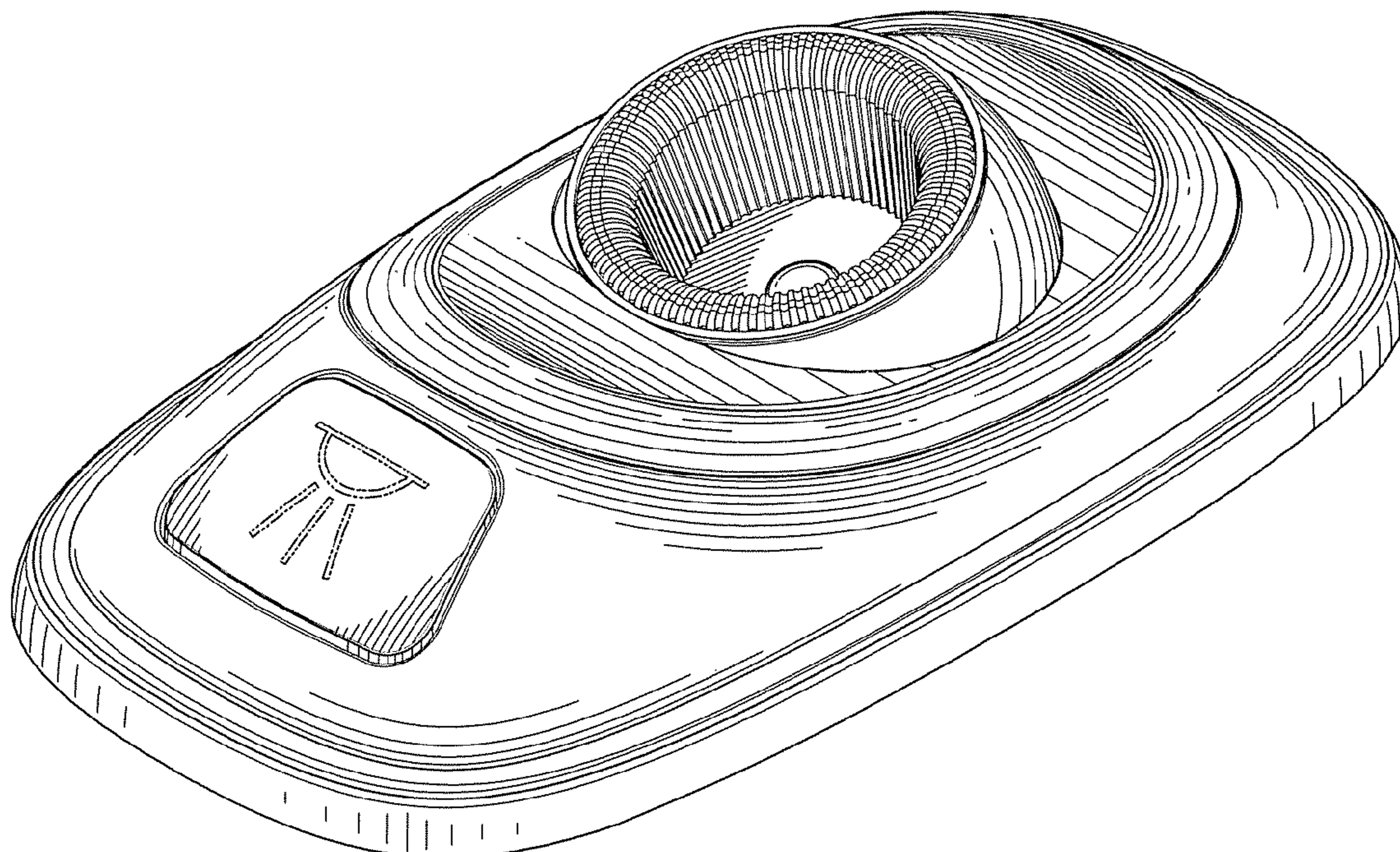

*Fig.1.*

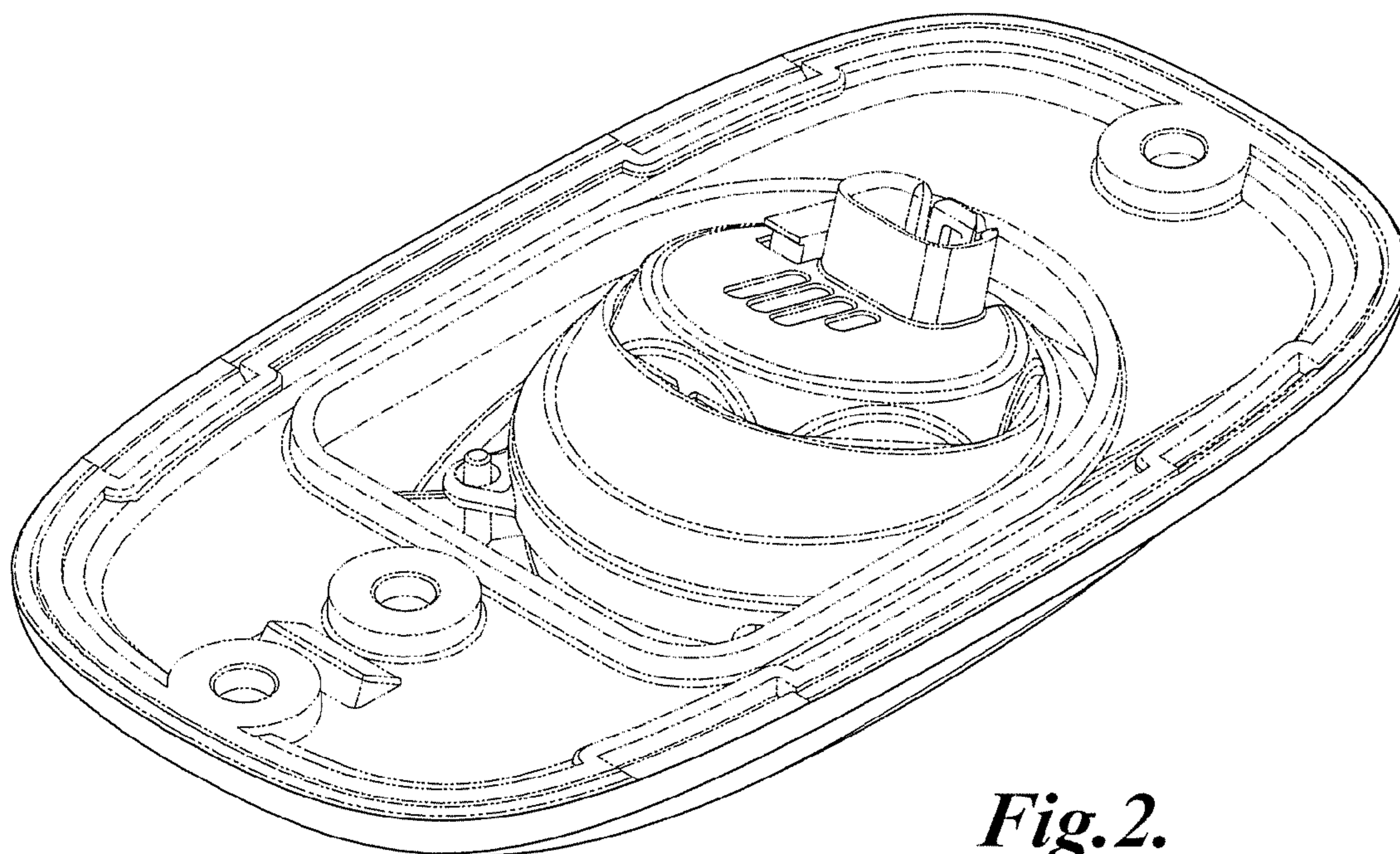
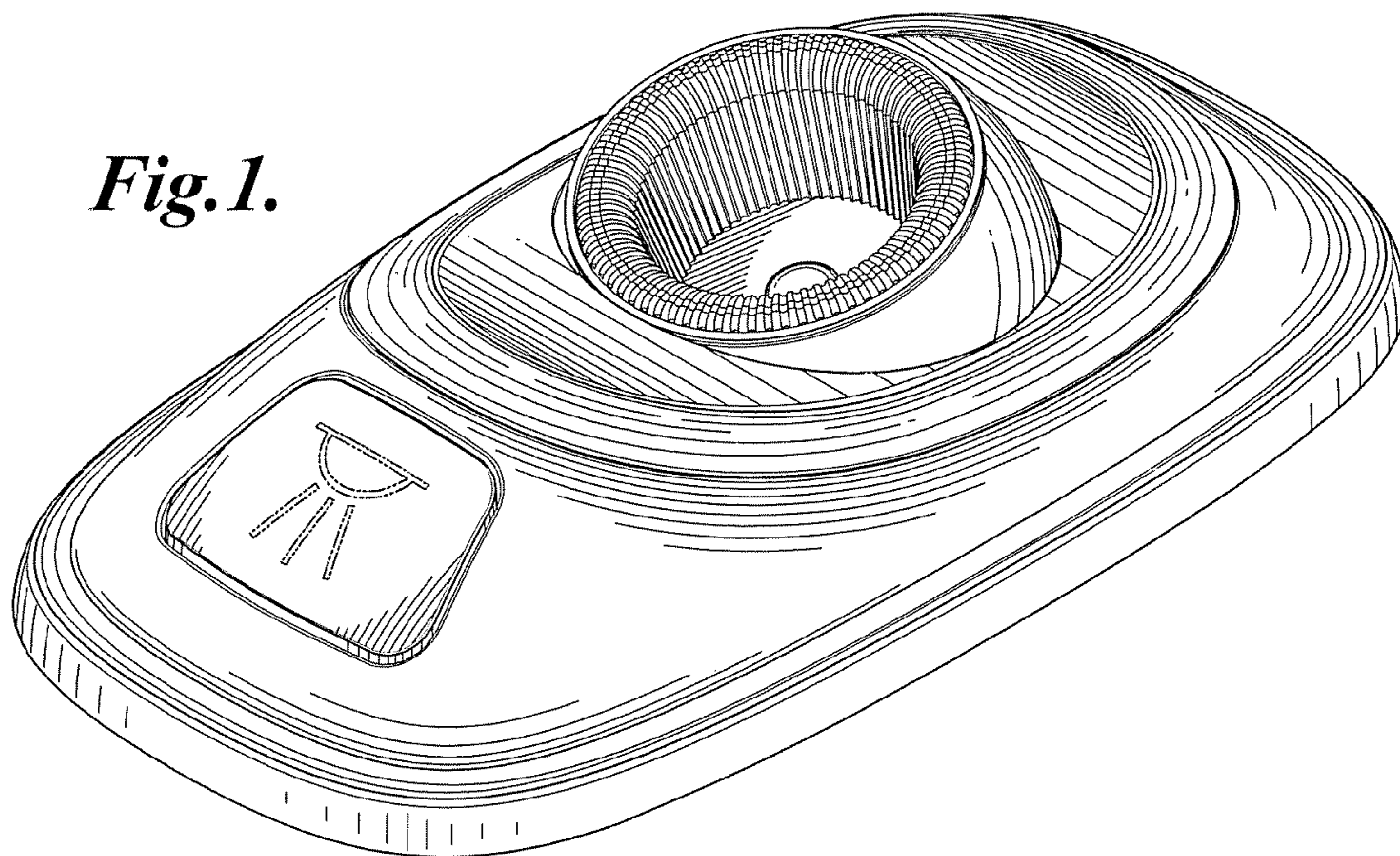

*Fig.2.*

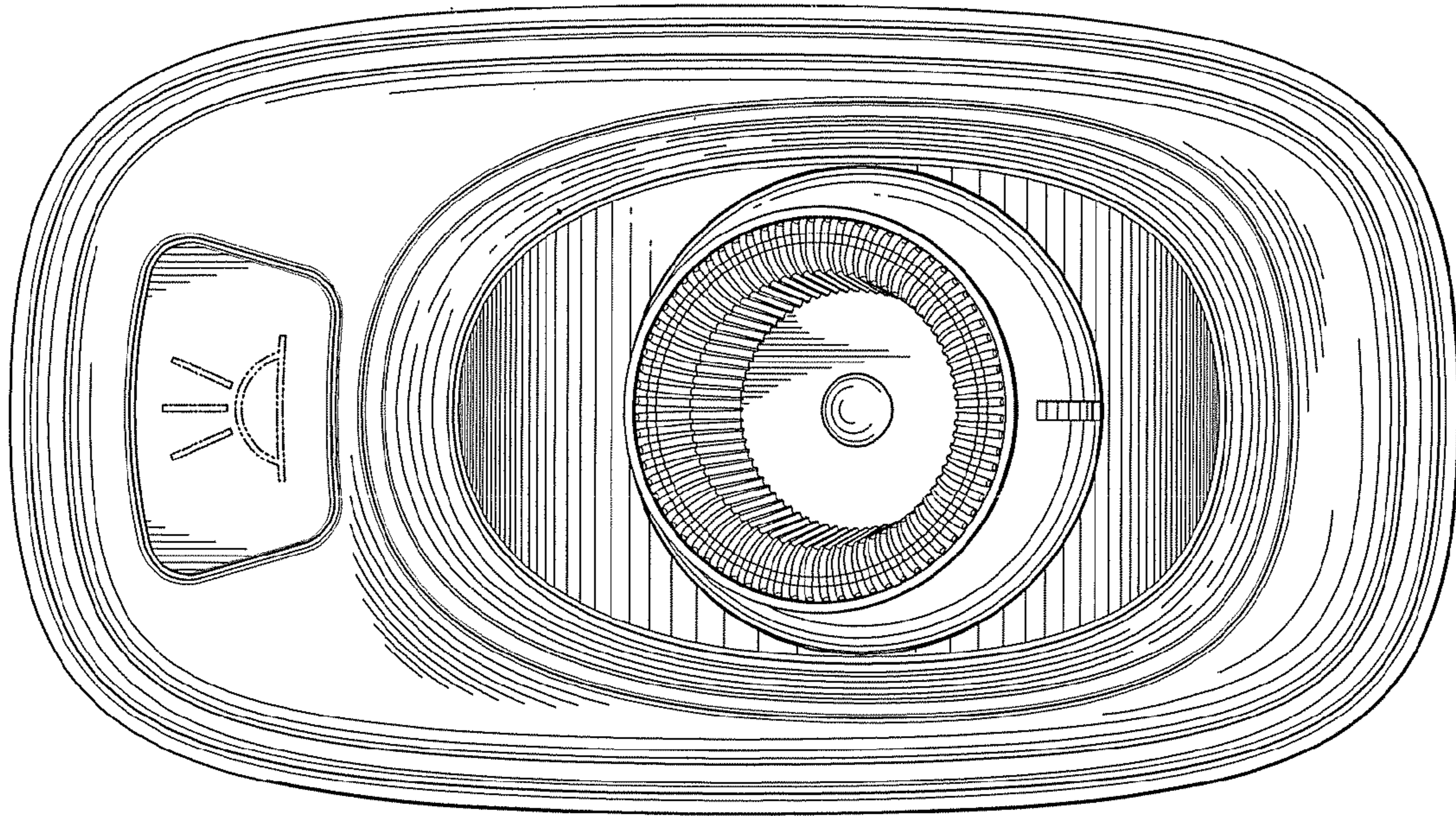

*Fig. 3.*

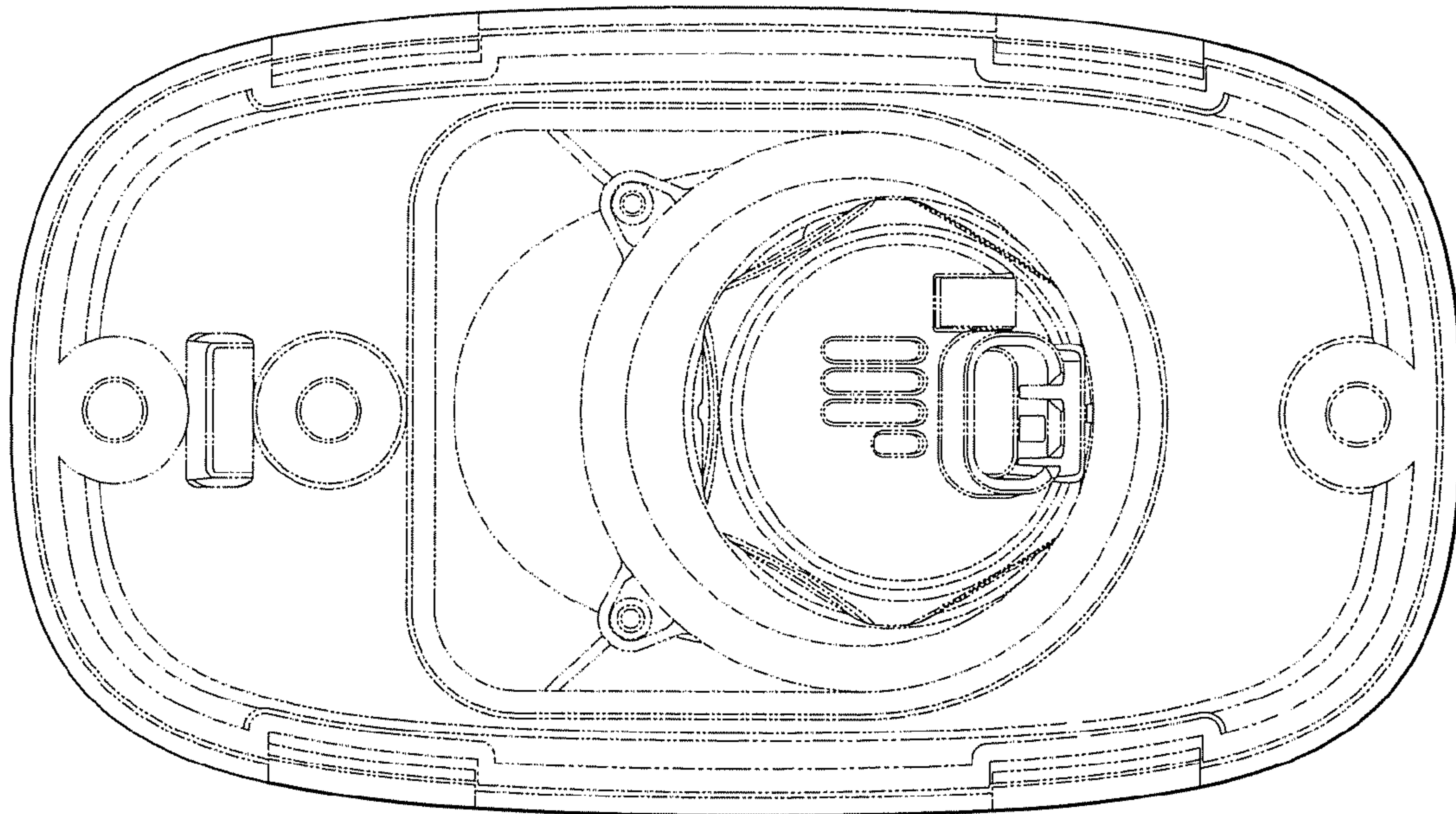

*Fig. 4.*

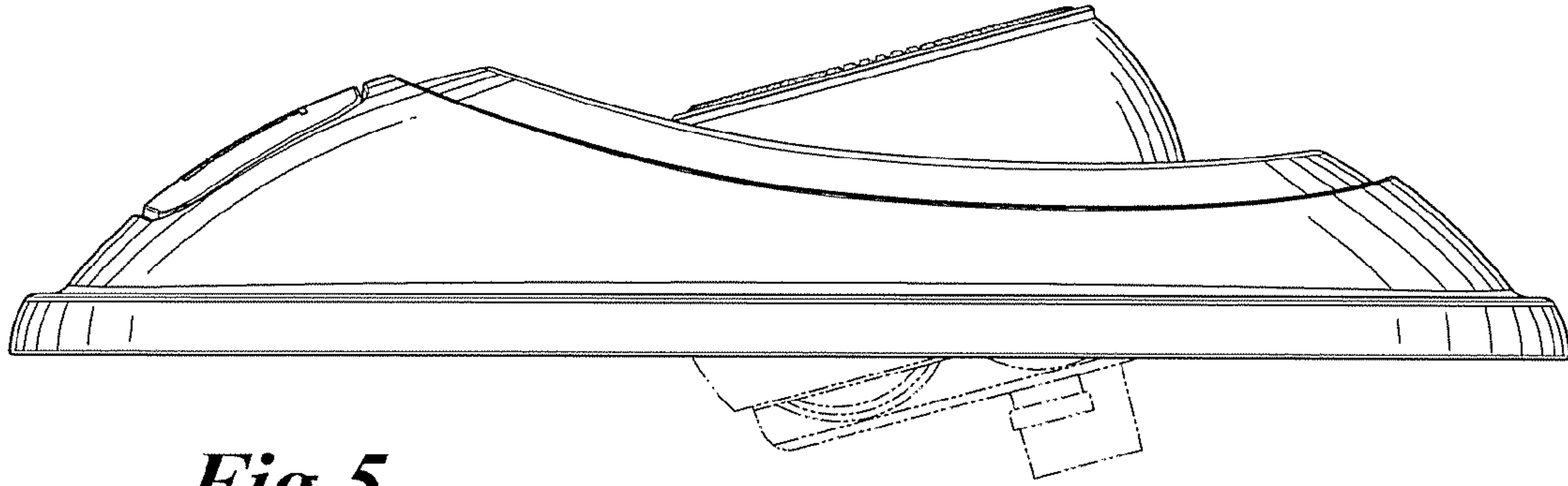

*Fig. 5.*

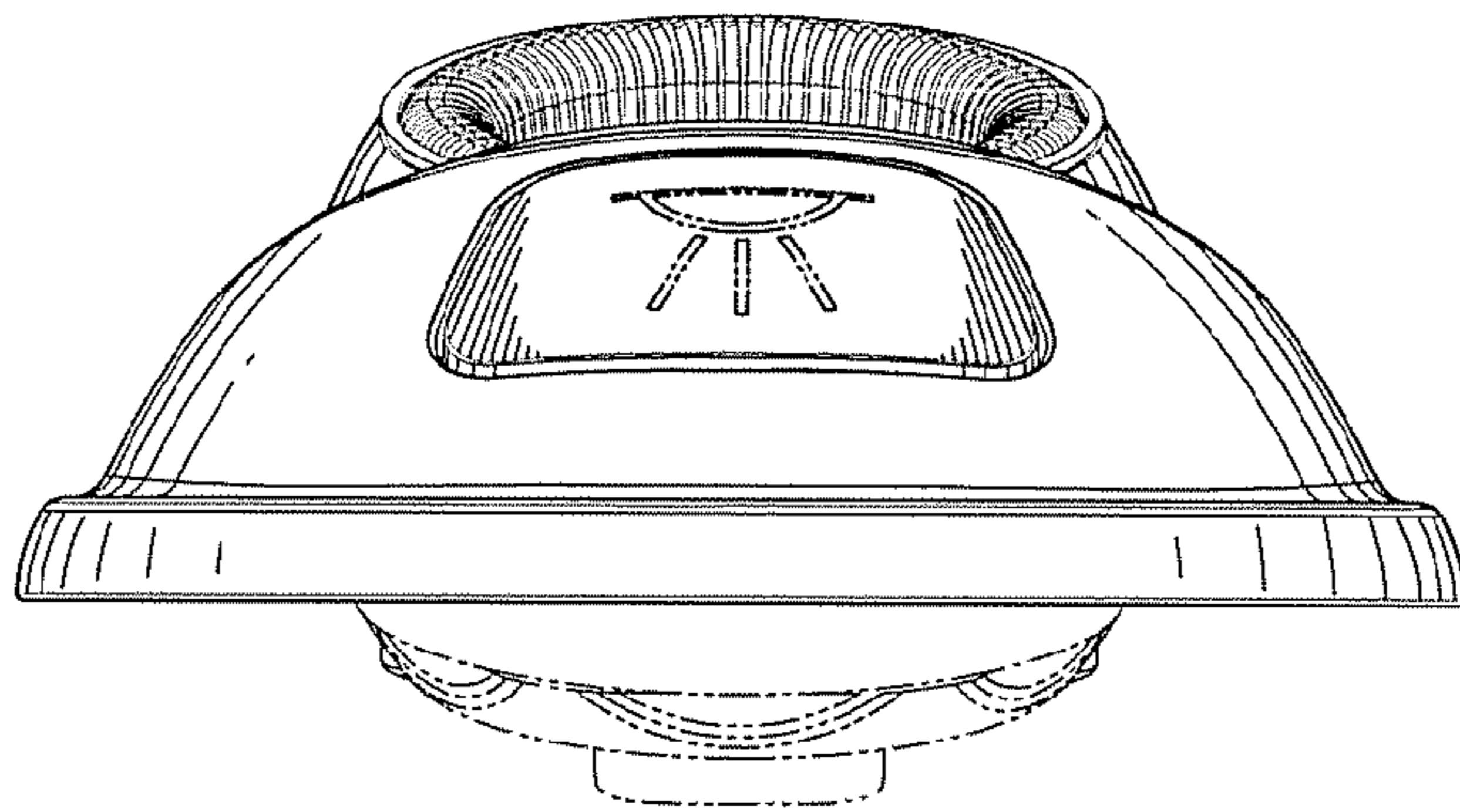

*Fig. 6.*

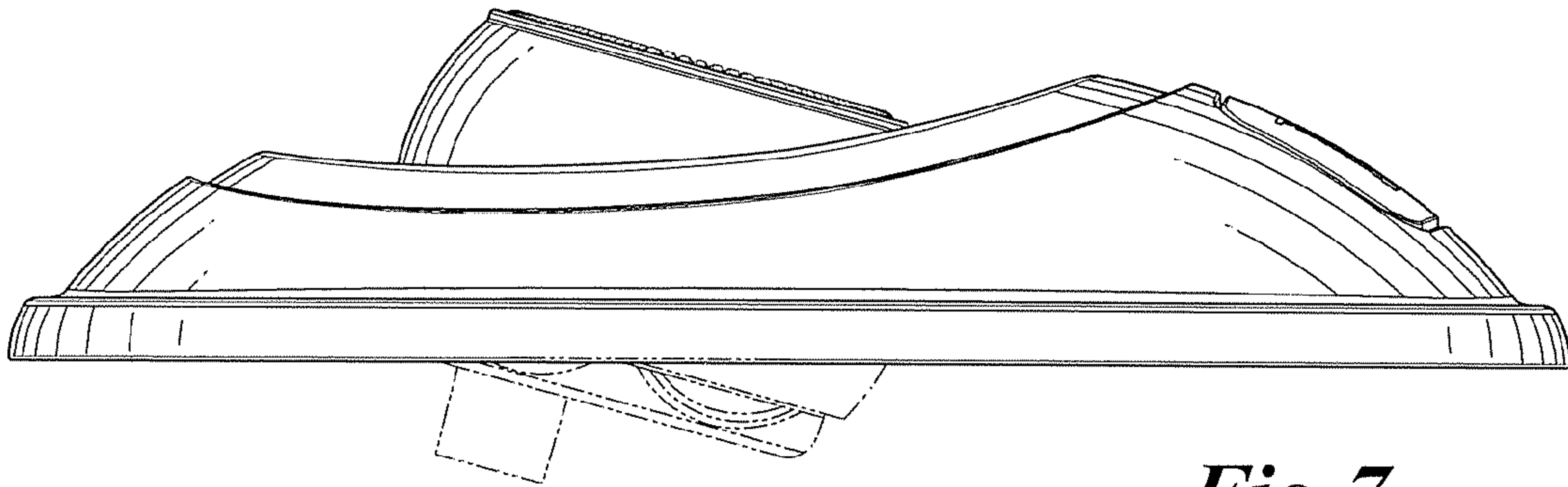

*Fig. 7.*

*Fig. 8.*

