



US00D549205S

(12) **United States Design Patent** (10) **Patent No.:** **US D549,205 S**
Cho (45) **Date of Patent:** **** Aug. 21, 2007**

(54) **MOBILE PHONE**

2005/0090298 A1* 4/2005 Park et al. 455/575.4
2005/0190291 A1* 9/2005 Kota et al. 348/376

(75) Inventor: **Seung Chul Cho**, Seoul (KR)

(Continued)

(73) Assignee: **LG Electronics Inc.**, Seoul (KR)

FOREIGN PATENT DOCUMENTS

(**) Term: **14 Years**

WO DM/067482 * 12/2005

(21) Appl. No.: **29/254,572**

OTHER PUBLICATIONS

(22) Filed: **Feb. 27, 2006**

BenQ-Siemens EL71, announced Feb. 2006, [online], [retrieved on Feb. 16, 2007]. Retrieved from Internet ,<URL: <http://www.gsmarena.com>>.*

(30) **Foreign Application Priority Data**

(Continued)

Aug. 31, 2005 (KR) 30-2005-0029358

(51) **LOC (8) Cl.** **14-03**

Primary Examiner—Jeffrey Asch
Assistant Examiner—Bridget L. Eland

(52) **U.S. Cl.** **D14/138**

(74) *Attorney, Agent, or Firm*—Birch, Stewart, Kolasch & Birch, LLP

(58) **Field of Classification Search** D14/137,
D14/138, 147, 218, 341–347, 496; D21/324,
D21/517; 455/90.3, 556.1, 556.2, 575.1,
455/575.3, 575.4; 379/433.01–433.13; 361/814;
348/14.02

(57) **CLAIM**

See application file for complete search history.

The ornamental design for a mobile phone, as shown and described.

DESCRIPTION

(56) **References Cited**

FIG. 1 is a perspective view of a mobile phone showing my (our) new design;

U.S. PATENT DOCUMENTS

FIG. 2 is a front view thereof;

D466,096 S *	11/2002	Takada	D14/138
D495,695 S *	9/2004	Yugaya	D14/346
D496,645 S *	9/2004	Yoo et al.	D14/138
D511,342 S *	11/2005	Chien	D14/346
D517,038 S *	3/2006	Lee et al.	D14/138
7,050,767 B2 *	5/2006	Hickey et al.	455/90.3
D525,609 S *	7/2006	Kim et al.	D14/138
D526,301 S *	8/2006	Shin	D14/138
D526,302 S *	8/2006	Kim	D14/138
D526,303 S *	8/2006	Kim et al.	D14/138
D527,366 S *	8/2006	Lee	D14/138
D528,094 S *	9/2006	Hwang	D14/138
D528,532 S *	9/2006	Dimitriadis et al.	D14/138
D529,471 S *	10/2006	Park	D14/138
D530,297 S *	10/2006	Moon et al.	D14/138
D534,890 S *	1/2007	Kim	D14/138
D536,691 S *	2/2007	Park	D14/138

FIG. 7 is a bottom plan view thereof;

FIG. 8 is a front view thereof in a condition that the upper body thereof is slided upward and the inner key pad is exposed; and,

FIG. 9 is a front view thereof in a condition that the upper body thereof is slided rightward and the inner key pad is exposed.

1 Claim, 8 Drawing Sheets

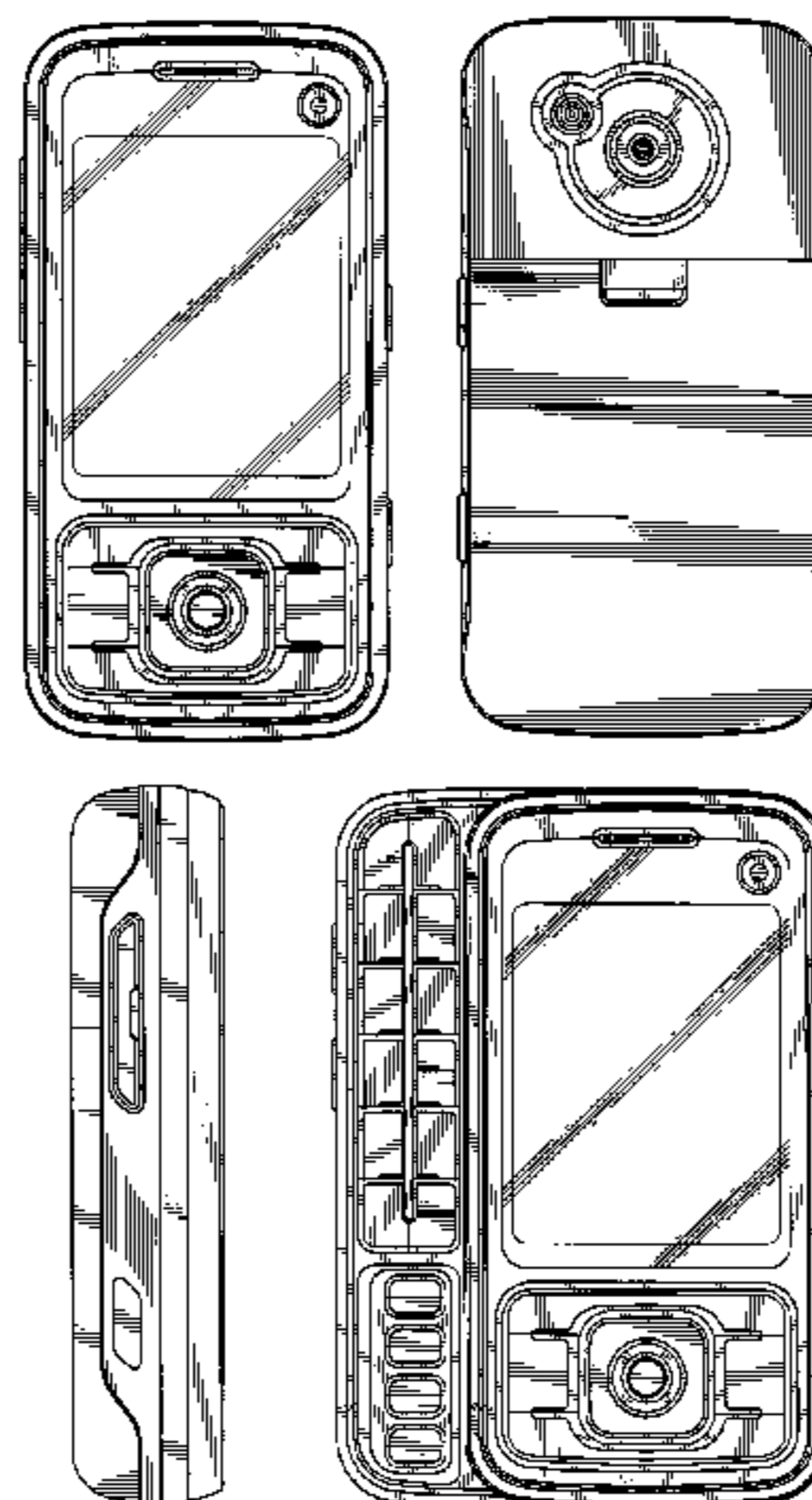

U.S. PATENT DOCUMENTS

2005/0255897	A1*	11/2005	Lee et al.	455/575.4
2006/0009255	A1*	1/2006	Vuolteenaho	455/556.1
2006/0025184	A1*	2/2006	Cho et al.	455/575.4
2006/0046796	A1*	3/2006	Park et al.	455/575.4
2006/0094464	A1*	5/2006	Kyou et al.	455/556.1
2006/0205450	A1*	9/2006	Amano et al.	455/575.4
2007/0032278	A1*	2/2007	Lee et al.	455/575.4

OTHER PUBLICATIONS

Toshiba G900, announced Feb. 2007, [online], [retrieved on Feb. 20, 2007]. Retrieved from Internet ,<URL: <http://www.gsmarena.com>>.*

Nokia E65, announced Feb. 2007, [online], [retrieved on Feb. 16, 2007]. Retrieved from Internet ,<URL: <http://www.gsmarena.com>>.*

Nokia N95, announced Sep. 2006, [online], [retrieved on Feb. 16, 2007]. Retrieved from Internet ,<URL: <http://www.gsmarena.com>>.*

LG KS10, announced Feb. 2007, [online], [retrieved on Feb. 20, 2007]. Retrieved from Internet ,<URL: <http://www.gsmarena.com>>.*

HTC P3600, announced Sep. 2006, [online], [retrieved on Feb. 20, 2007]. Retrieved from Internet ,<URL: <http://www.gsmarena.com>>.*

LG M6100, announced Jan. 2006, [online], [retrieved on Feb. 20, 2007]. Retrieved from Internet ,<URL: <http://www.gsmarena.com>>.*

Siemens CF110, announced Aug. 2005, [online], [retrieved on Feb. 20, 2007]. Retrieved from Internet ,<URL: <http://www.gsmarena.com>>.*

* cited by examiner

FIG. 1

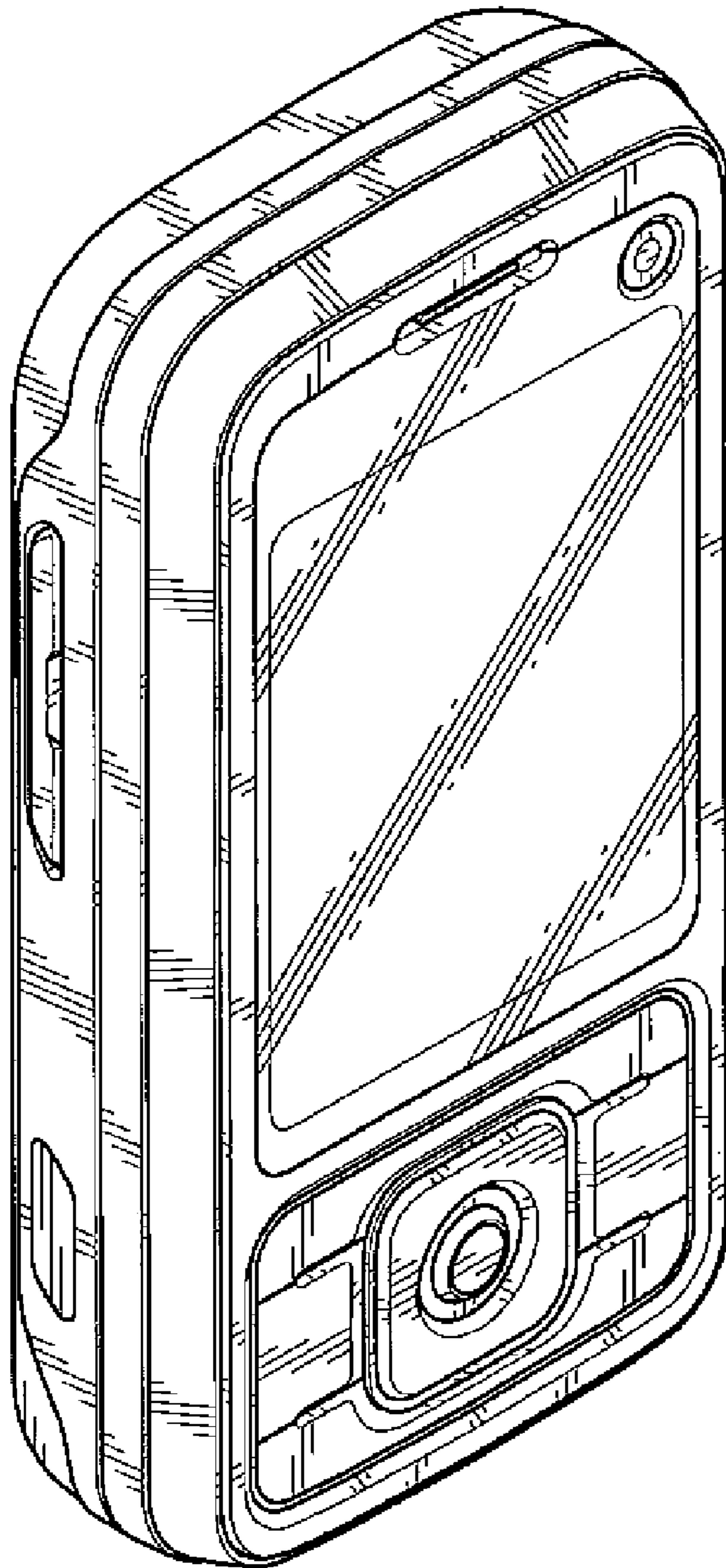

FIG. 2

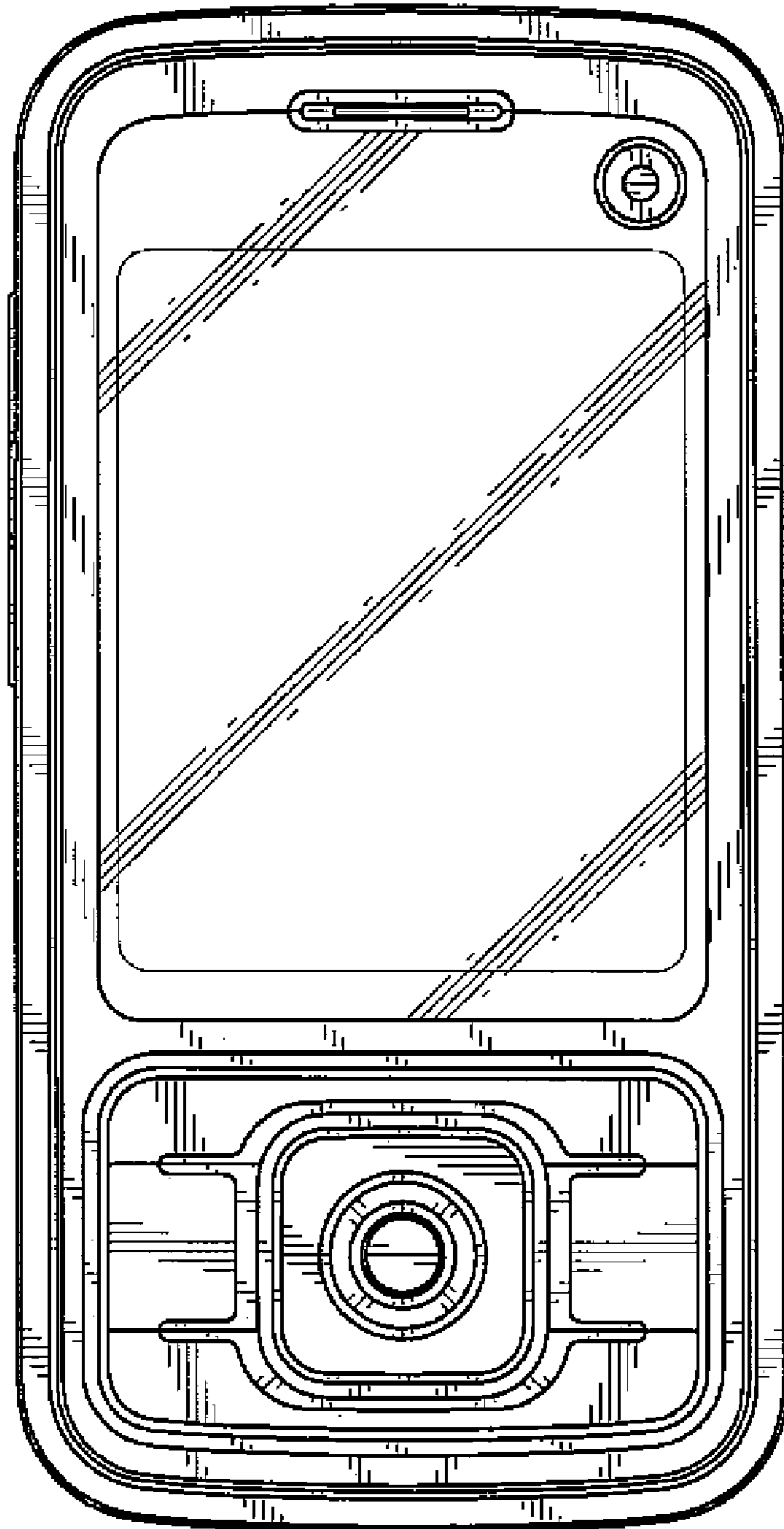

FIG. 3

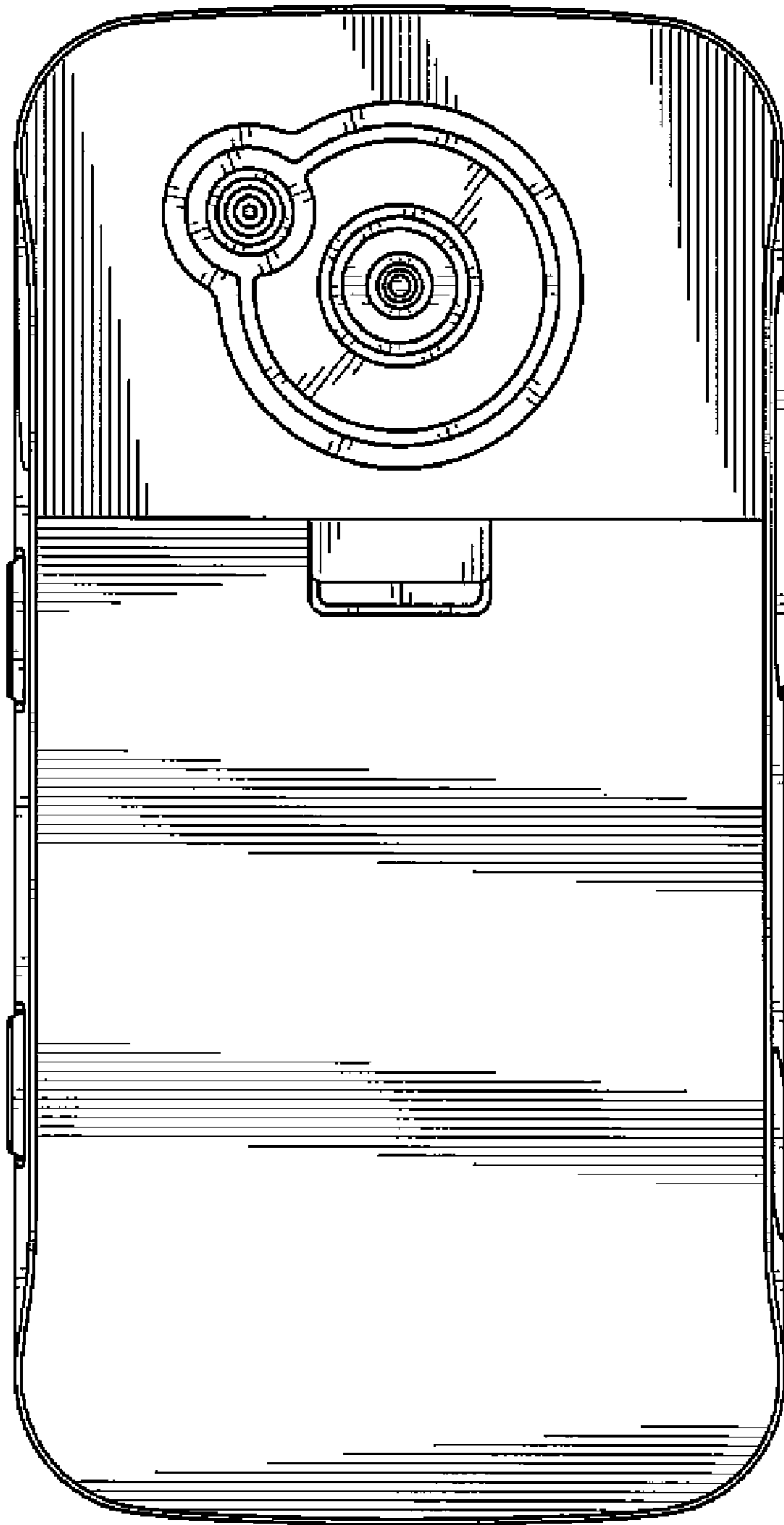

FIG. 4

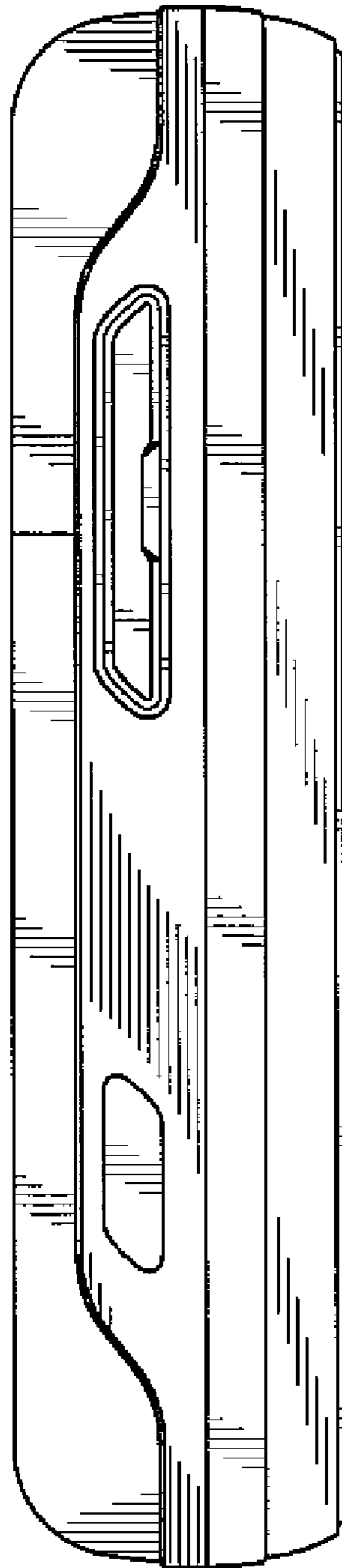

FIG. 5

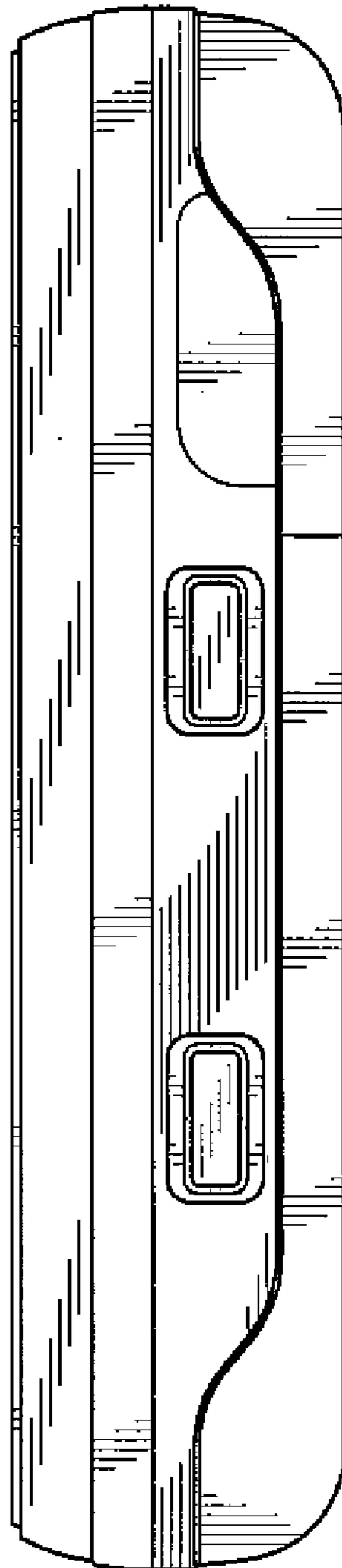

FIG. 6

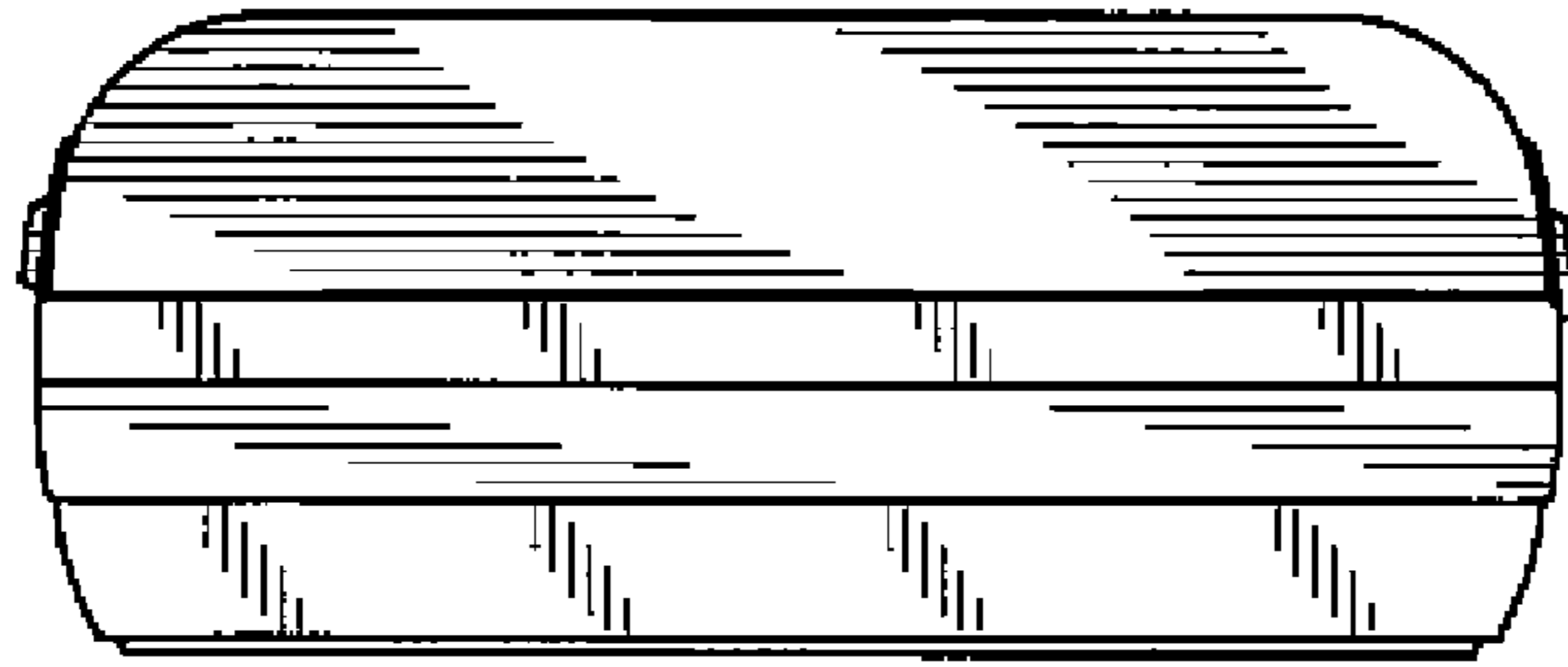

FIG. 7

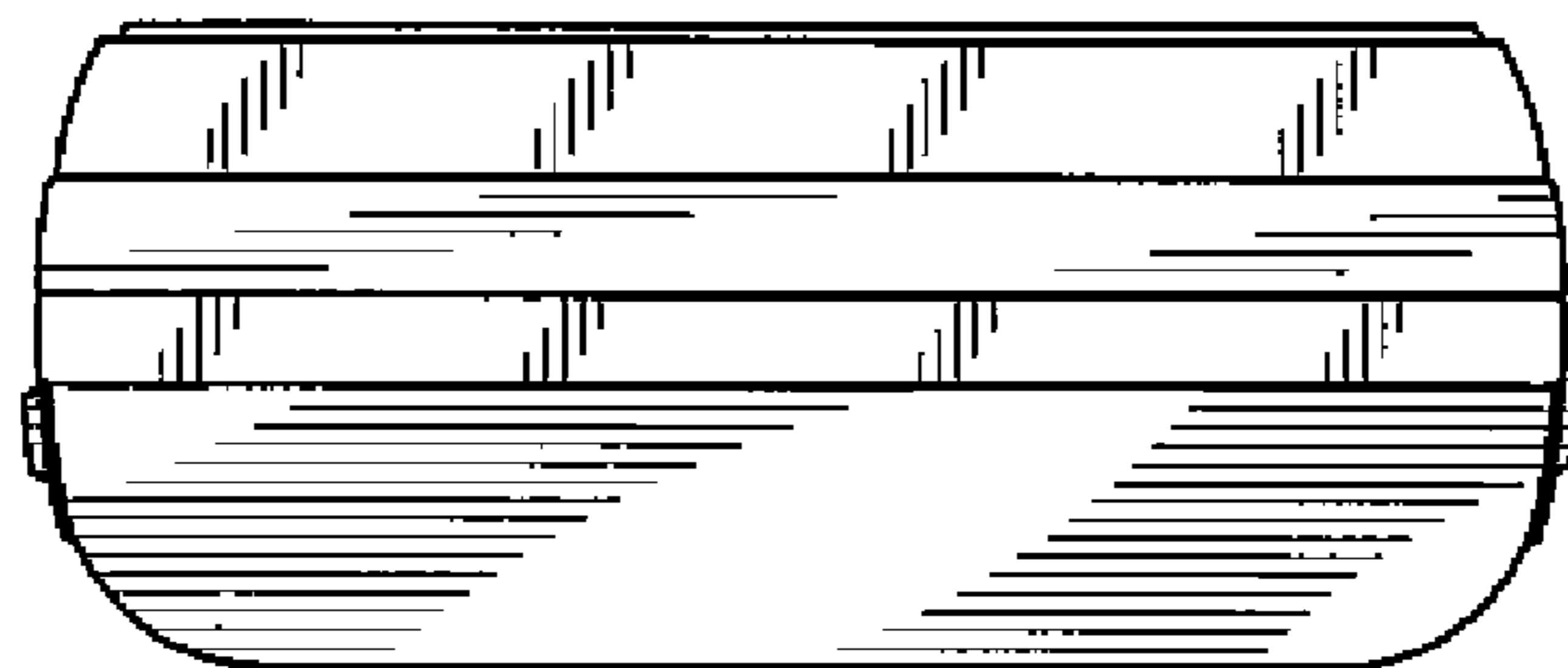

FIG. 8

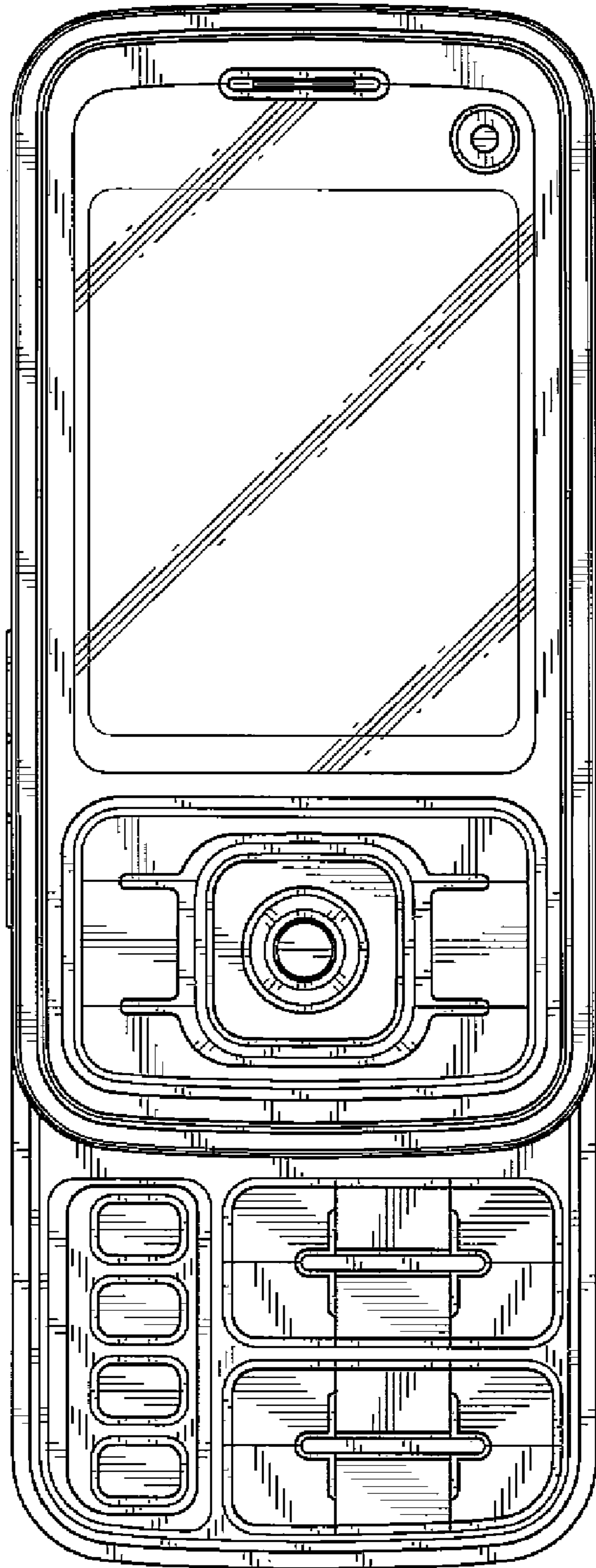

FIG. 9

