



US00D549186S

(12) **United States Design Patent** (10) **Patent No.:** **US D549,186 S**  
**Yuzawa** (45) **Date of Patent:** **\*\* Aug. 21, 2007**

(54) **CONDENSER LENS FOR A LIGHT EMITTING DIODE**

2006/0284305 A1\* 12/2006 Yen et al. .... 257/708  
2006/0291203 A1\* 12/2006 Anandan ..... 362/231

(75) Inventor: **Osamu Yuzawa**, Saitama (JP)

\* cited by examiner

(73) Assignee: **Moritex Corporation**, Tokyo (JP)

*Primary Examiner*—Selina Sikder

(\*\*) Term: **14 Years**

(74) *Attorney, Agent, or Firm*—Greenblum & Bernstein, P.L.C.

(21) Appl. No.: **29/260,895**

(57) **CLAIM**

(22) Filed: **Jun. 5, 2006**

I claim the ornamental design for a condenser lens for a light emitting diode, as shown and described.

(30) **Foreign Application Priority Data**

**DESCRIPTION**

Dec. 5, 2005 (JP) ..... 2005-035780

(51) **LOC (8) Cl.** ..... **13-03**

(52) **U.S. Cl.** ..... **D13/180**

(58) **Field of Classification Search** ..... D13/180;  
D26/2; 257/79, 80, 81, 82, 88, 89, 95, 98,  
257/99, 100, 678, 680, 433, 434; 313/483,  
313/498, 500; 361/820; 362/555, 800

See application file for complete search history.

FIG. 1 is a front view of a condenser lens for a light emitting diode, showing my new design;

FIG. 2 is a rear view of a condenser lens for a light emitting diode, showing my new design;

FIG. 3 is a right side view of a condenser lens for a light emitting diode, showing my new design, the left side view being a mirror image;

FIG. 4 is a top plan view of a condenser lens for a light emitting diode, showing my new design, the bottom plan view being a mirror image;

FIG. 5 is a cross sectional view, taken along a center line 5—5 of FIG. 1, of a condenser lens for a light emitting diode, showing my new design;

FIG. 6 is a front perspective view of a condenser lens for a light emitting diode, showing my new design;

FIG. 7 is a rear perspective view of a condenser lens for a light emitting diode, showing my new design; and,

FIG. 8 is a reference cross sectional view of a condenser lens for a light emitting diode, showing my new design, and including a light emitting diode shown in broken lines forming no part of the claimed design.

(56) **References Cited**

**U.S. PATENT DOCUMENTS**

- 6,371,637 B1\* 4/2002 Atchinson et al. .... 362/555
- 6,828,590 B2\* 12/2004 Hsiung ..... 257/79
- D523,826 S\* 6/2006 Kamada ..... D13/180
- D524,260 S\* 7/2006 Ishizaka et al. .... D13/180
- 7,081,644 B2\* 7/2006 Flaherty et al. .... 257/98
- D532,383 S\* 11/2006 Nagai et al. .... D13/180
- 7,153,000 B2\* 12/2006 Park et al. .... 362/268
- 2003/0020077 A1\* 1/2003 Horiuchi et al. .... 257/81
- 2004/0041222 A1\* 3/2004 Loh ..... 257/433
- 2004/0126913 A1\* 7/2004 Loh ..... 438/26
- 2005/0269587 A1\* 12/2005 Loh et al. .... 257/99
- 2006/0157726 A1\* 7/2006 Loh et al. .... 257/100
- 2006/0220049 A1\* 10/2006 Flaherty et al. .... 257/98
- 2006/0284209 A1\* 12/2006 Kim et al. .... 257/100

**1 Claim, 4 Drawing Sheets**

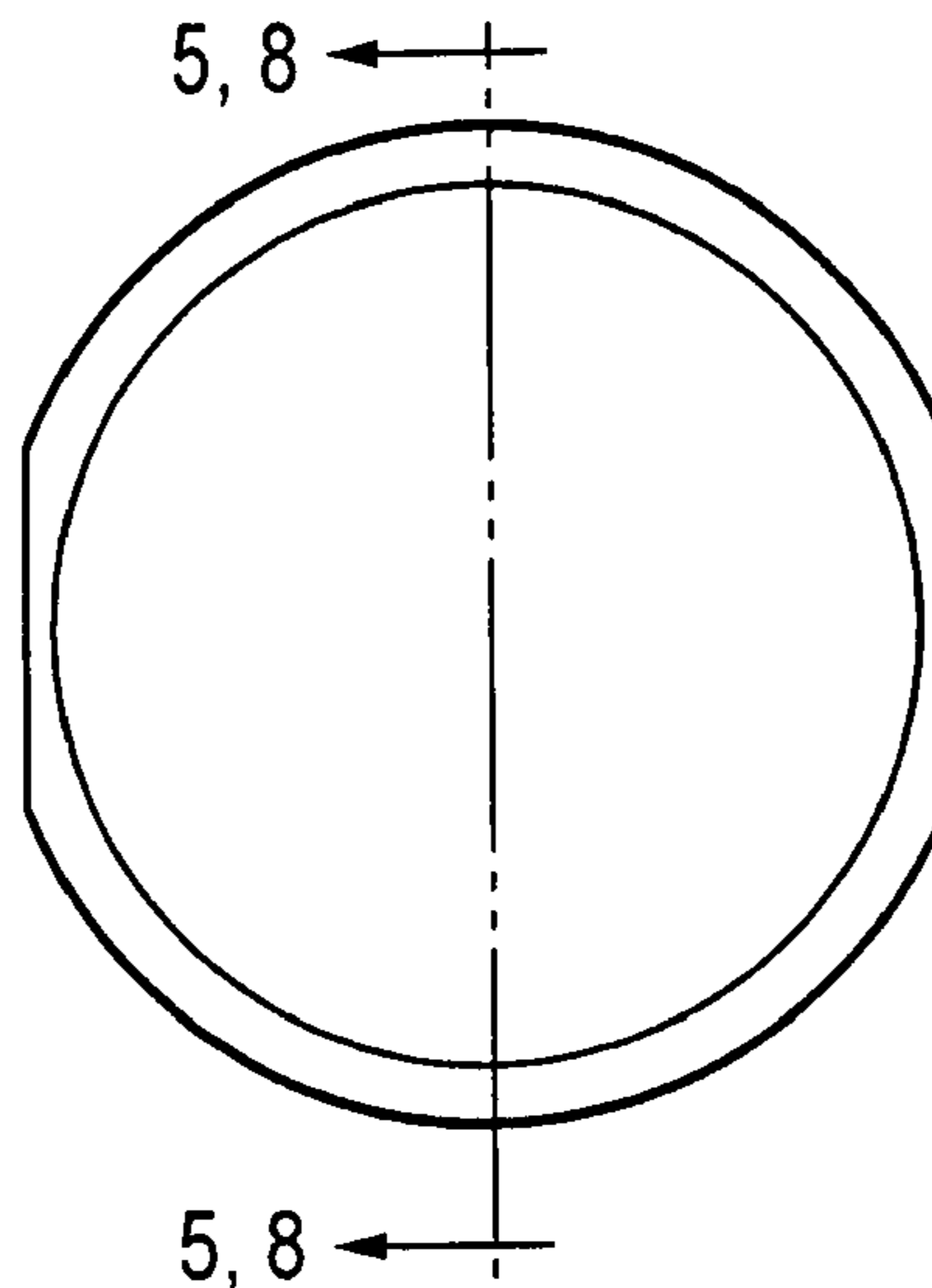

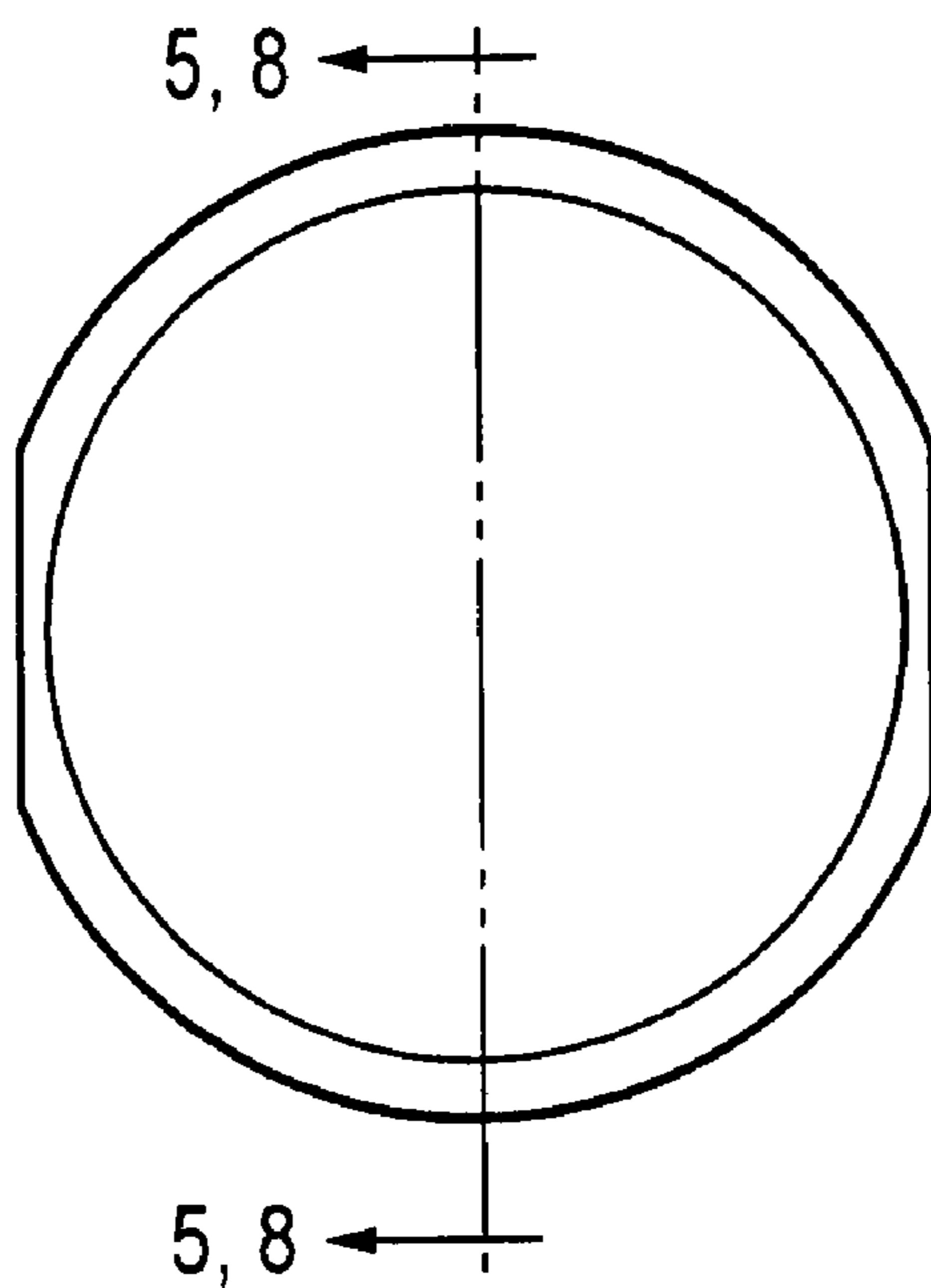

FIG. 1

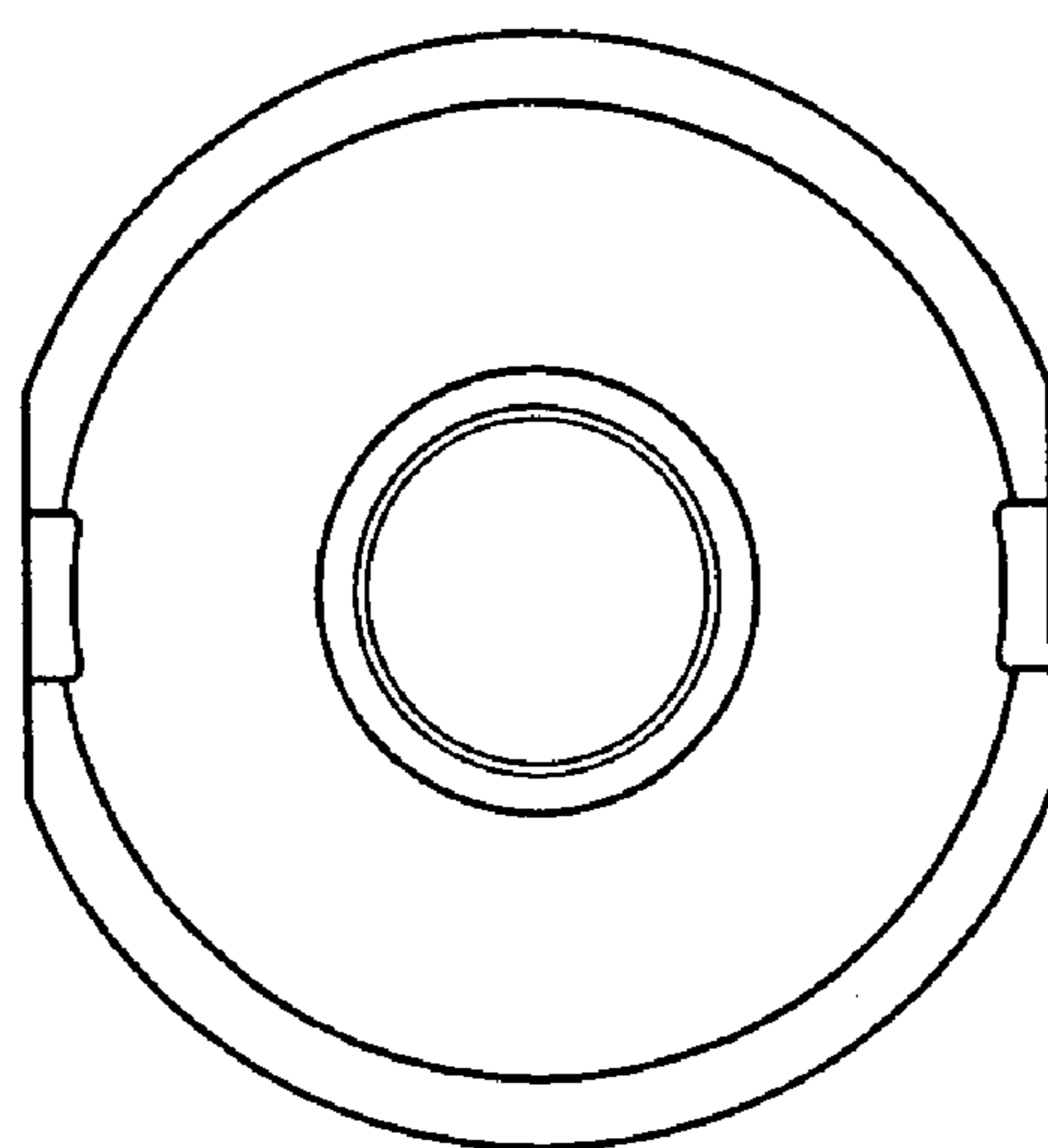

FIG. 2

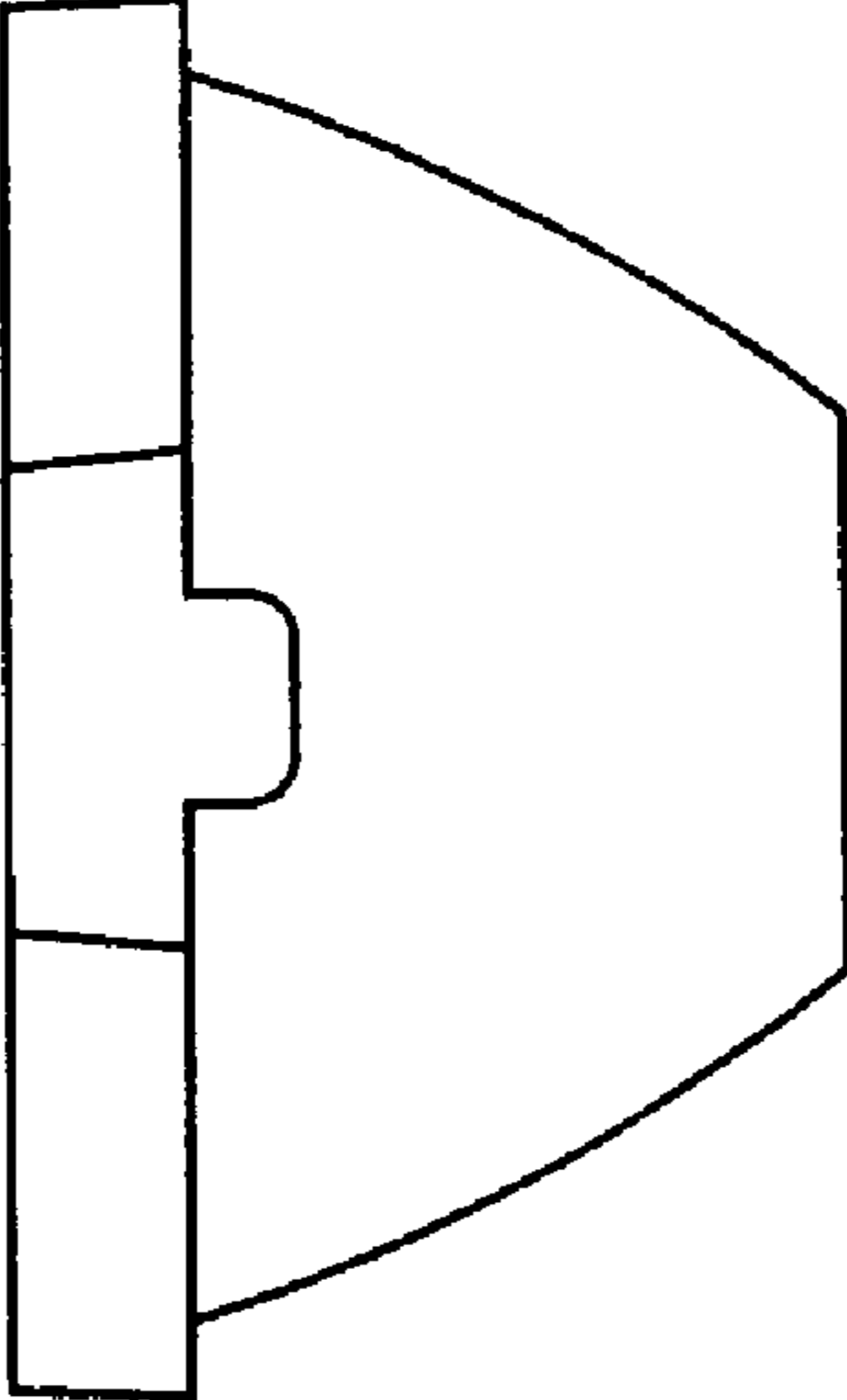

FIG. 3

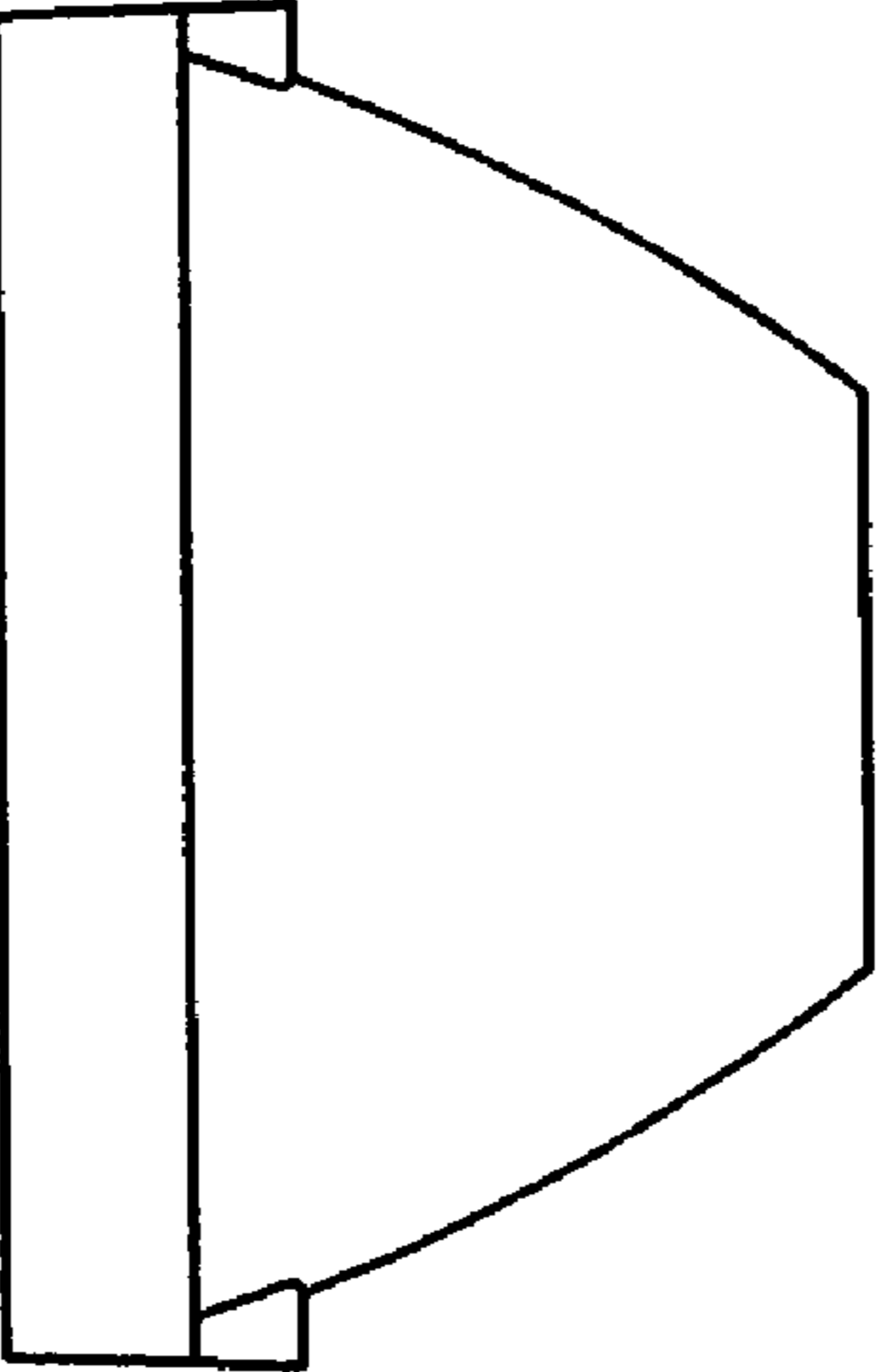

FIG. 4

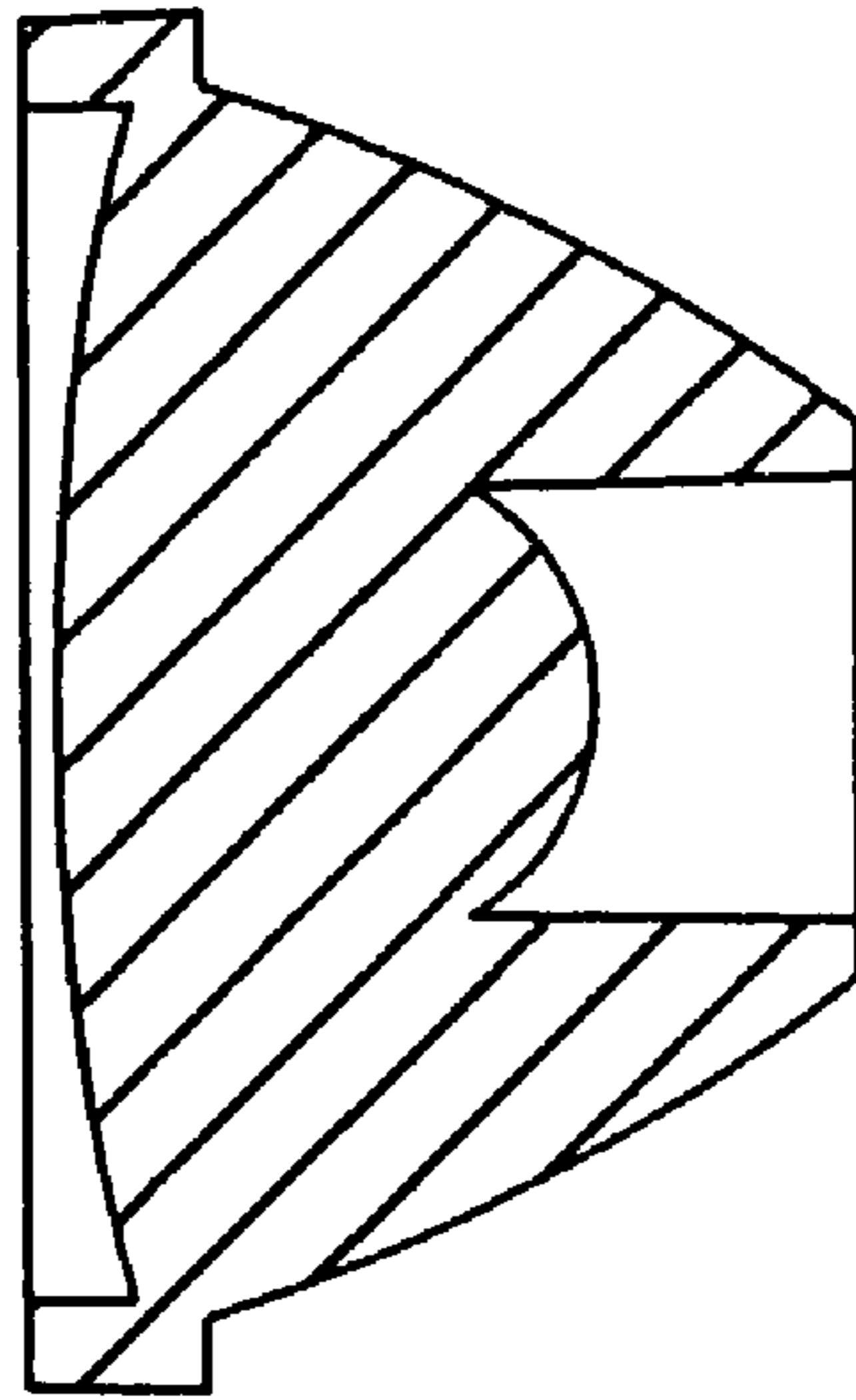

FIG. 5

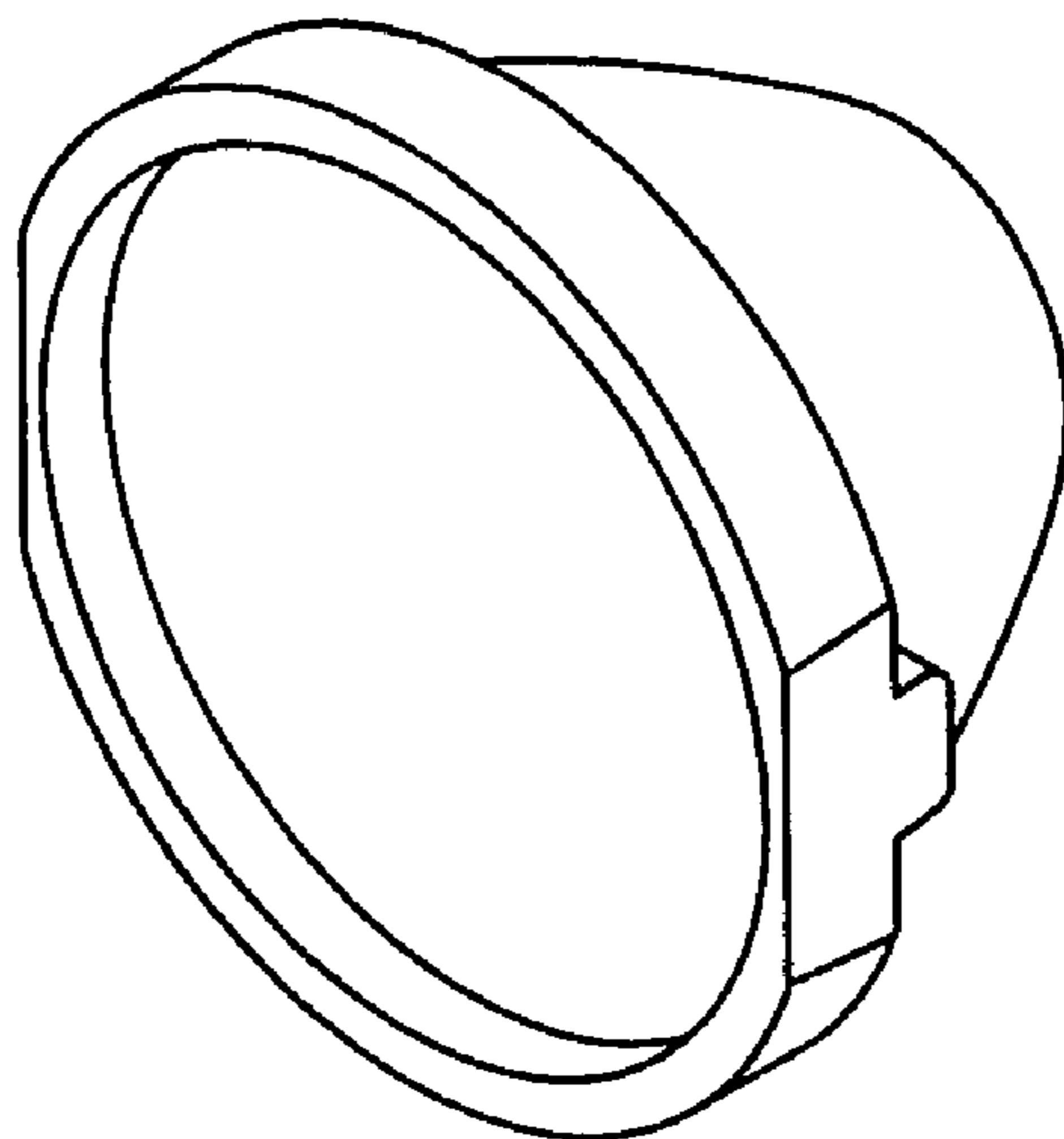

FIG. 6

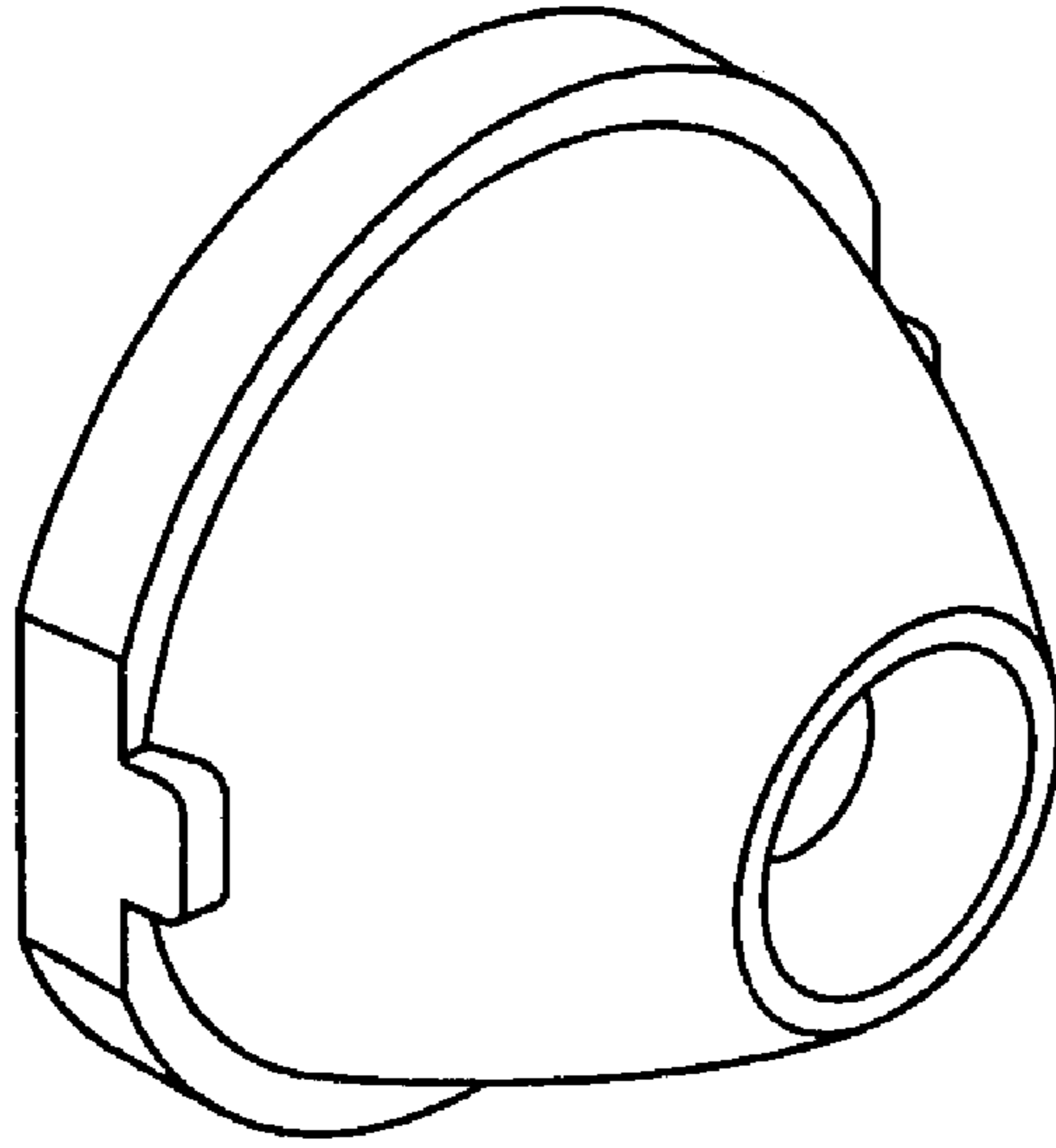

FIG. 7

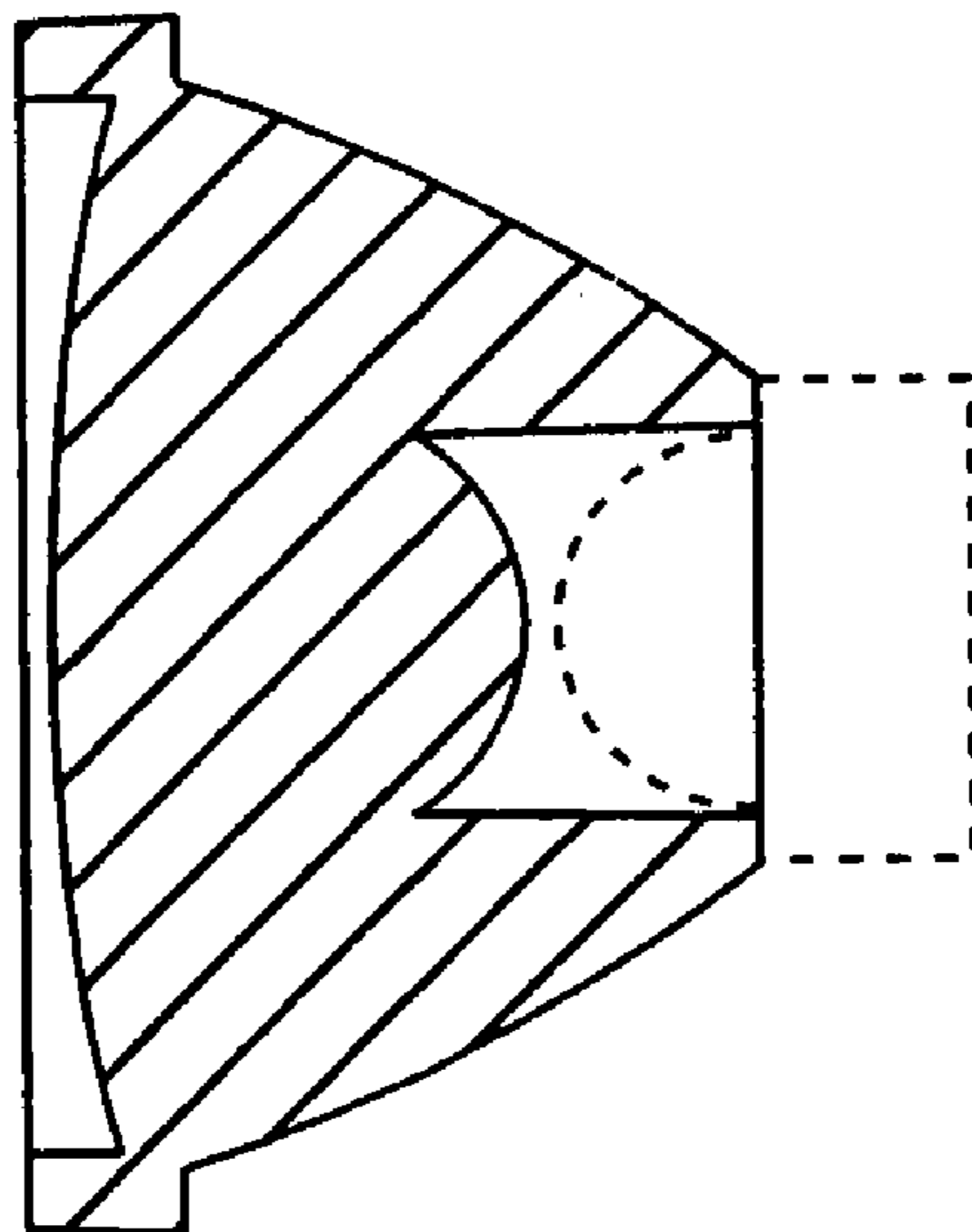

FIG. 8