

US00D549083S

(12) **United States Design Patent**
Barnett et al.

(10) **Patent No.:** **US D549,083 S**

(45) **Date of Patent:** **** Aug. 21, 2007**

(54) **WREATH HANGER**

(76) Inventors: **David S. Barnett**, 5226 E. Helena Dr.,
Scottsdale, AZ (US) 85254; **Diane L. Barnett**, 5226 E. Helena Dr.,
Scottsdale, AZ (US) 85254

(**) Term: **14 Years**

(21) Appl. No.: **29/254,408**

(22) Filed: **Feb. 23, 2006**

(51) **LOC (8) Cl.** **08-05**

(52) **U.S. Cl.** **D8/373**

(58) **Field of Classification Search** D8/373,
D8/367; 211/13.1; 248/301.304, 307, 215
See application file for complete search history.

(56) **References Cited**

U.S. PATENT DOCUMENTS

D353,992 S *	1/1995	Dombrowski	D8/373
D365,015 S	12/1995	Avinger		
D374,168 S *	10/1996	Protz, Jr.	D8/373
D407,567 S	4/1999	Barnett et al.		
D445,669 S	7/2001	Goodman et al.		

6,311,851 B1 *	11/2001	Knudsen	211/13.1
6,575,416 B1 *	6/2003	Avinger	248/307
6,857,608 B2 *	2/2005	Avinger	248/215

* cited by examiner

Primary Examiner—Holly H. Baynham
(74) *Attorney, Agent, or Firm*—Wright Law Group, PLLC;
Mark F. Wright

(57) **CLAIM**

The ornamental design for a wreath hanger, as shown and described.

DESCRIPTION

FIG. 1 is a perspective view of a wreath hanger showing the new design;

FIG. 2 is a front view thereof;

FIG. 3 is a back view thereof;

FIG. 4 is a left side view thereof;

FIG. 5 is a bottom view thereof; and,

FIG. 6 is a top view thereof.

1 Claim, 3 Drawing Sheets

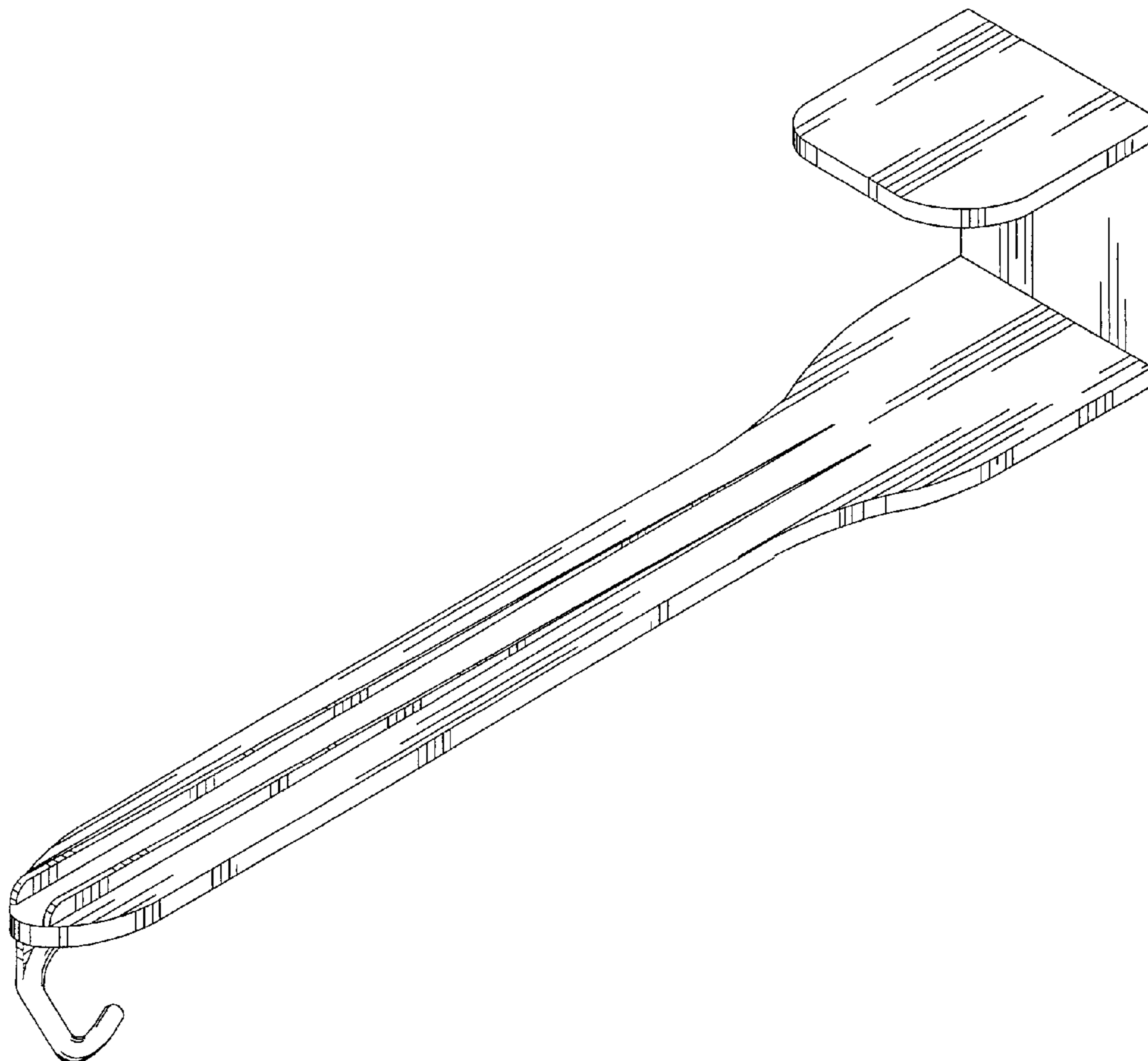

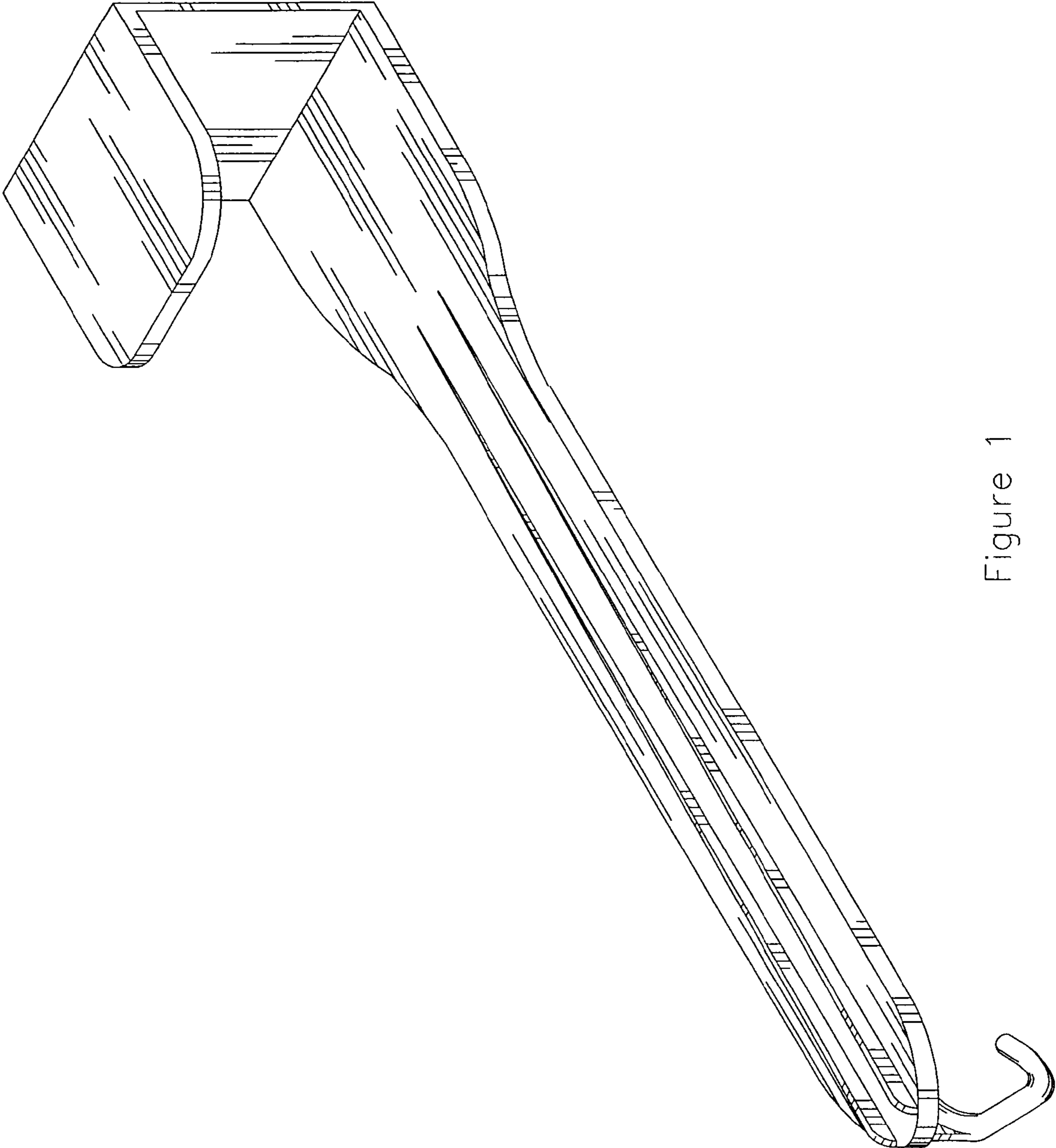

Figure 1

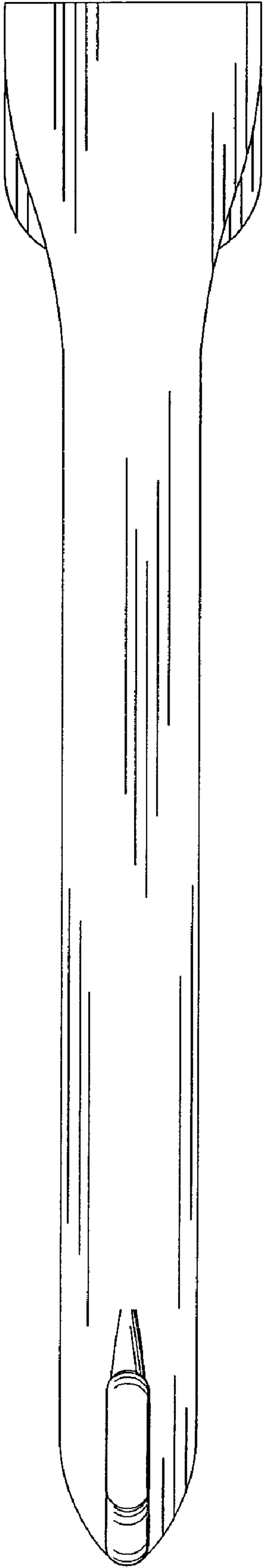

Figure 2

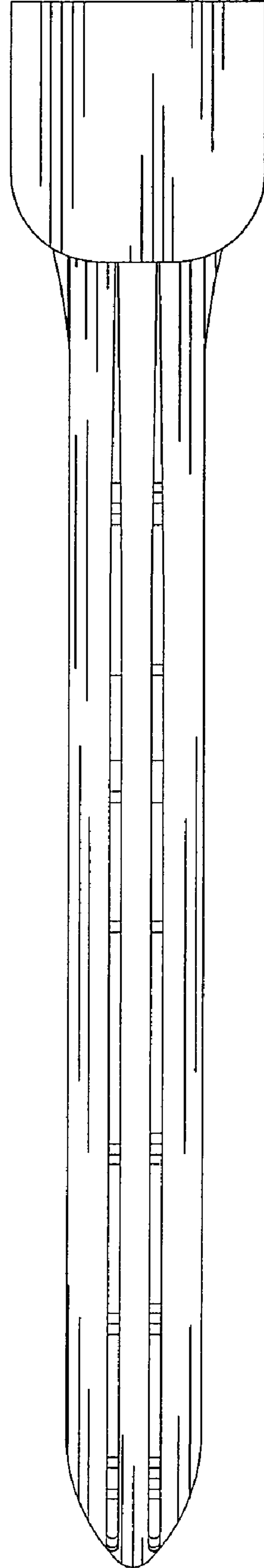

Figure 3

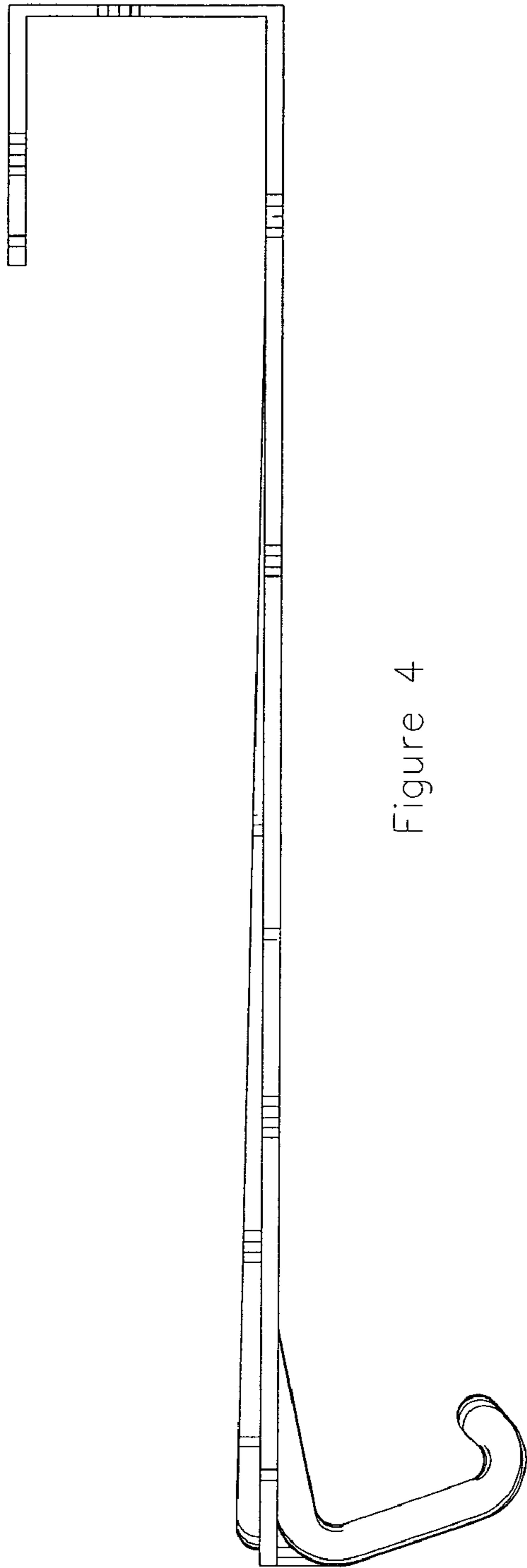

Figure 4

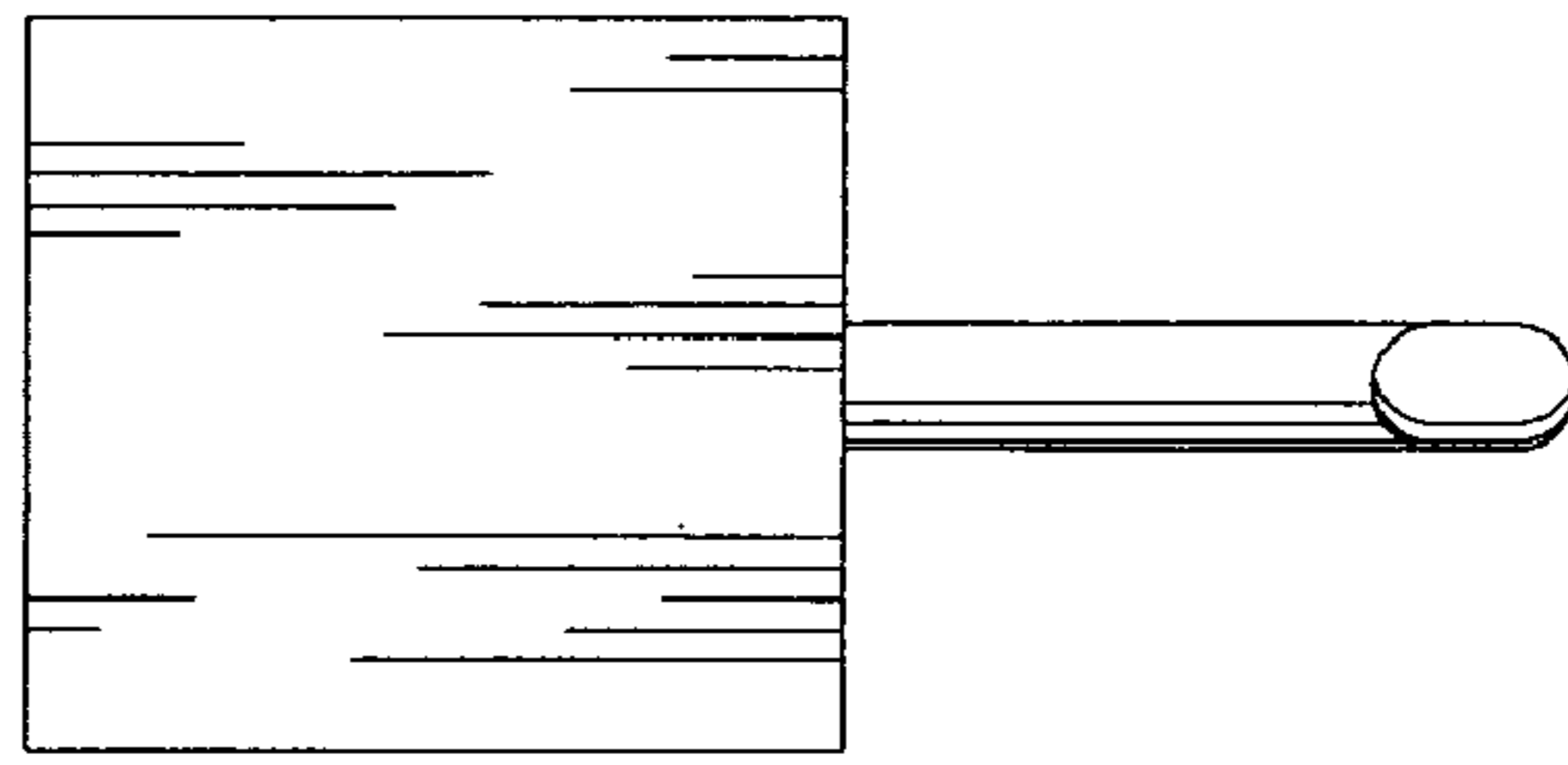

Figure 6

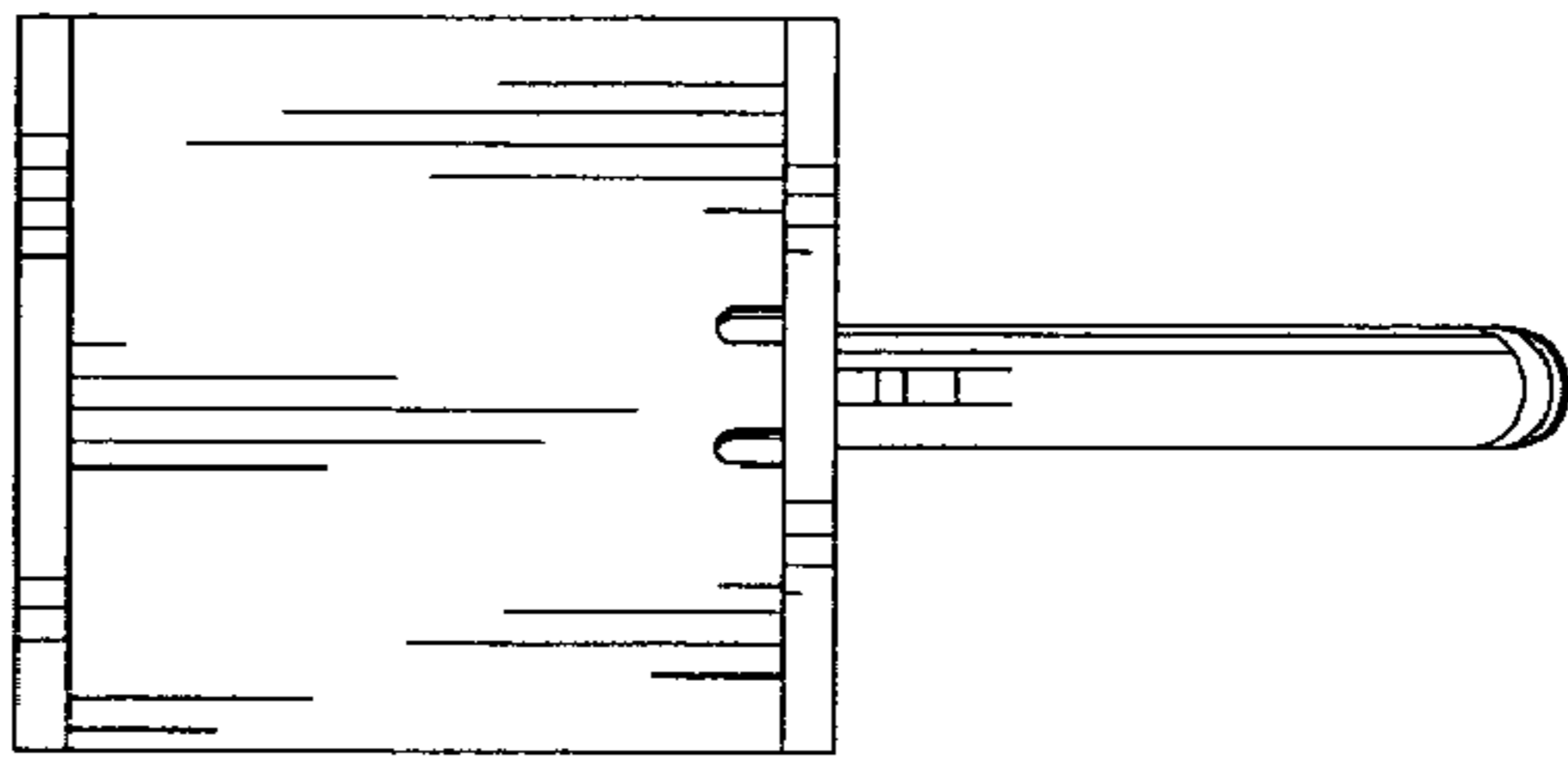

Figure 5