



US00D549048S

(12) **United States Design Patent**
Duke et al.

(10) **Patent No.: US D549,048 S**

(45) **Date of Patent: ** Aug. 21, 2007**

(54) **SPORTS BOTTLE**

(75) Inventors: **James Duke**, Houston, TX (US); **Taka Okai**, Round Rock, TX (US)

(73) Assignee: **Igloo Products Corp.**, Katy, TX (US)

(**) Term: **14 Years**

(21) Appl. No.: **29/231,322**

(22) Filed: **Jun. 2, 2005**

(51) **LOC (8) Cl.** **07-01**

(52) **U.S. Cl.** **D7/510; D7/511**

(58) **Field of Classification Search** D9/571,
D9/560, 502-504, 523, 525, 556, 557, 565,
D9/446, 447; D7/510, 511, 509, 900, 605,
D7/612; 220/254.3, 792; 215/388; 222/153.06,
222/153.07, 211

See application file for complete search history.

(56) **References Cited**

U.S. PATENT DOCUMENTS

D97,212 S *	10/1935	Stuernagle	D9/552
2,754,866 A *	7/1956	Coltman, Jr.	220/254.3
D286,616 S *	11/1986	Becker	D9/571
D315,409 S *	3/1991	Baarber	D24/197
D324,822 S *	3/1992	Brabeck et al.	D9/560
D337,274 S *	7/1993	Thatcher	D9/539
D339,503 S *	9/1993	Callaway	D7/510
D391,448 S *	3/1998	Winer et al.	D7/510
D398,478 S *	9/1998	Spencer	D7/510
D421,547 S *	3/2000	Demers	D7/510
D463,983 S *	10/2002	Wendt et al.	D9/558
D479,949 S *	9/2003	Janky	D7/511
D500,936 S *	1/2005	Nikkhah	D7/510
D501,361 S *	2/2005	Tollman	D7/510
D510,235 S *	10/2005	Sorensen	D7/510
D510,270 S *	10/2005	Khalifa	D9/503
D515,869 S *	2/2006	Mills et al.	D7/510

D517,864 S *	3/2006	Yu	D7/510
D531,451 S *	11/2006	Bin	D7/510
D532,314 S *	11/2006	Todd	D9/552

OTHER PUBLICATIONS

“Igloo 2004;” © Jun. 2003 Igloo Products Corp., Houston, Texas.

* cited by examiner

Primary Examiner—M. N. Pandozzi

(74) *Attorney, Agent, or Firm*—Howrey LLP

(57) **CLAIM**

The ornamental design for a sports bottle, as shown and described.

DESCRIPTION

FIG. 1 is a front,top,left side perspective view of a sports bottle showing a first embodiment of our new design;

FIG. 2 is a front elevational view thereof;

FIG. 3 is a rear elevational view thereof;

FIG. 4 is a right side elevational view thereof;

FIG. 5 is a left side elevational view thereof;

FIG. 6 is a top plan view thereof;

FIG. 7 is a bottom plan view thereof;

FIG. 8 is a front, top, left-side perspective view of a sports bottle showing a second embodiment of our new design;

FIG. 9 is an enlarged front elevational view thereof;

FIG. 10 is an enlarged rear elevational view thereof;

FIG. 11 is an enlarged right side elevational view thereof;

FIG. 12 is an enlarged left side elevational view;

FIG. 13 is a top plan view thereof; and,

FIG. 14 is a bottom plan view thereof.

1 Claim, 6 Drawing Sheets

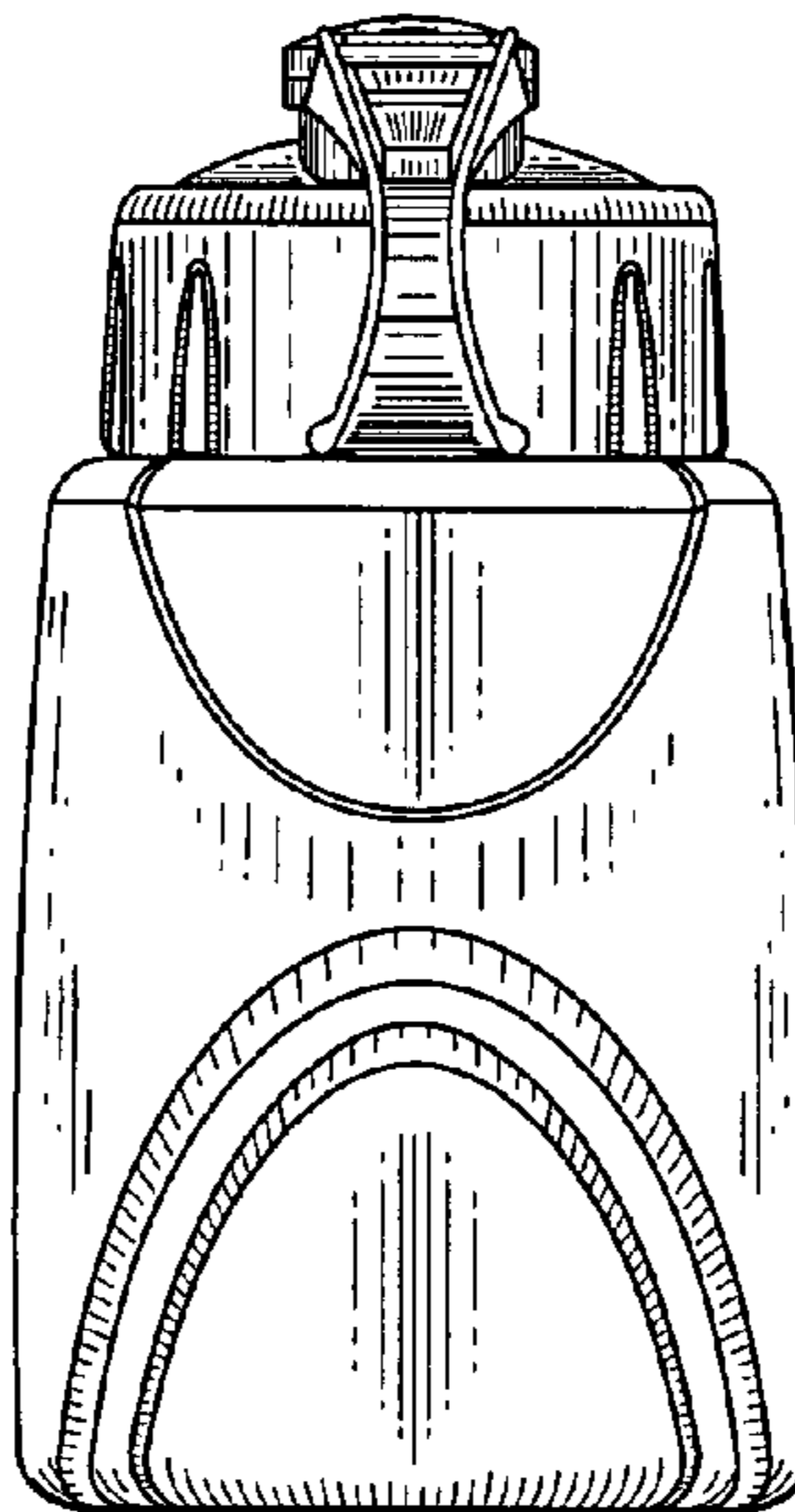
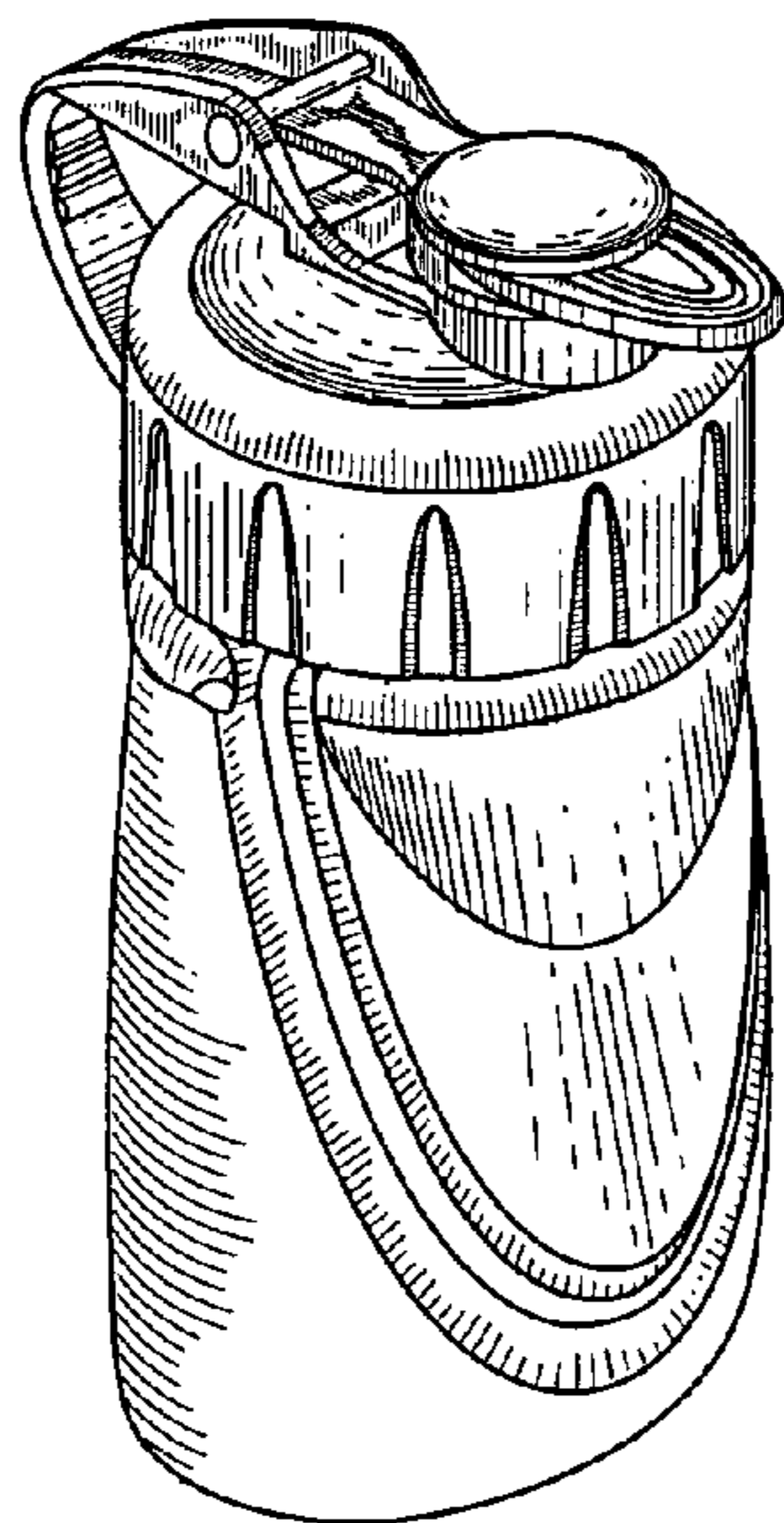

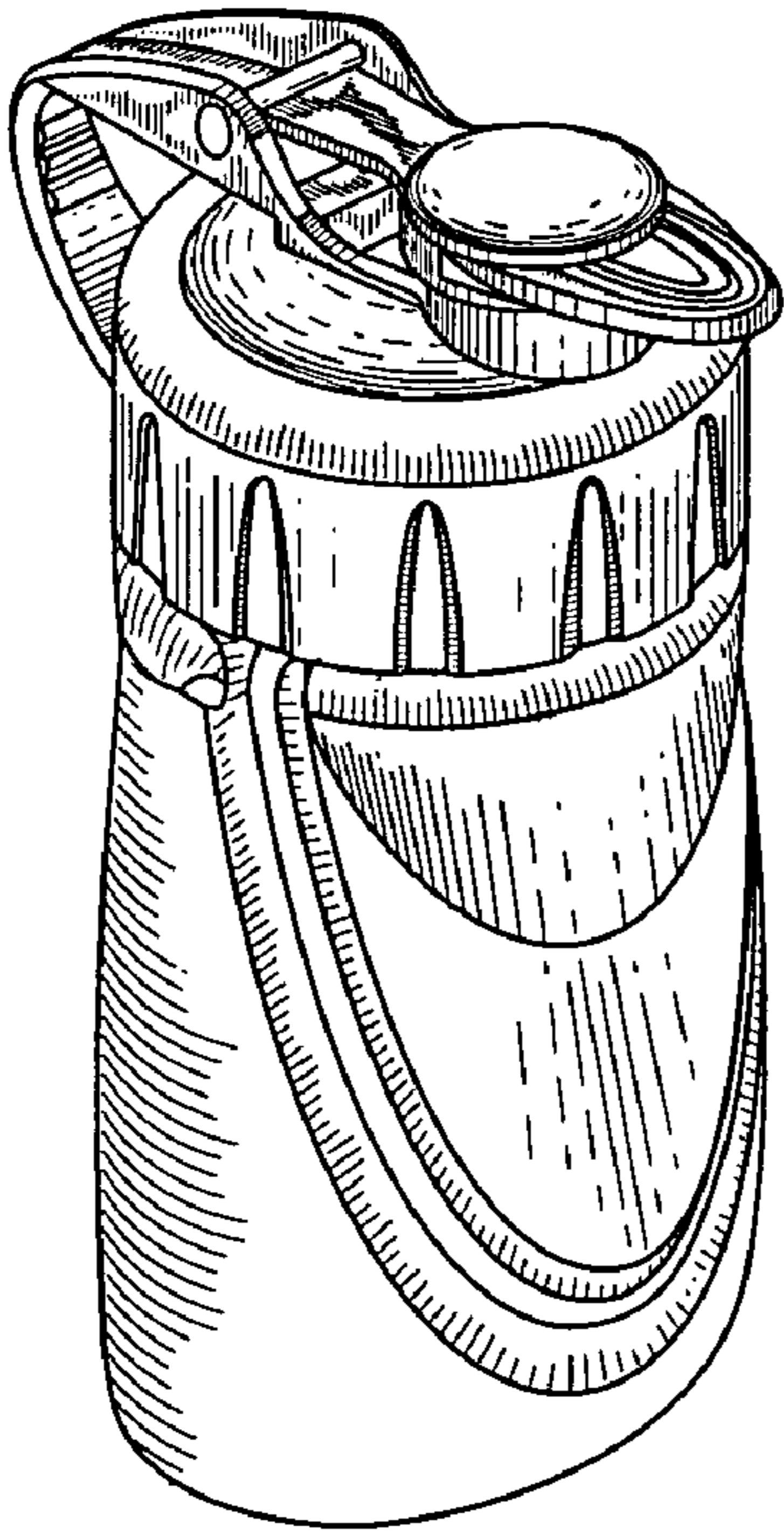

FIG. 1

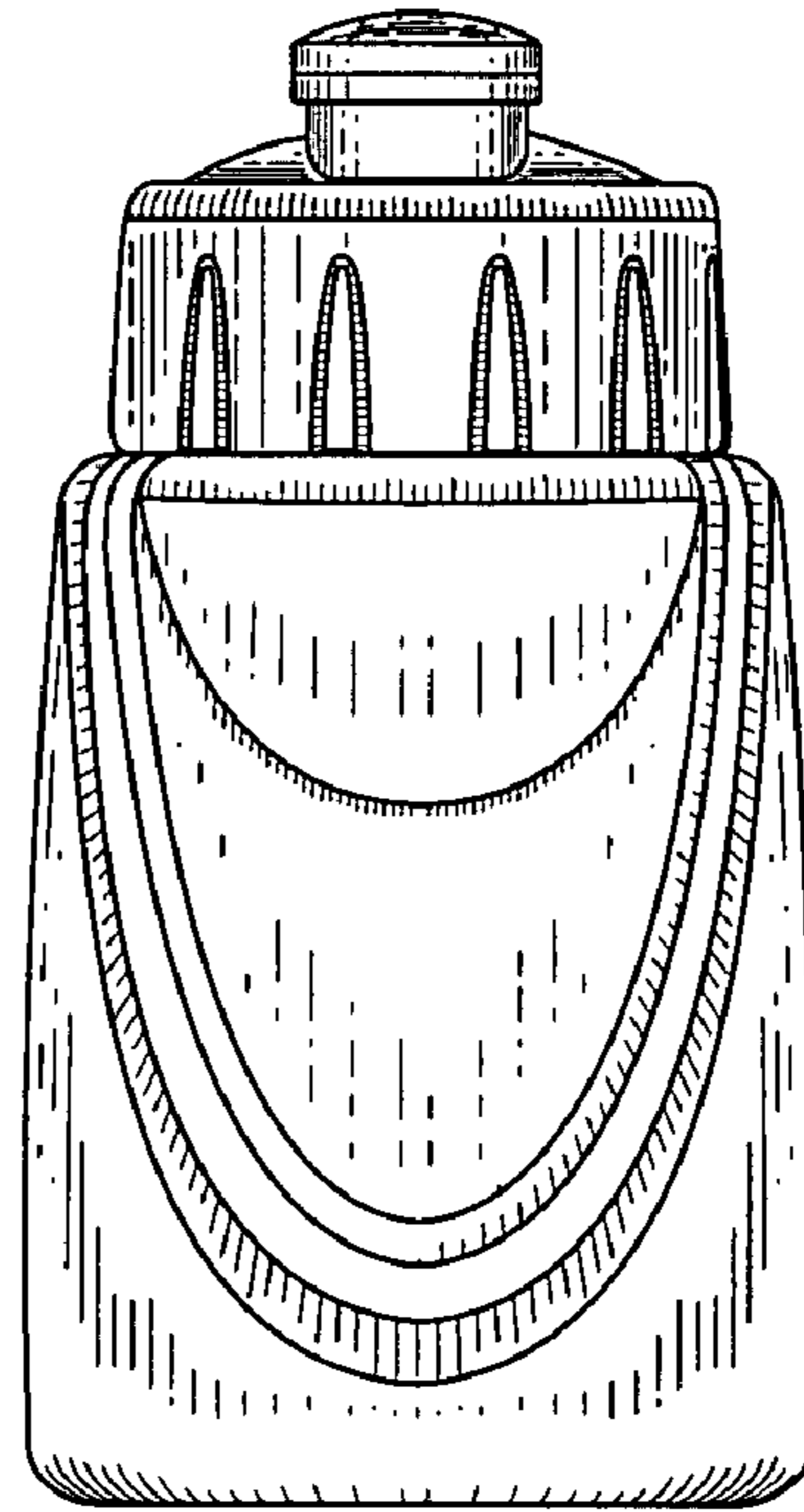

FIG. 2

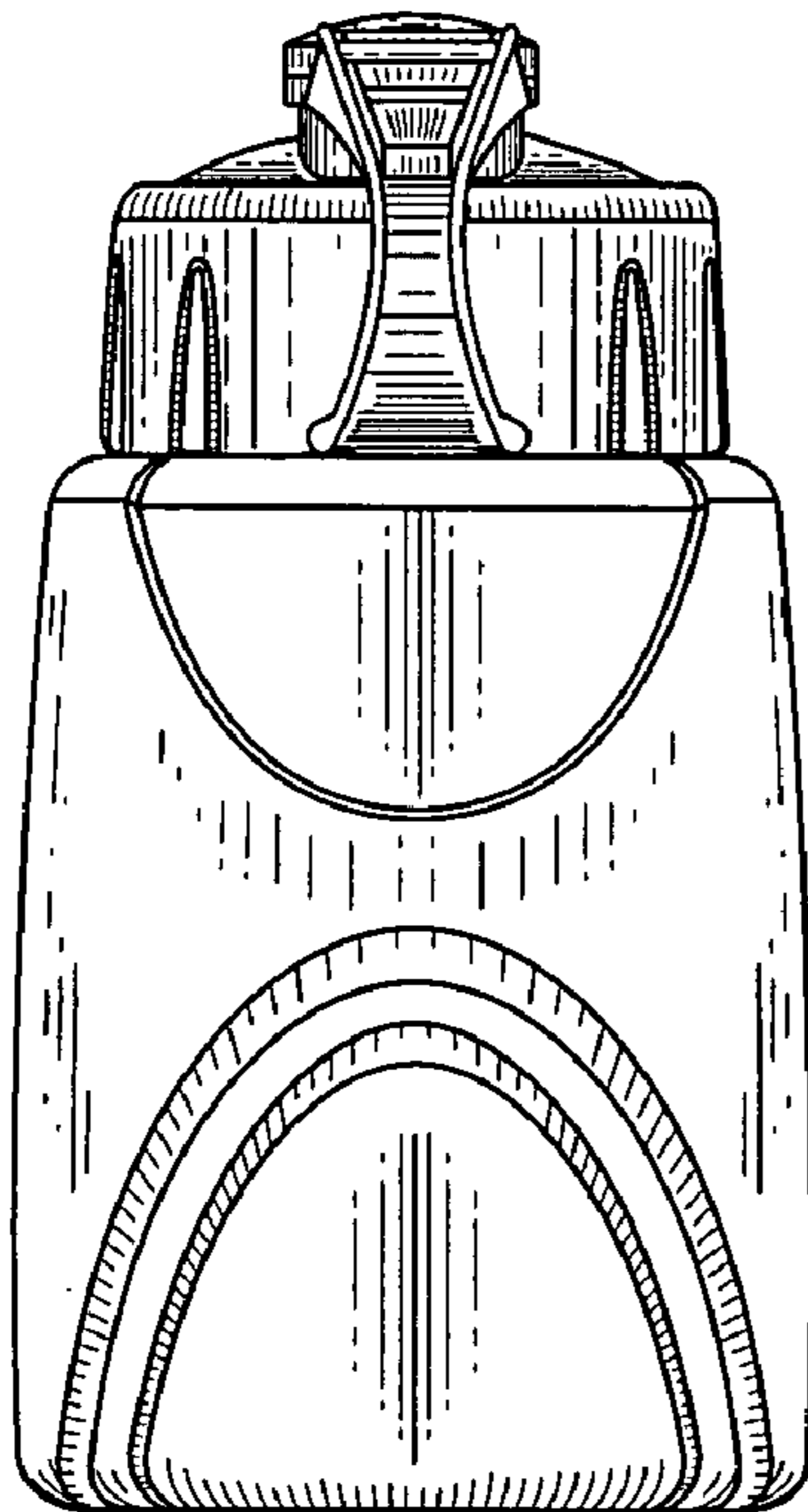

FIG. 3

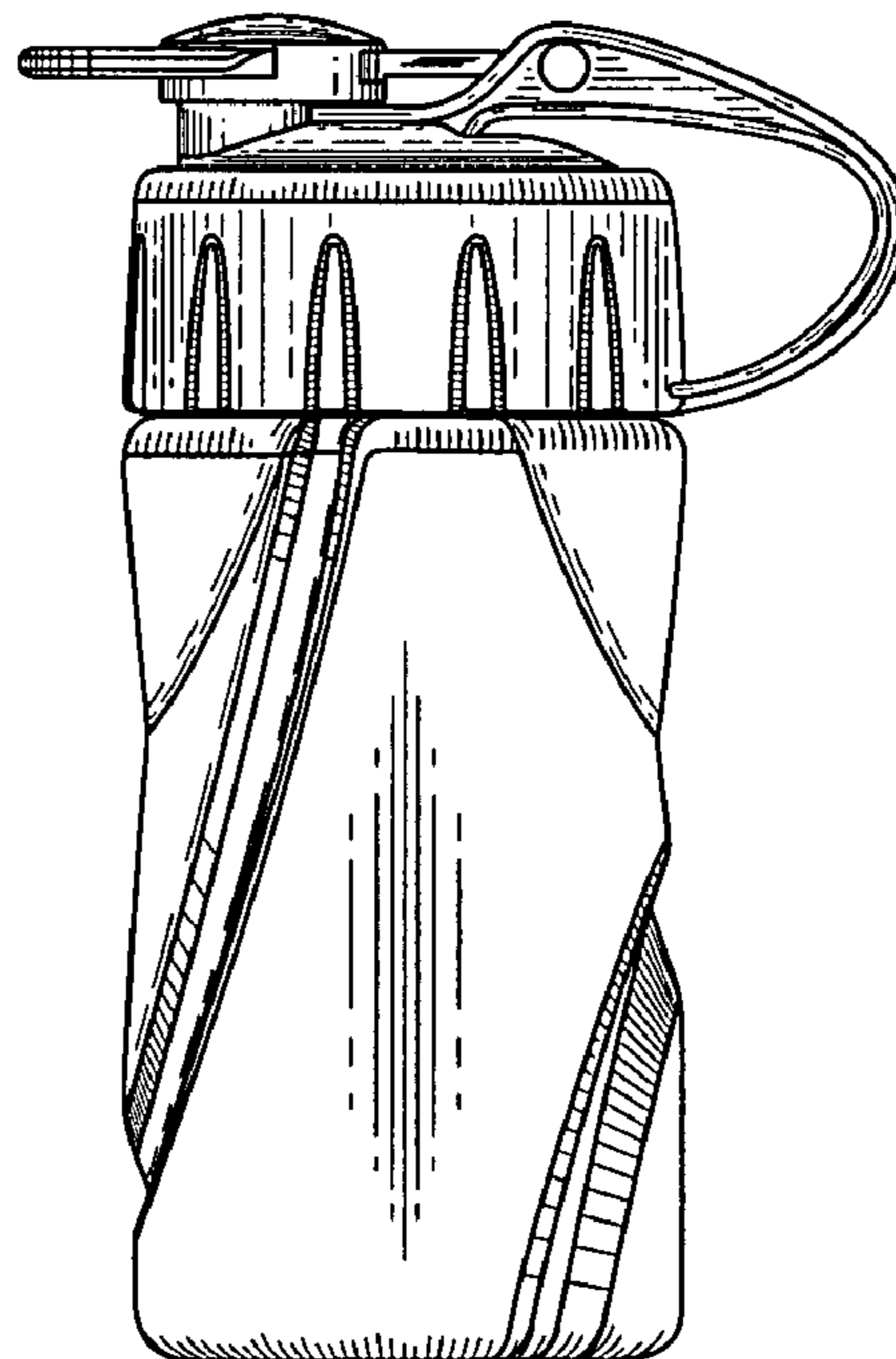

FIG. 4

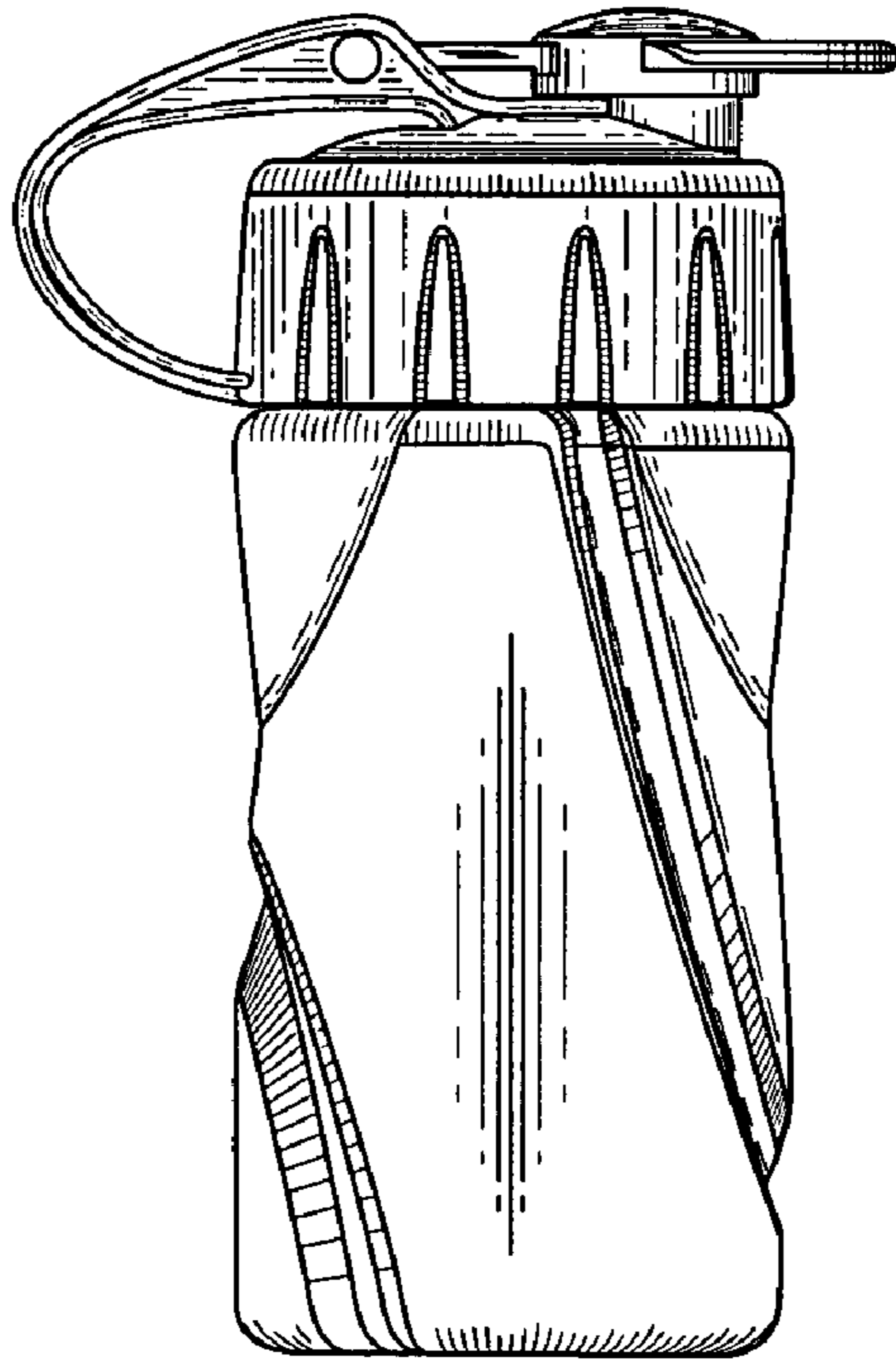

FIG. 5

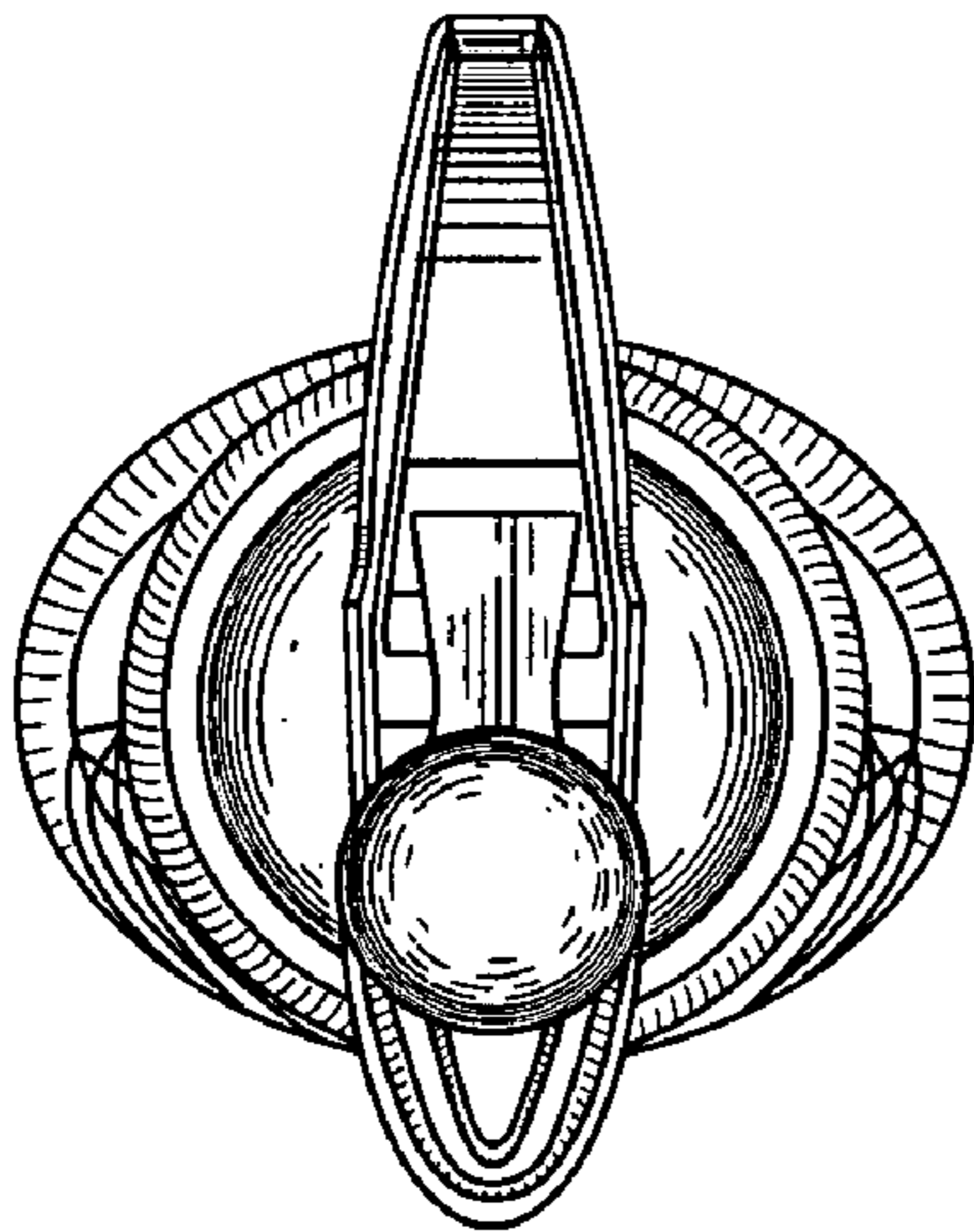

FIG. 6

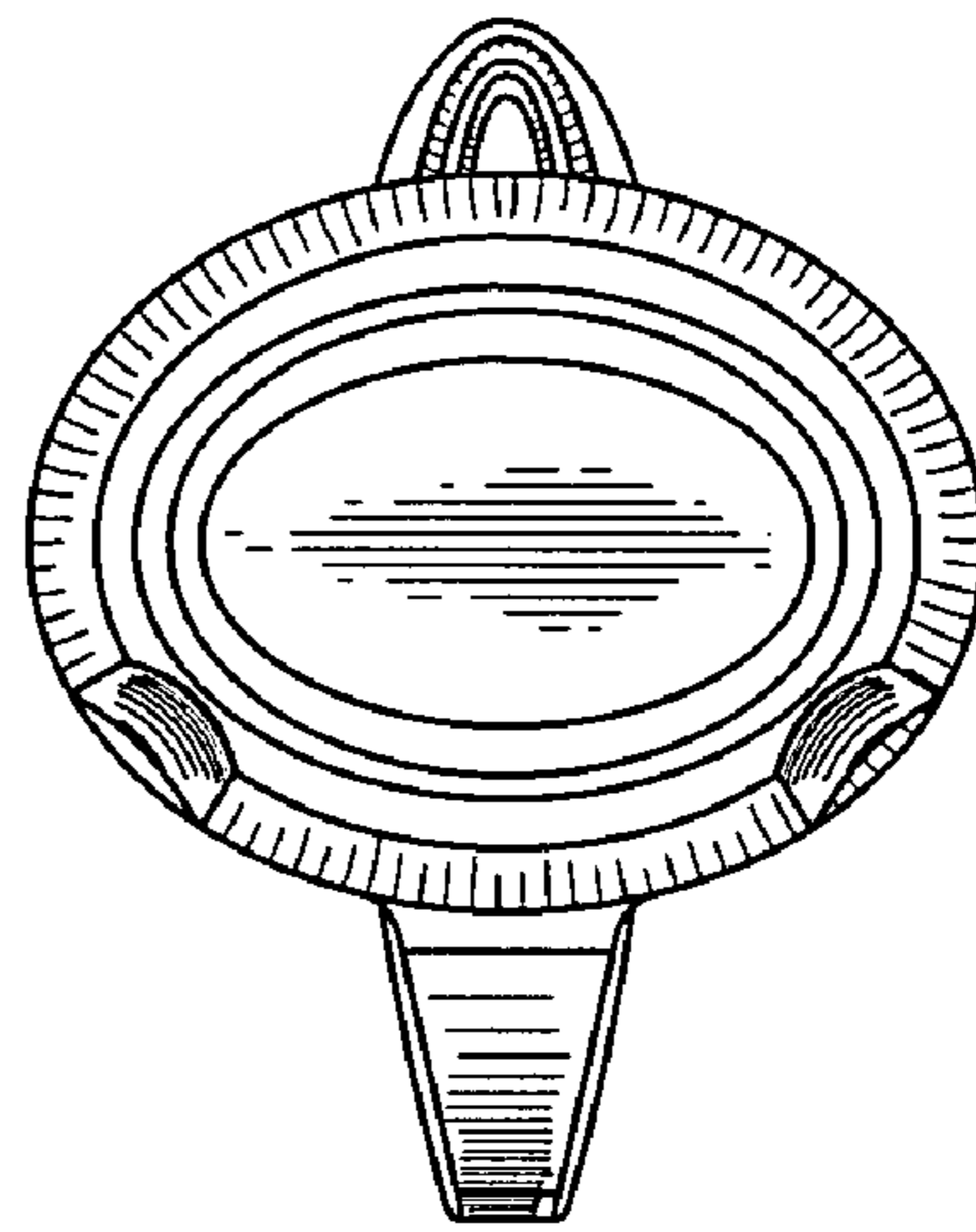

FIG. 7

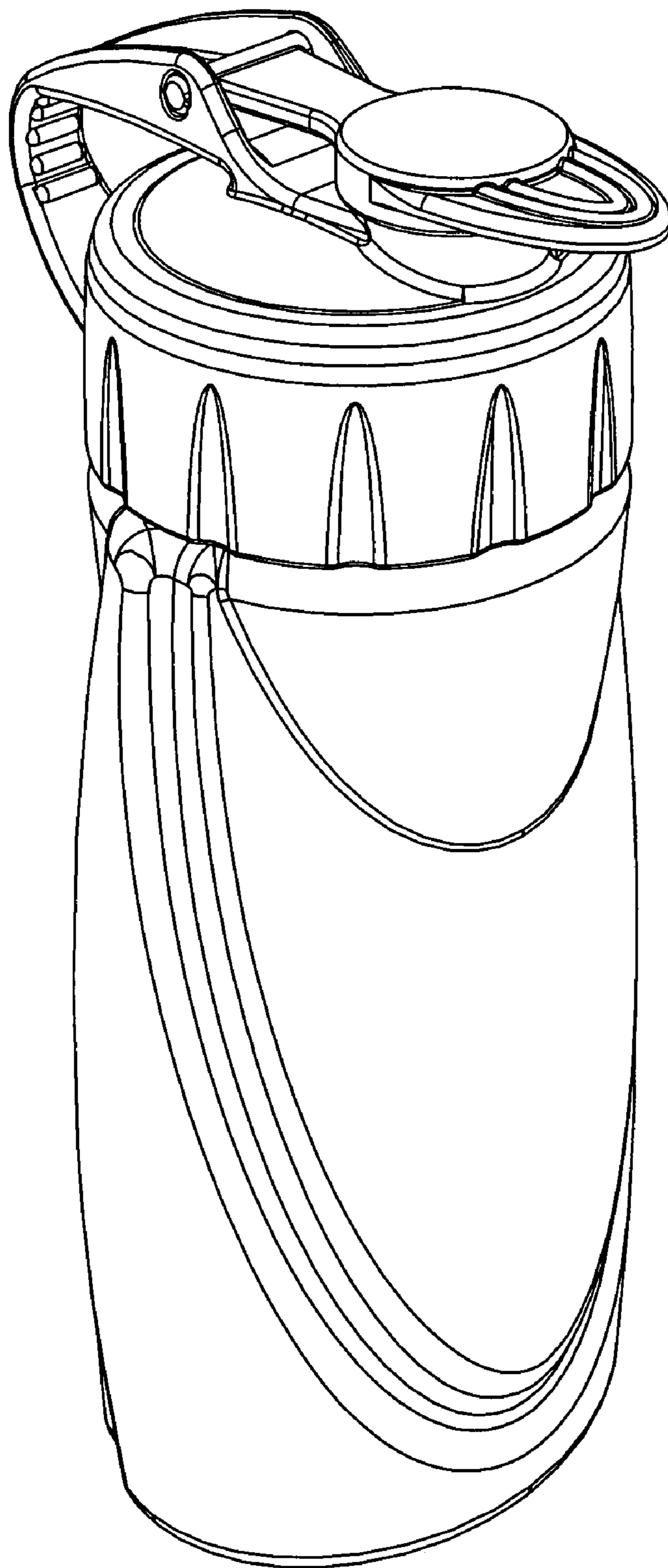

FIG. 8

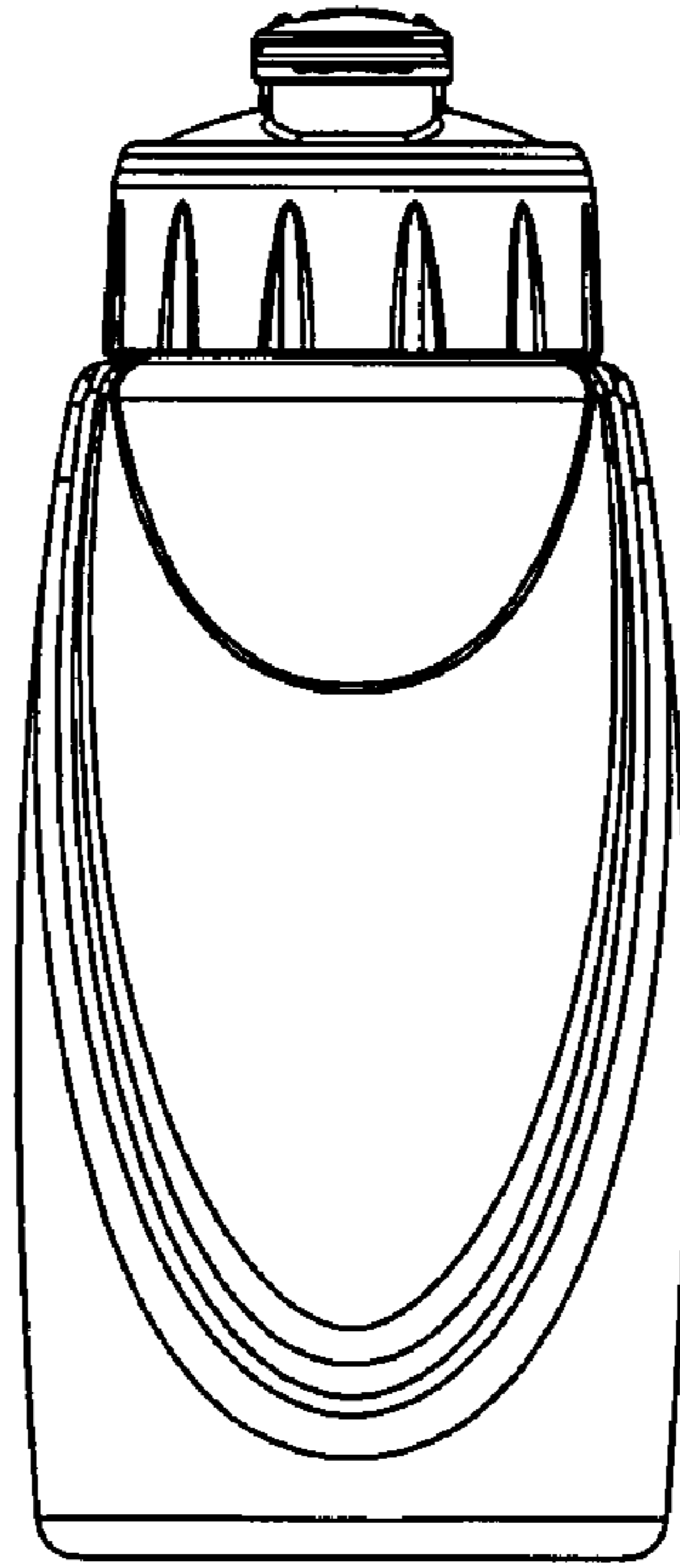

FIG. 9

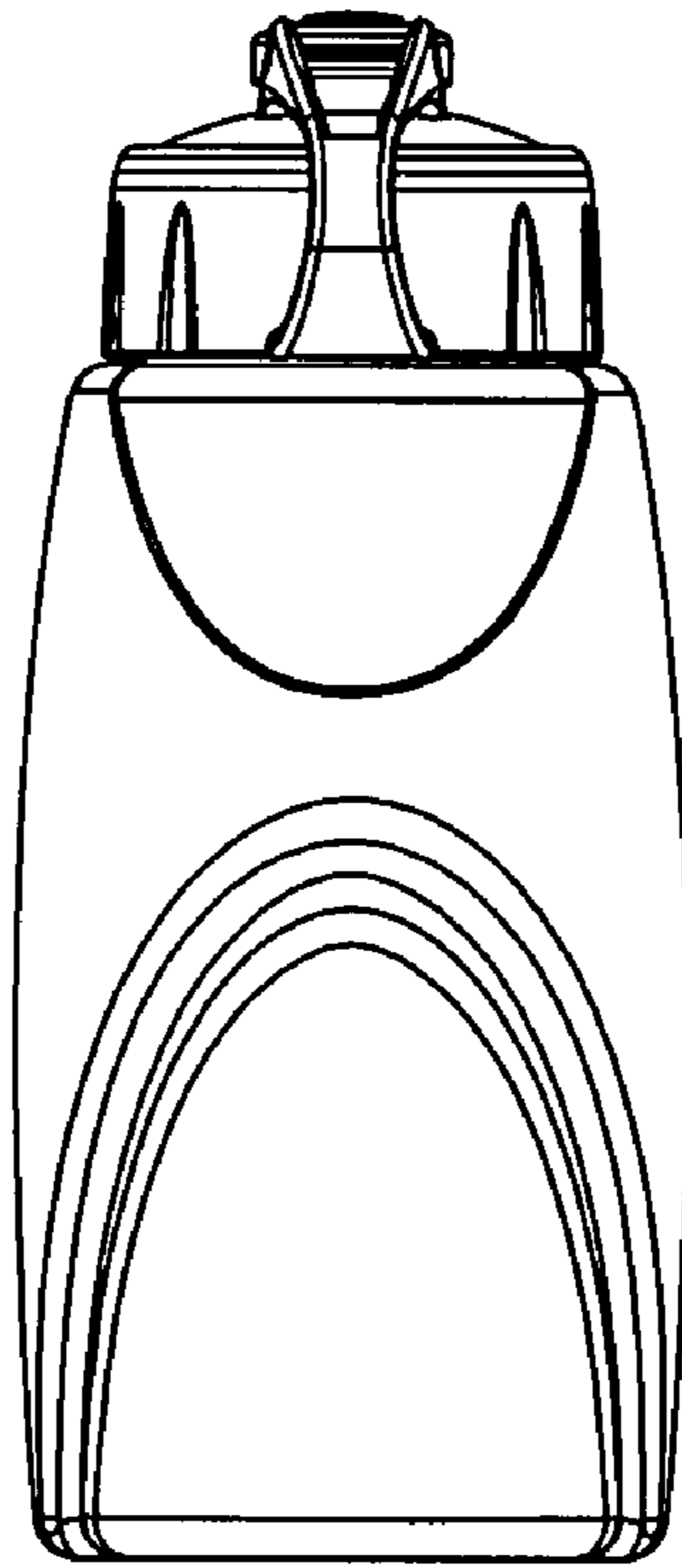

FIG. 10

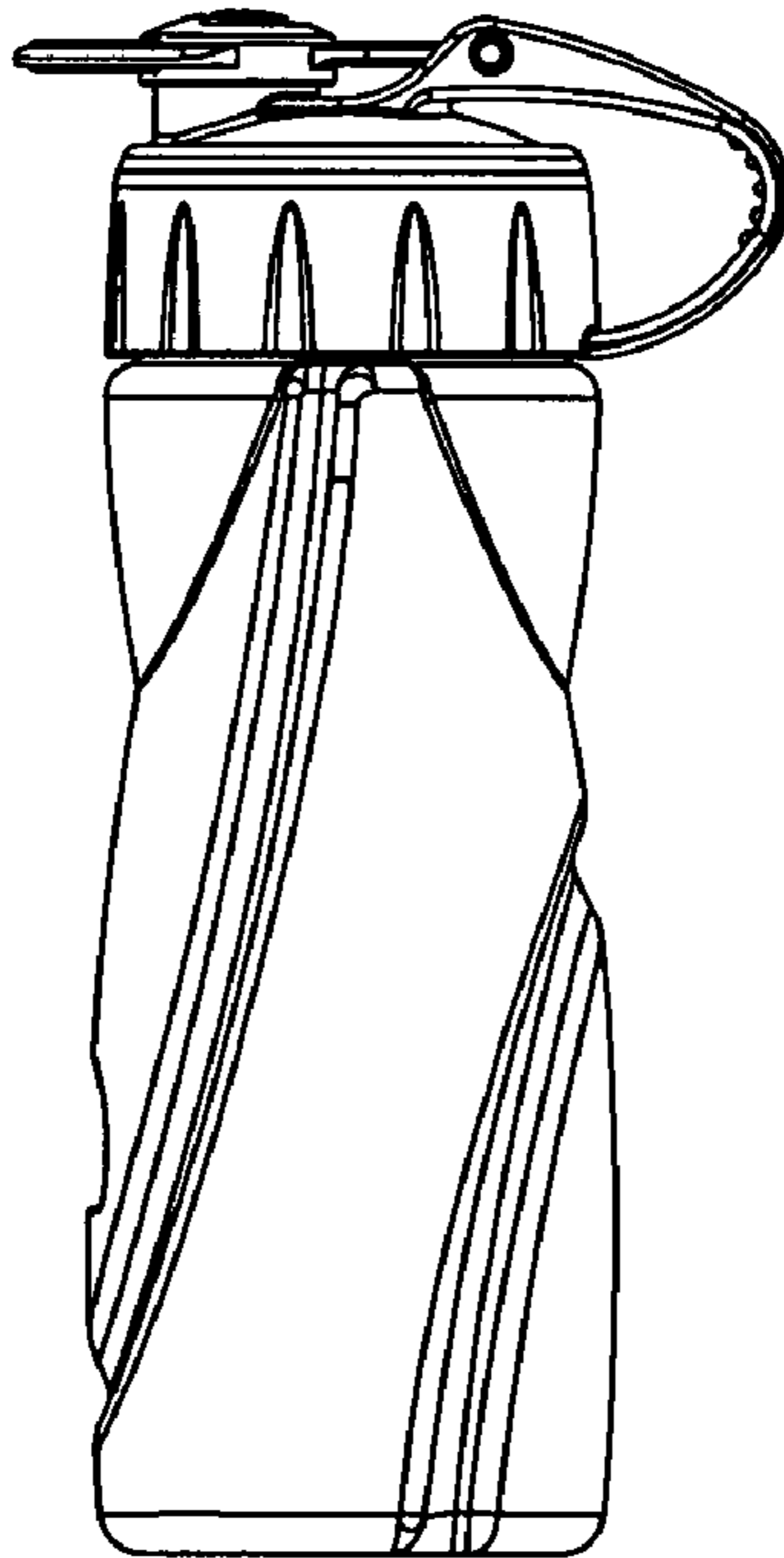

FIG. 11

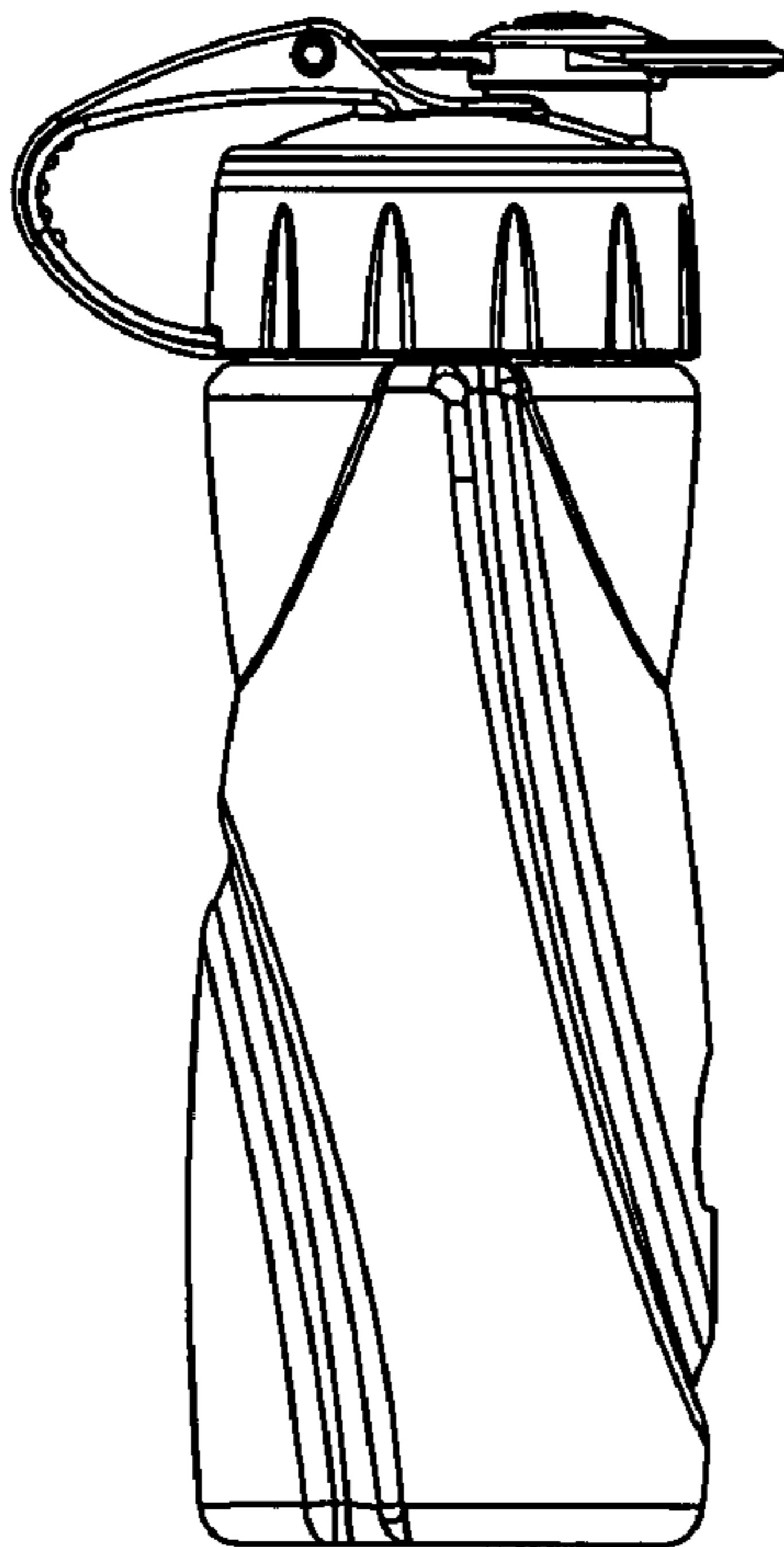

FIG. 12

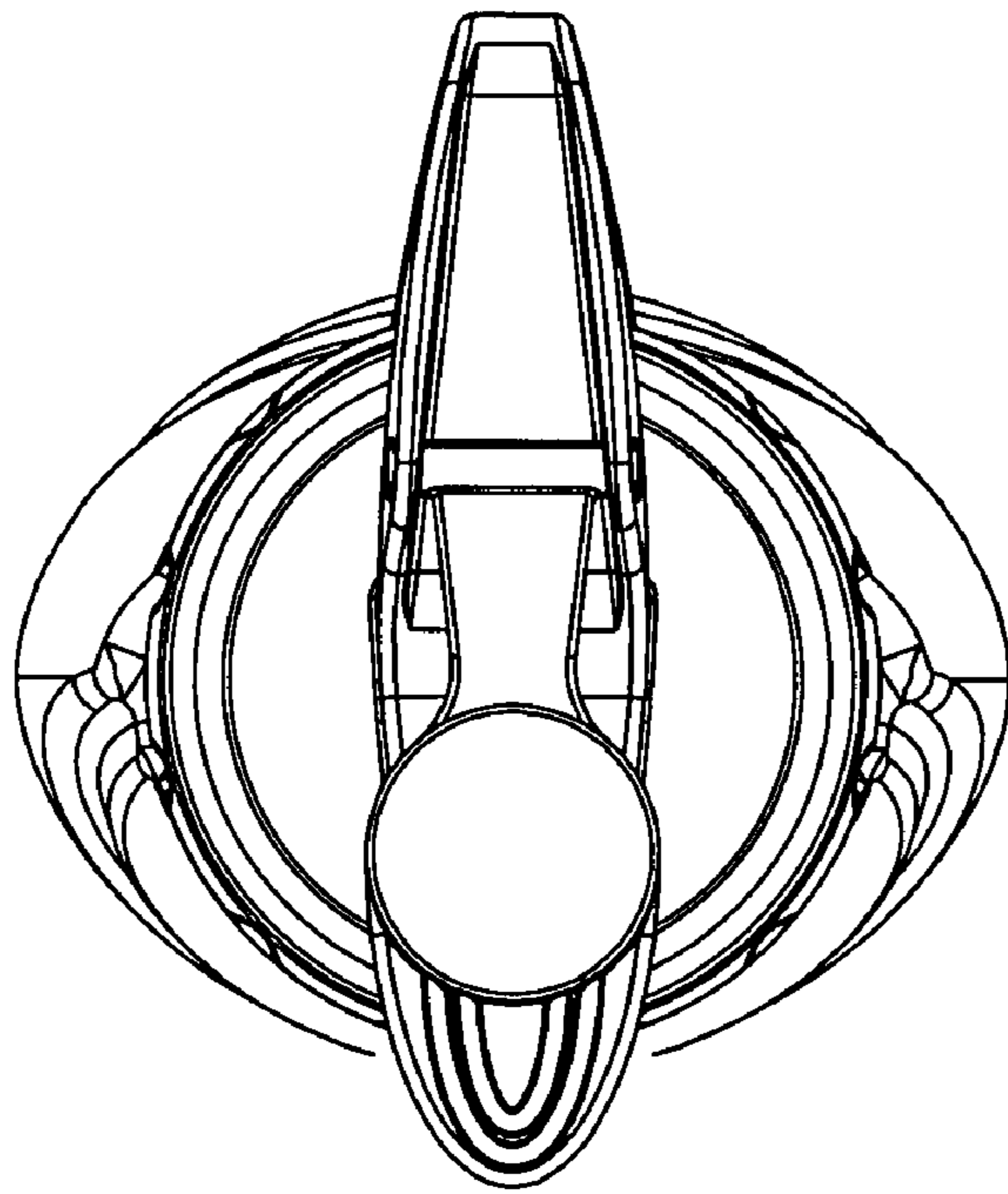

FIG. 13

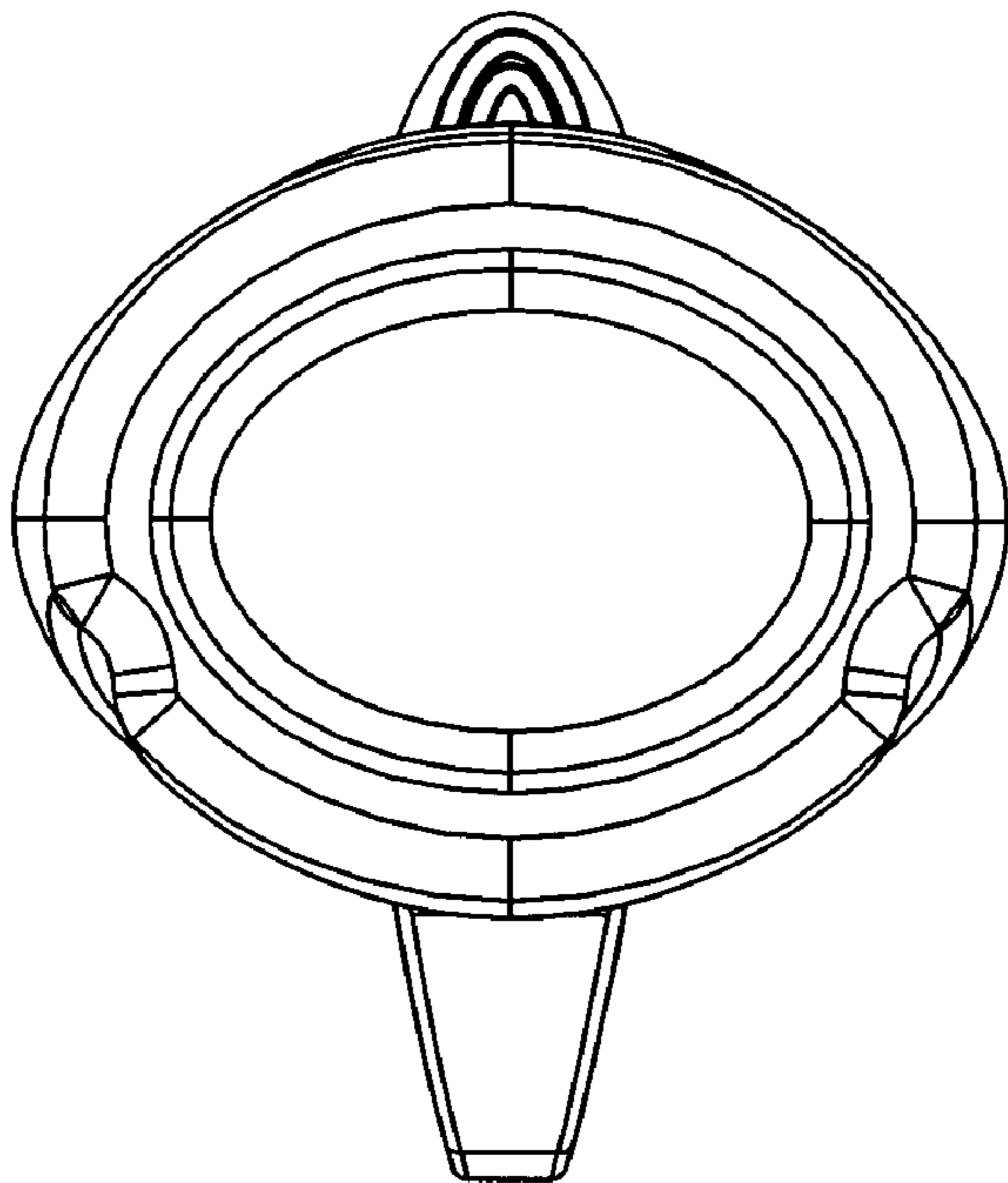

FIG. 14