



US00D549018S

(12) **United States Design Patent**  
**Glass et al.**

(10) **Patent No.:** **US D549,018 S**

(45) **Date of Patent:** **\*\* Aug. 21, 2007**

(54) **CHAIR BUCKET**

(75) Inventors: **Peter Glass**, Arroyo Grande, CA (US);  
**Robert J. Mills**, Torrance, CA (US)

(73) Assignee: **Virco Mgmt. Corporation**, Torrance,  
CA (US)

(\*\*) Term: **14 Years**

(21) Appl. No.: **29/272,843**

(22) Filed: **Feb. 20, 2007**

(51) **LOC (8) Cl.** ..... **06-06**

(52) **U.S. Cl.** ..... **D6/500; D6/375**

(58) **Field of Classification Search** ..... D6/334-336,  
D6/366, 371-373, 374, 375, 376, 379, 380,  
D6/500-502; 297/239, 448.1, 451.3, 452.12,  
297/452.14, 452.2, 452.46

See application file for complete search history.

(56) **References Cited**

**U.S. PATENT DOCUMENTS**

D142,800 S *	11/1945	Watson	.....	D6/375
D174,927 S *	6/1955	Shannon	.....	D6/375
2,745,468 A	5/1956	Kramer		
D178,880 S *	10/1956	Hauser	.....	D6/375
D182,790 S *	5/1958	Cohen	.....	D6/375
D189,347 S *	11/1960	Chapman et al.	.....	D6/375
D192,559 S	4/1962	Chapman		
D193,657 S	9/1962	Van Buren, Jr.		
D193,708 S	10/1962	Keown		
D197,643 S	3/1964	Kramer		
D200,640 S	3/1965	Yamasaki		
3,201,172 A	8/1965	Bliss		
D202,548 S	10/1965	Kramer		
D202,549 S	10/1965	Kramer		
D202,550 S	10/1965	Kramer		
D210,940 S	5/1968	Eames		
D214,622 S	7/1969	Scheier et al.		

D236,670 S *	9/1975	Uyeda	.....	D6/375
D237,330 S	10/1975	Skyer		
D240,373 S	7/1976	Morton		
D248,810 S *	8/1978	Day	.....	D6/375
D254,042 S	1/1980	Hosoe		
D281,941 S	12/1985	Ambasz et al.		
D295,585 S	5/1988	Mulhauser		
D307,837 S	5/1990	Grant		
5,123,702 A *	6/1992	Caruso	.....	297/239
D358,514 S	5/1995	Lovegrove		
D360,083 S *	7/1995	Lohmeyer	.....	D6/375

(Continued)

**OTHER PUBLICATIONS**

Virco Equipment for Educators catalog, p. 6, Nov. 2005.

*Primary Examiner*—Mimosa De

(74) *Attorney, Agent, or Firm*—Robert M. Hupe; Virco  
Mgmt. Corporation

(57) **CLAIM**

The ornamental design for a “chair bucket,” as shown and  
described.

**DESCRIPTION**

FIG. 1 is a top perspective view of a chair bucket showing  
my new design;

FIG. 2 a front view thereof;

FIG. 3 is a left side view thereof, the opposite side view  
being a mirror image thereof;

FIG. 4 is a top view thereof;

FIG. 5 is a bottom view thereof;

FIG. 6 is a back view thereof; and,

FIG. 7 is a top back perspective view thereof.

The broken lines are for illustrative purposes only and form  
no part of the claimed design.

**1 Claim, 4 Drawing Sheets**

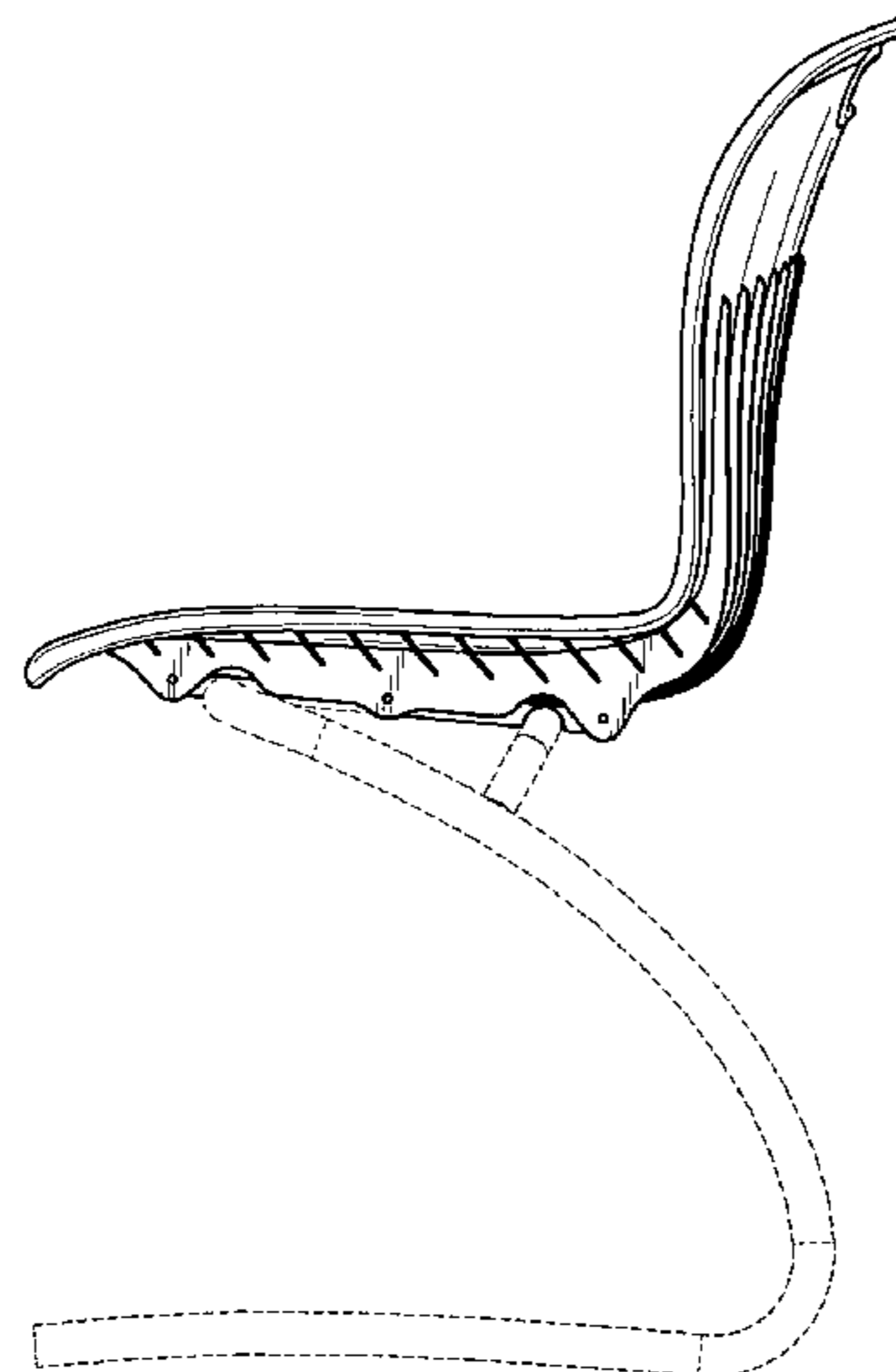
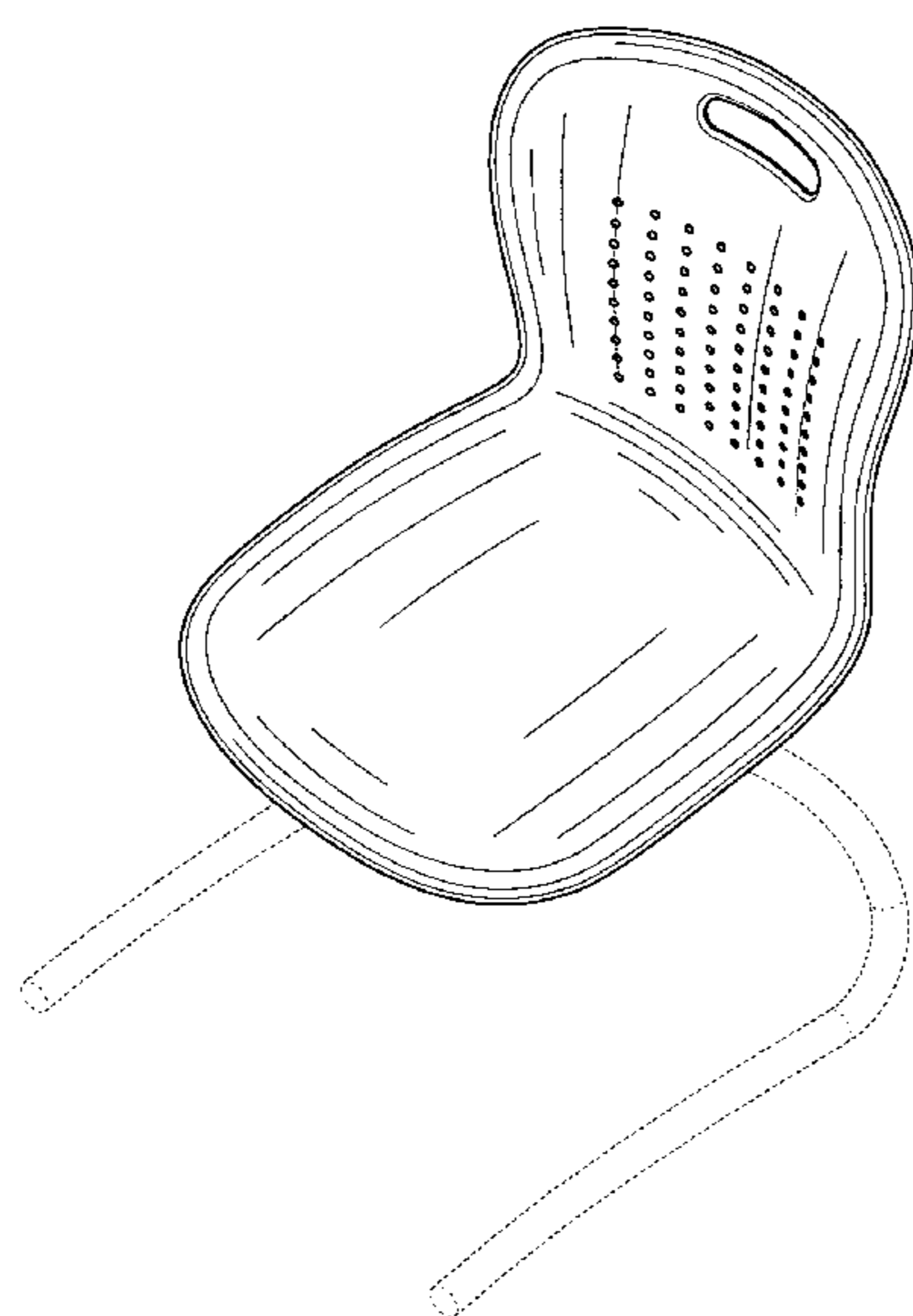

# US D549,018 S

Page 2

---

## U.S. PATENT DOCUMENTS

D409,407 S	5/1999	Wang		
D410,801 S	6/1999	Holbrook		
D414,618 S	10/1999	Holbrook		
D422,805 S *	4/2000	Smith .....	D6/373	
D456,164 S *	4/2002	Vanderiet et al. ....	D6/374	
D470,320 S	2/2003	Schloss		
D471,729 S *	3/2003	Glass et al. ....	D6/375	
D471,730 S	3/2003	Schloss		
D473,407 S	4/2003	Ross		
D493,642 S	8/2004	Maran		
D494,789 S	8/2004	Brown		
D497,065 S	10/2004	Lucci et al.		
D499,260 S	12/2004	Glass et al.		
D503,559 S *	4/2005	Glass et al. ....	D6/372	
D507,893 S *	8/2005	Glass et al. ....	D6/375	
D508,340 S	8/2005	Barbieri		
D513,911 S *	1/2006	Glass et al. ....	D6/502	
D514,339 S *	2/2006	Glass et al. ....	D6/366	
D526,134 S *	8/2006	Glass et al. ....	D6/375	
D541,067 S *	4/2007	Lin .....	D6/373	

\* cited by examiner

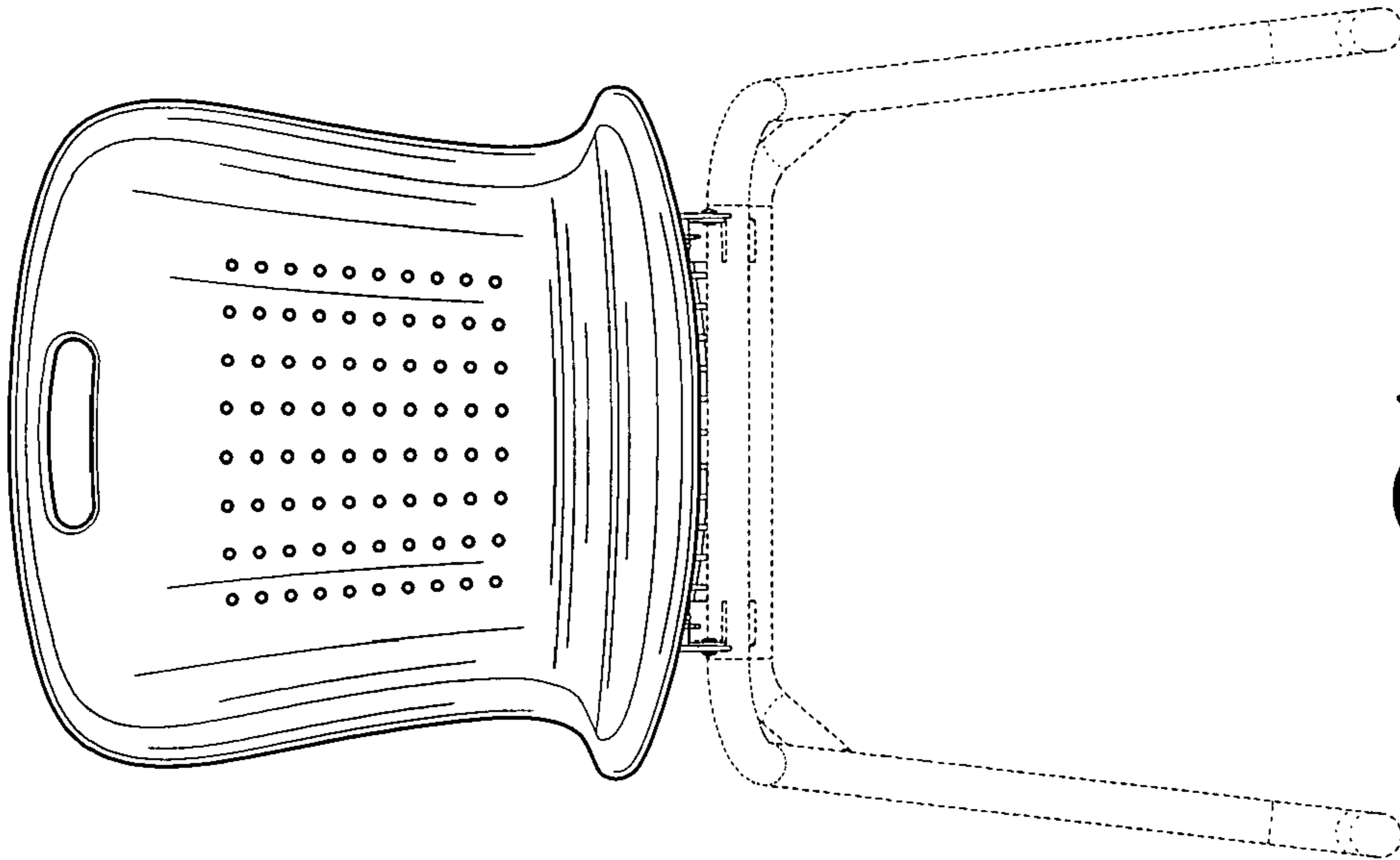

FIG. 2

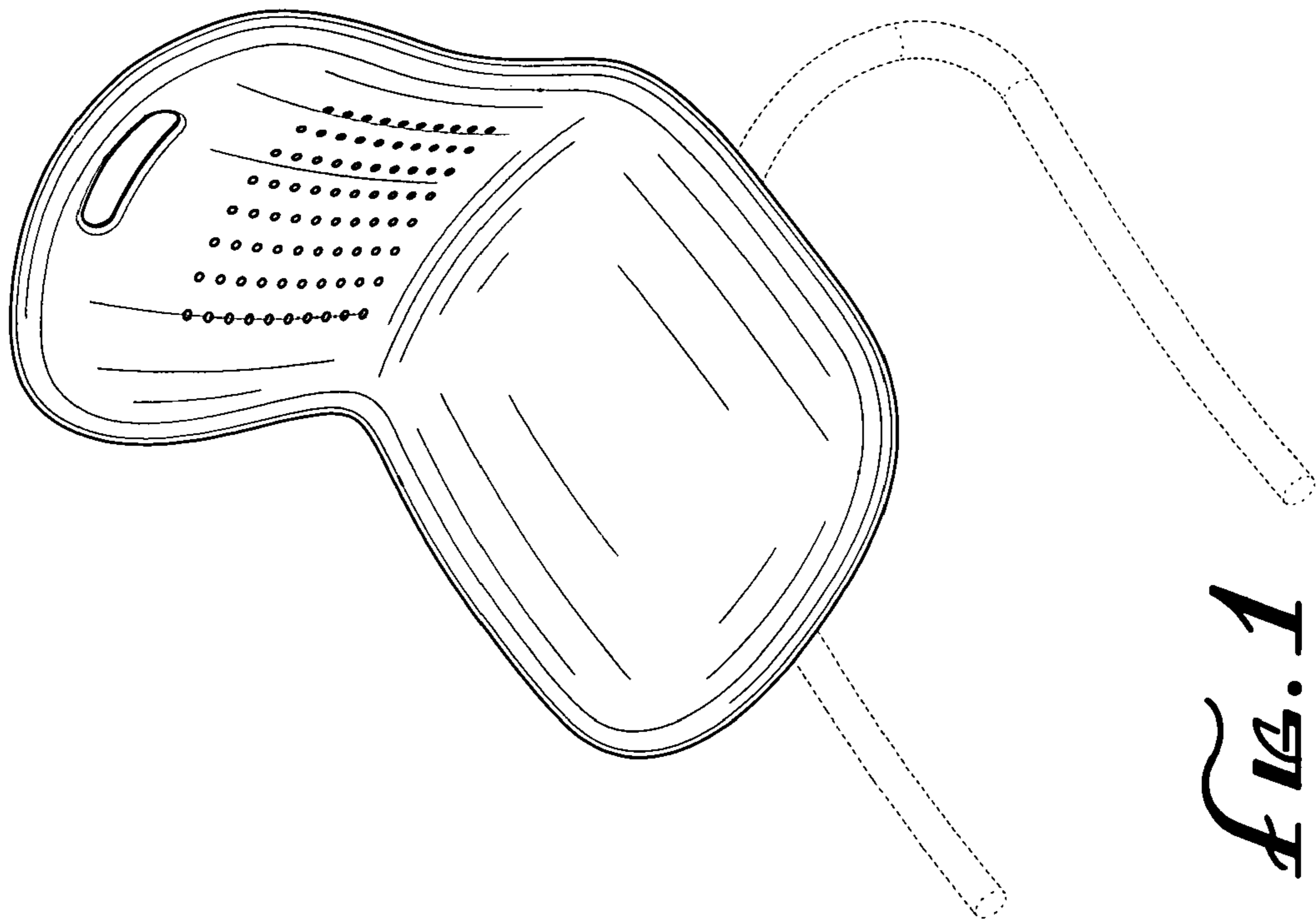
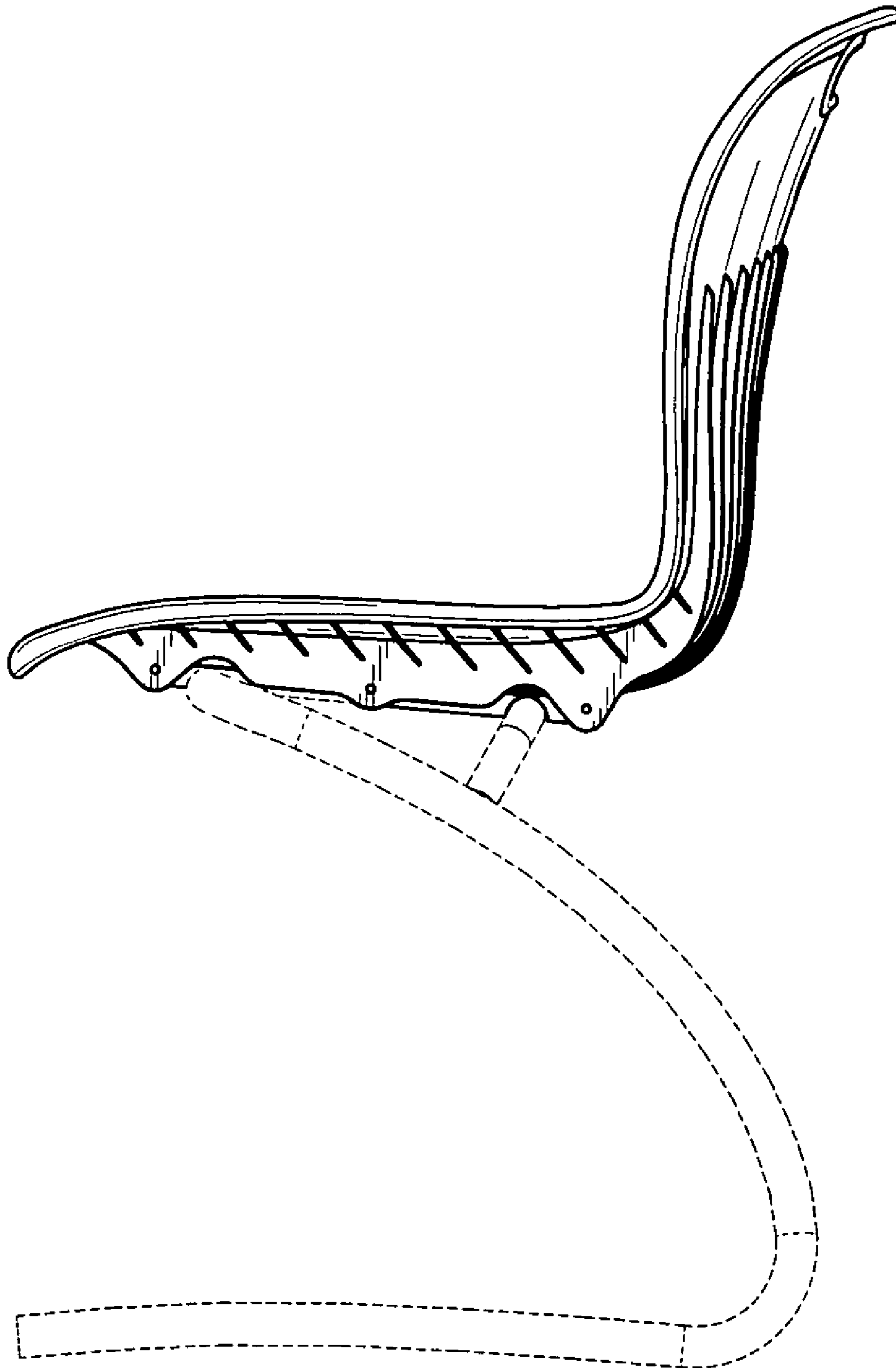
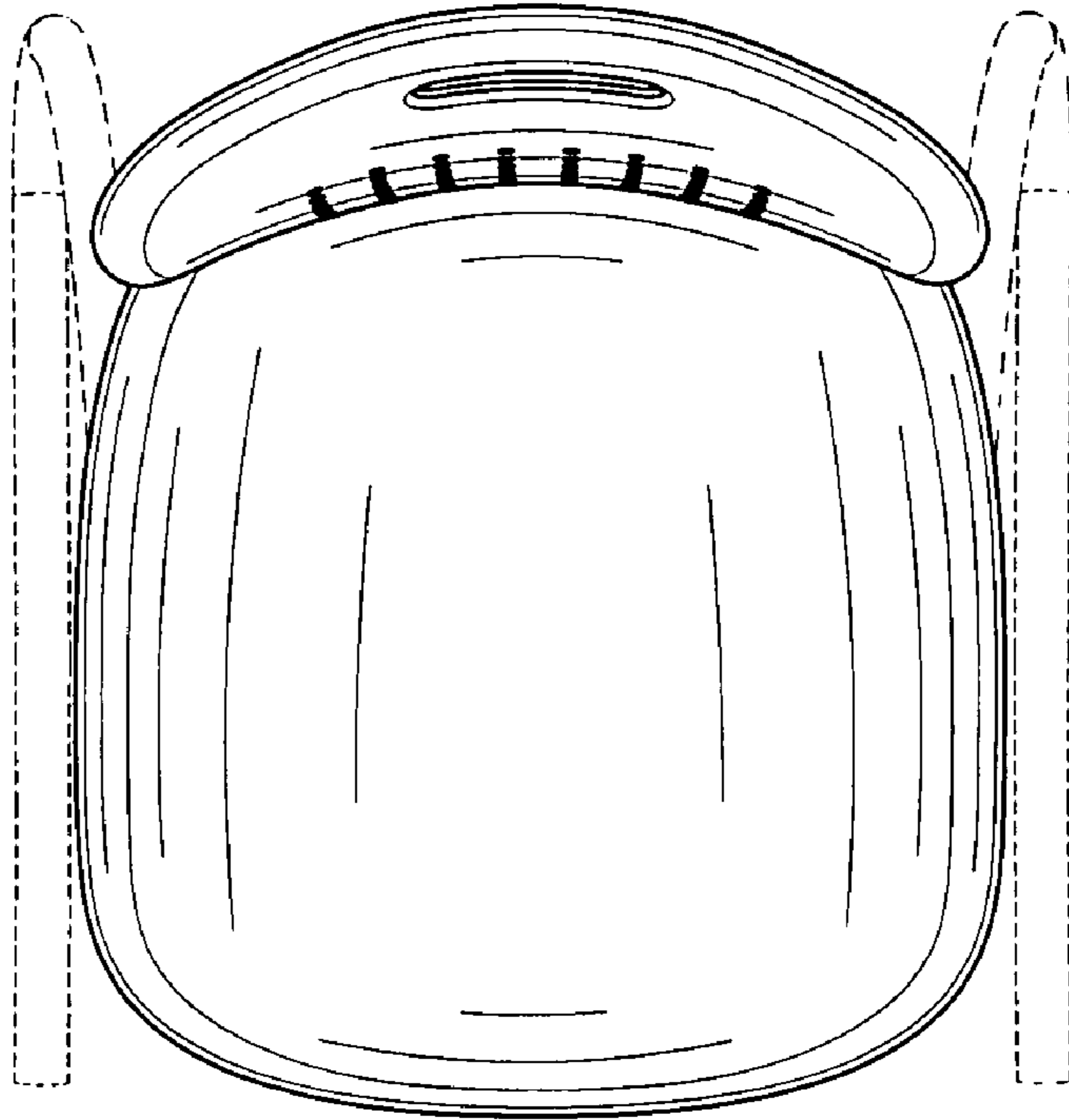

FIG. 1

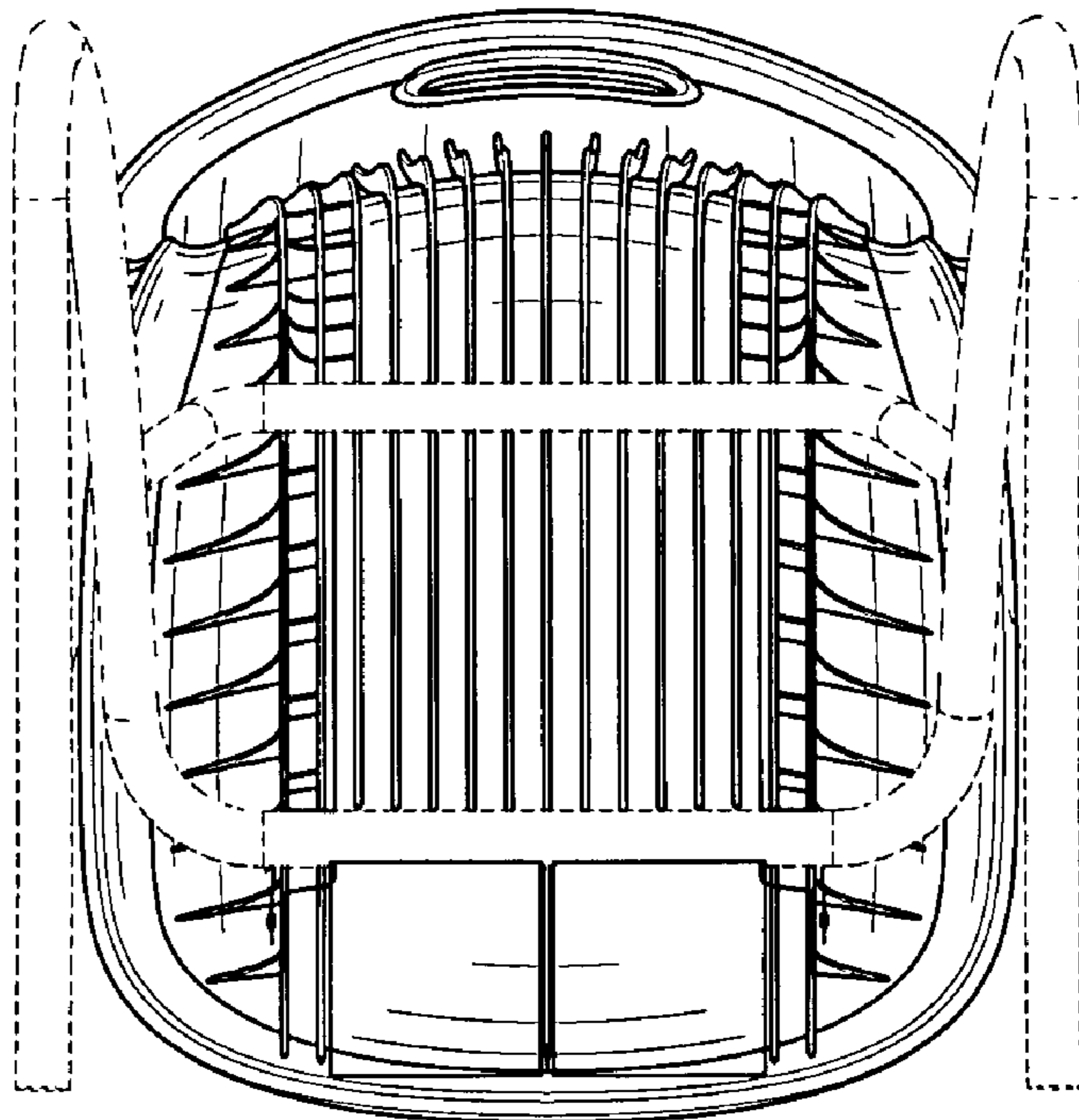

*FIG. 3*

*FIG. 4*



*FIG. 5*





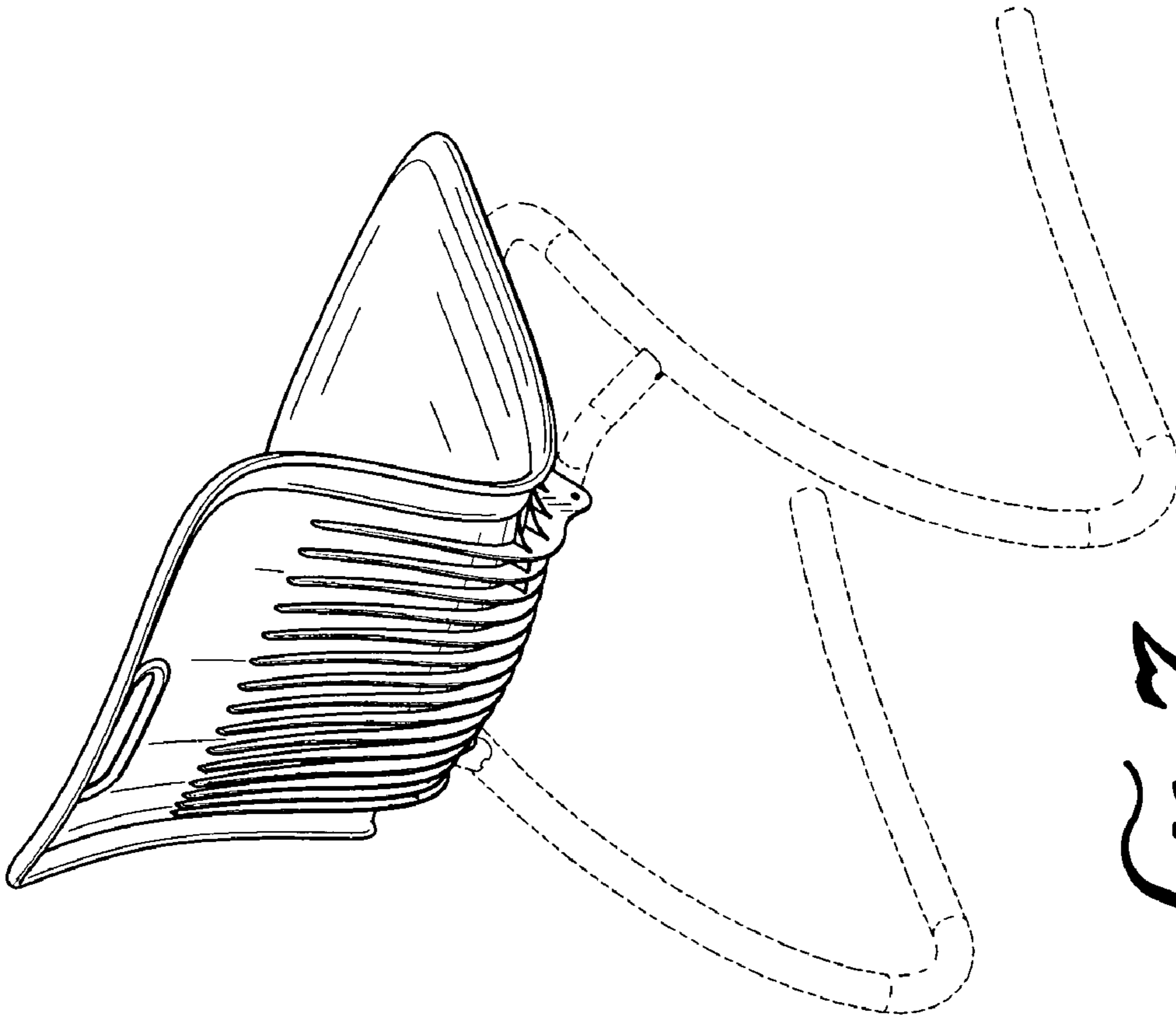

FIG. 1

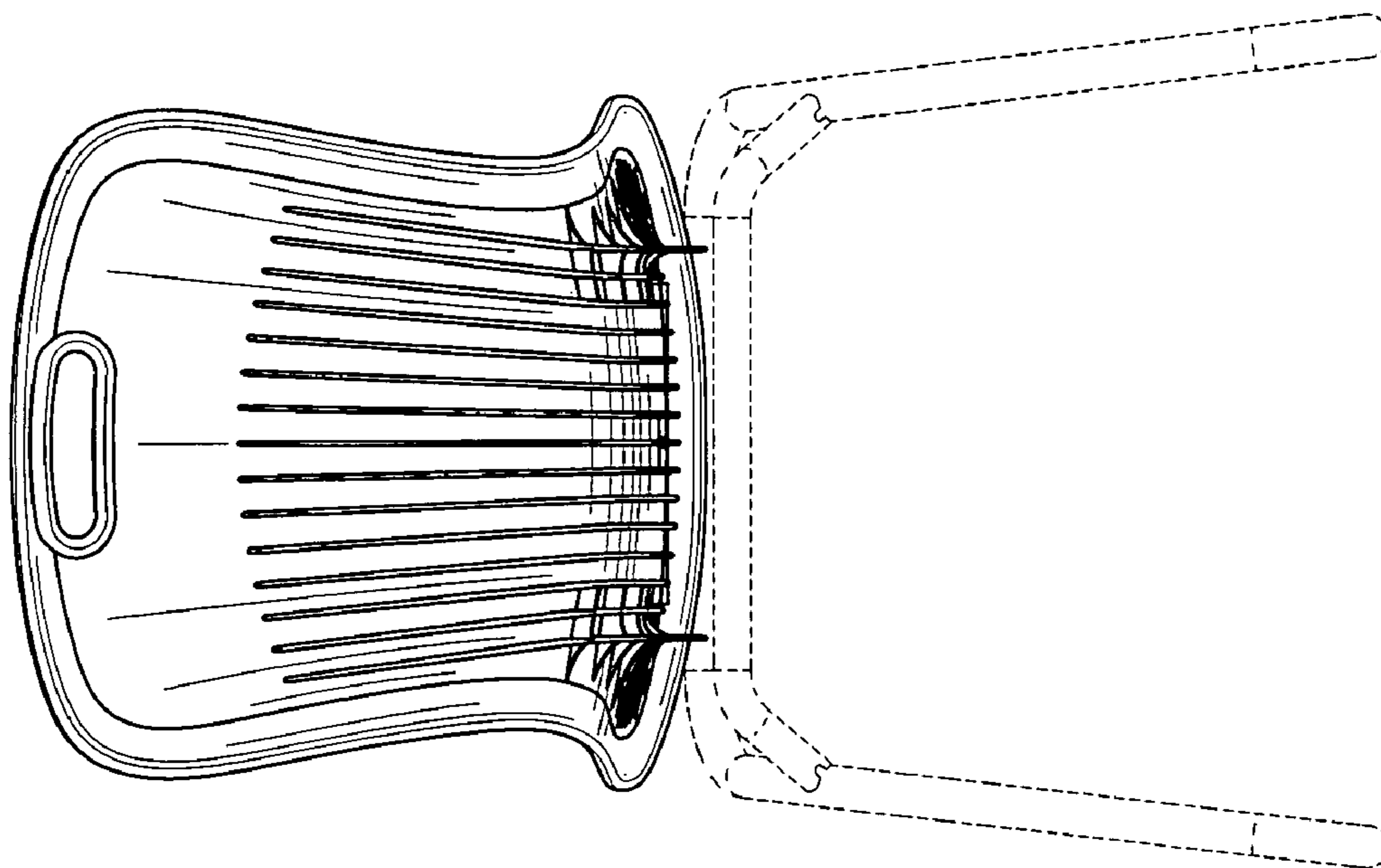

FIG. 2