

US00D549010S

(12) **United States Design Patent** (10) **Patent No.:** **US D549,010 S**
Sorci (45) **Date of Patent:** **** Aug. 21, 2007**

(54) **SQUARE TABLE**

(76) **Inventor:** **Joseph Peter Sorci**, 427 Chestnut St.,
Nashville, TN (US) 37203

(**) **Term:** **14 Years**

(21) **Appl. No.:** **29/253,694**

(22) **Filed:** **Feb. 10, 2006**

(51) **LOC (8) Cl.** **06-03**

(52) **U.S. Cl.** **D6/484; D6/349**

(58) **Field of Classification Search** D6/480-489,
D6/495-499, 511, 429, 349, 355; 108/150,
108/153.1, 155, 156; 248/188, 188.1, 188.8;
297/461, 462

See application file for complete search history.

(56) **References Cited**

U.S. PATENT DOCUMENTS

795,957 A	8/1905	Cartland	
1,422,613 A	7/1922	Ogden	
2,005,715 A	6/1935	Kovats	155/148
2,615,770 A	10/1952	Curtis	311/35
D168,167 S *	11/1952	Molla	D6/480
2,731,316 A	1/1956	Cohen	311/4
2,903,312 A	9/1959	Lawless	311/35
3,087,758 A	4/1963	Deaton	297/445
D195,854 S *	8/1963	Schwarz	D6/495
3,556,594 A	1/1971	Anderson	297/452
D244,076 S *	4/1977	Saltz	D6/484
D245,135 S *	7/1977	Saltz	D6/484

D328,829 S *	8/1992	Wisner	D6/436
D329,553 S *	9/1992	White	D6/484
5,865,129 A	2/1999	Samples	108/157.17
D461,061 S *	8/2002	Kent	D6/336
D504,578 S *	5/2005	Moser	D6/349

* cited by examiner

Primary Examiner—Janice E. Seeger
(74) *Attorney, Agent, or Firm*—Waddey & Patterson, P.C.;
Edward D. Lanquist, Jr.

(57) **CLAIM**

What is claimed is the ornamental design for a square table,
as shown and described.

DESCRIPTION

FIG. 1 is a front elevation view showing the square table of
applicant's invention.

FIG. 2 is an end view of the square table of applicant's
invention.

FIG. 3 is a plan view of the square table of applicant's
invention.

FIG. 4 is an underneath view of the square table of appli-
cant's invention.

FIG. 5 is a top perspective view showing the square table of
applicant's invention; and,

FIG. 6 is a lower perspective view showing the square table
of applicant's invention.

1 Claim, 5 Drawing Sheets

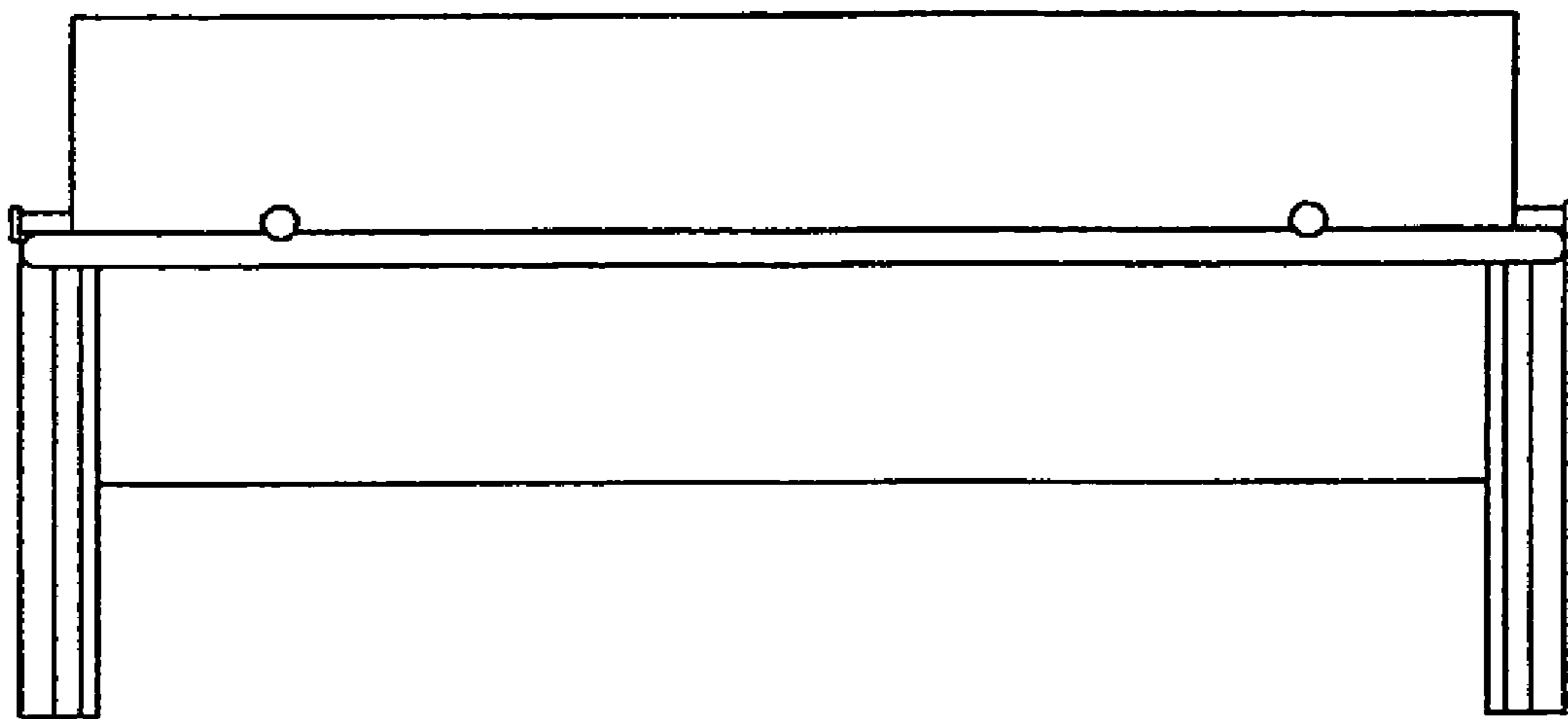

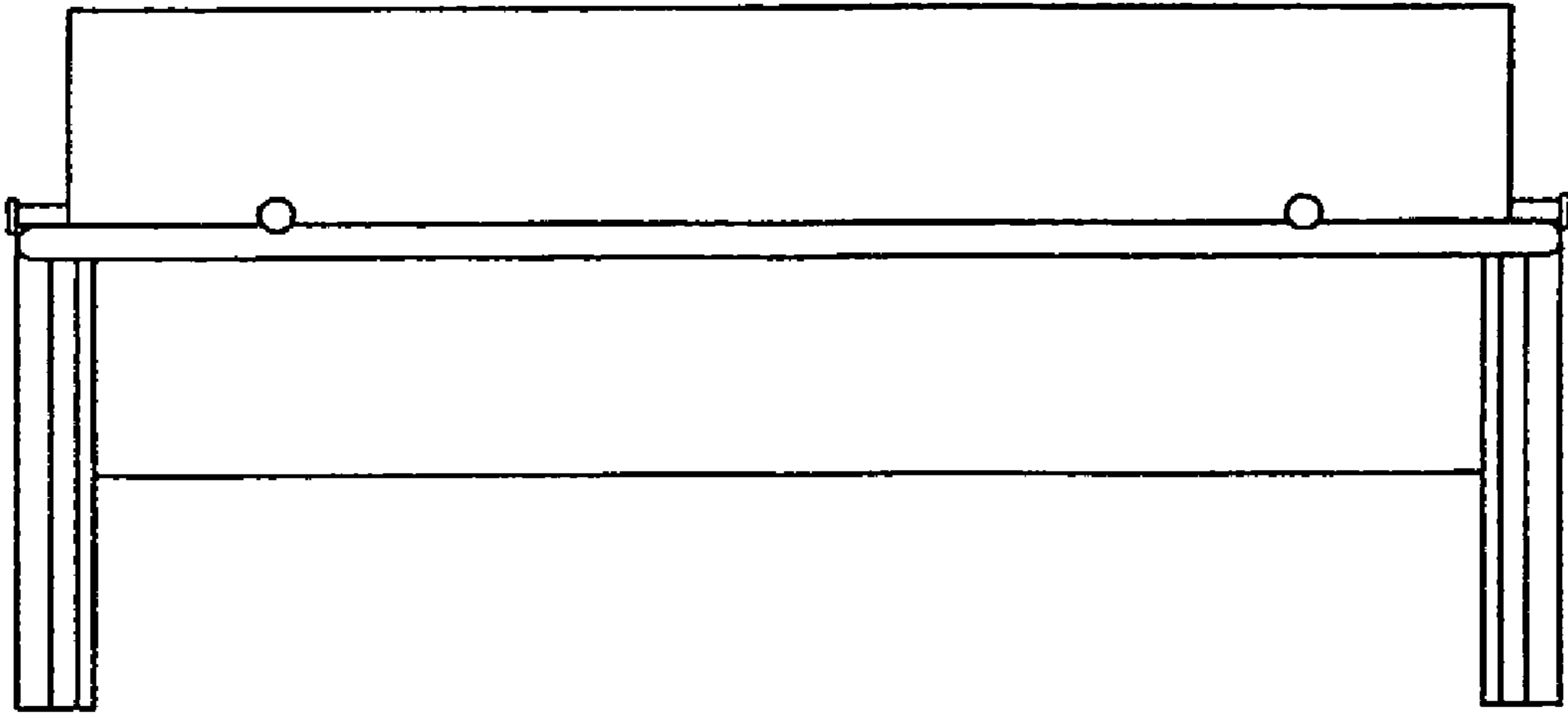

Fig. 1

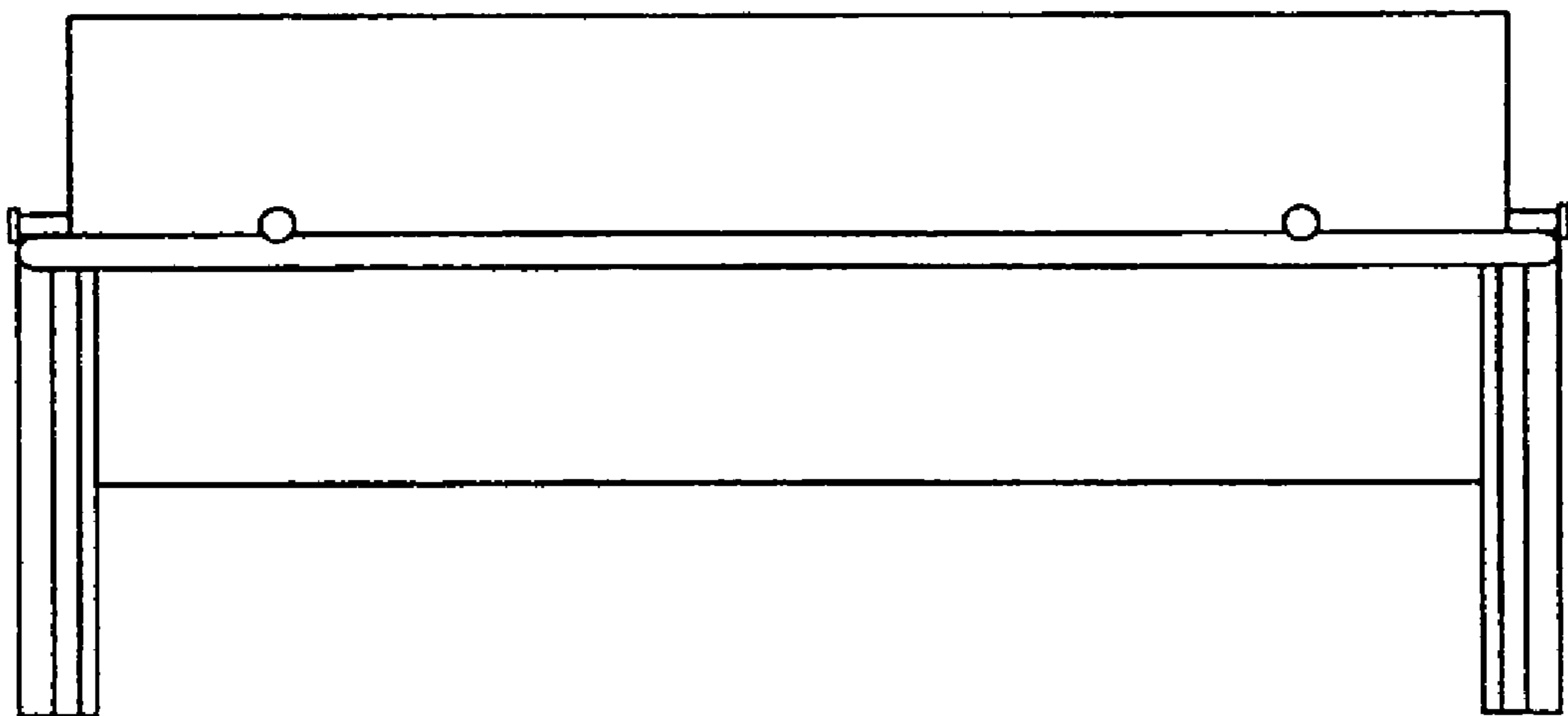

Fig. 2

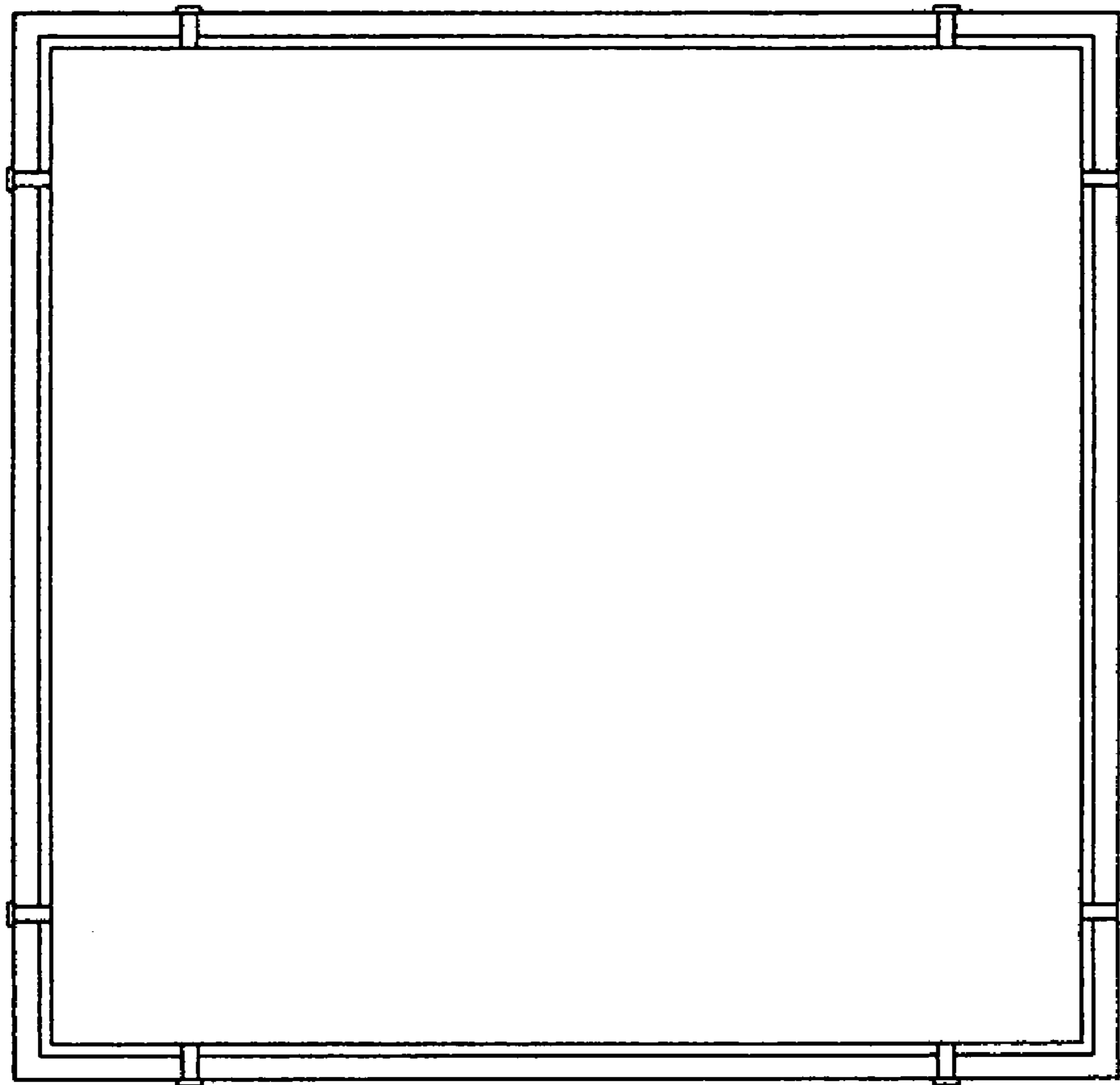

Fig. 3

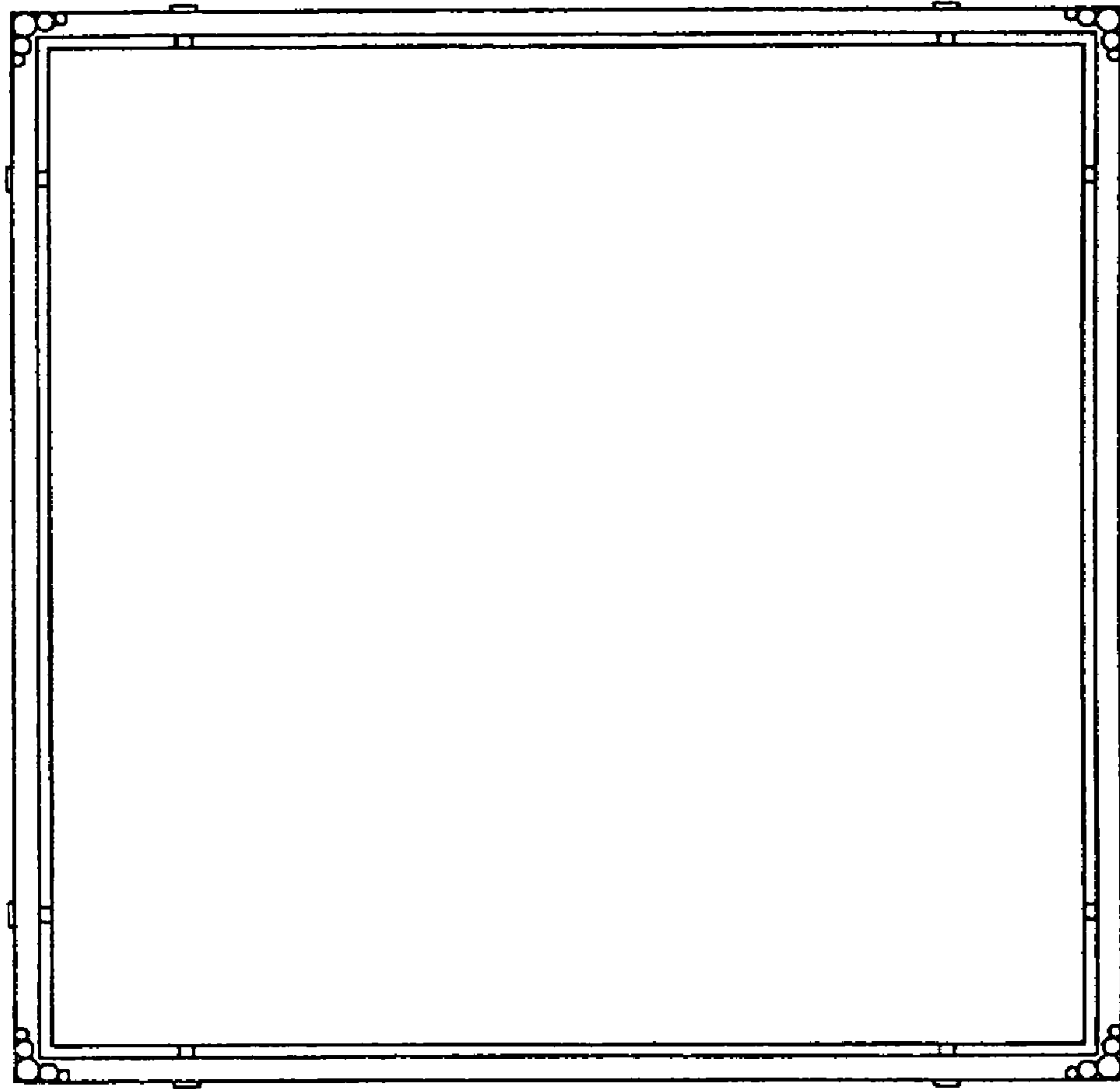

Fig. 4

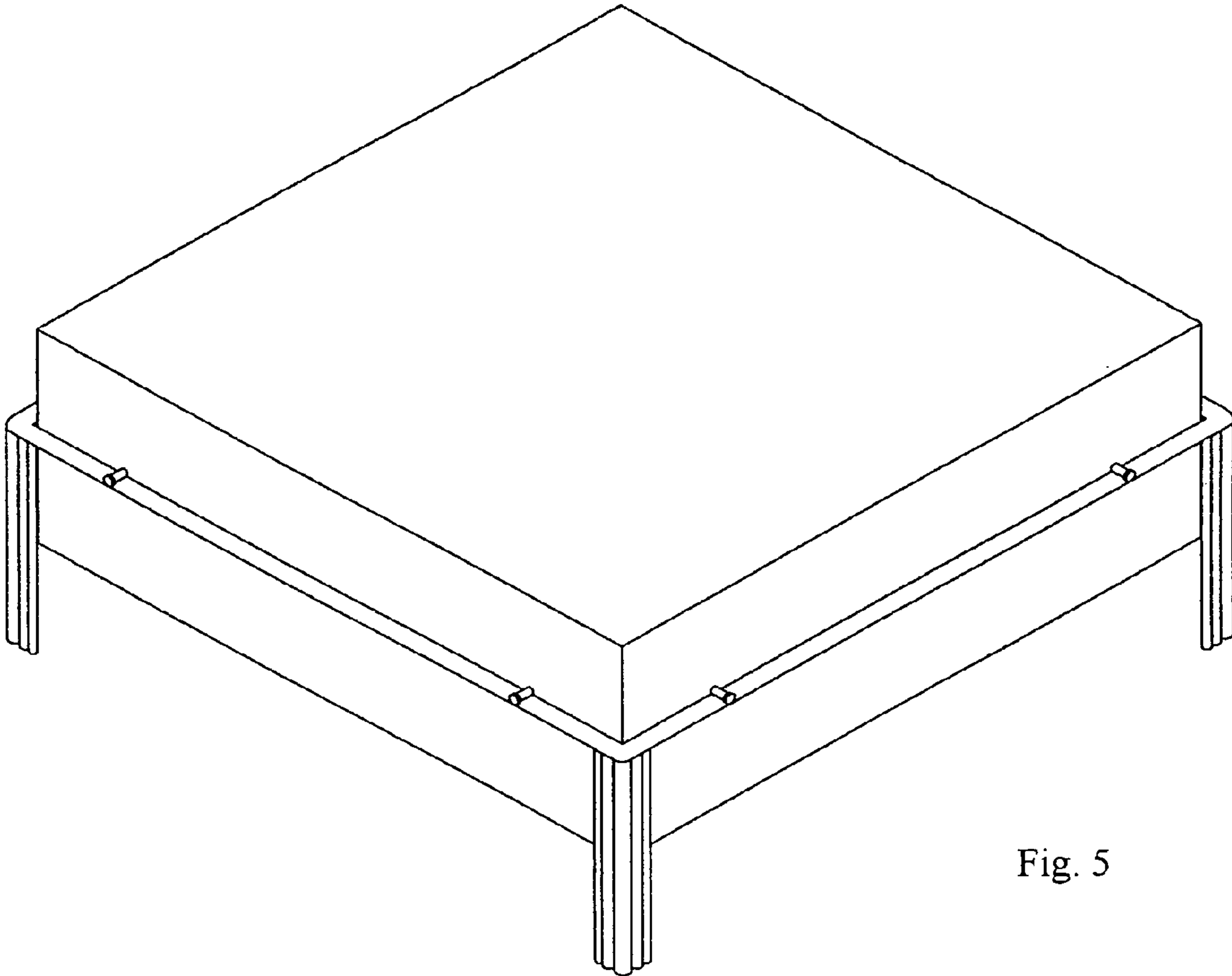

Fig. 5

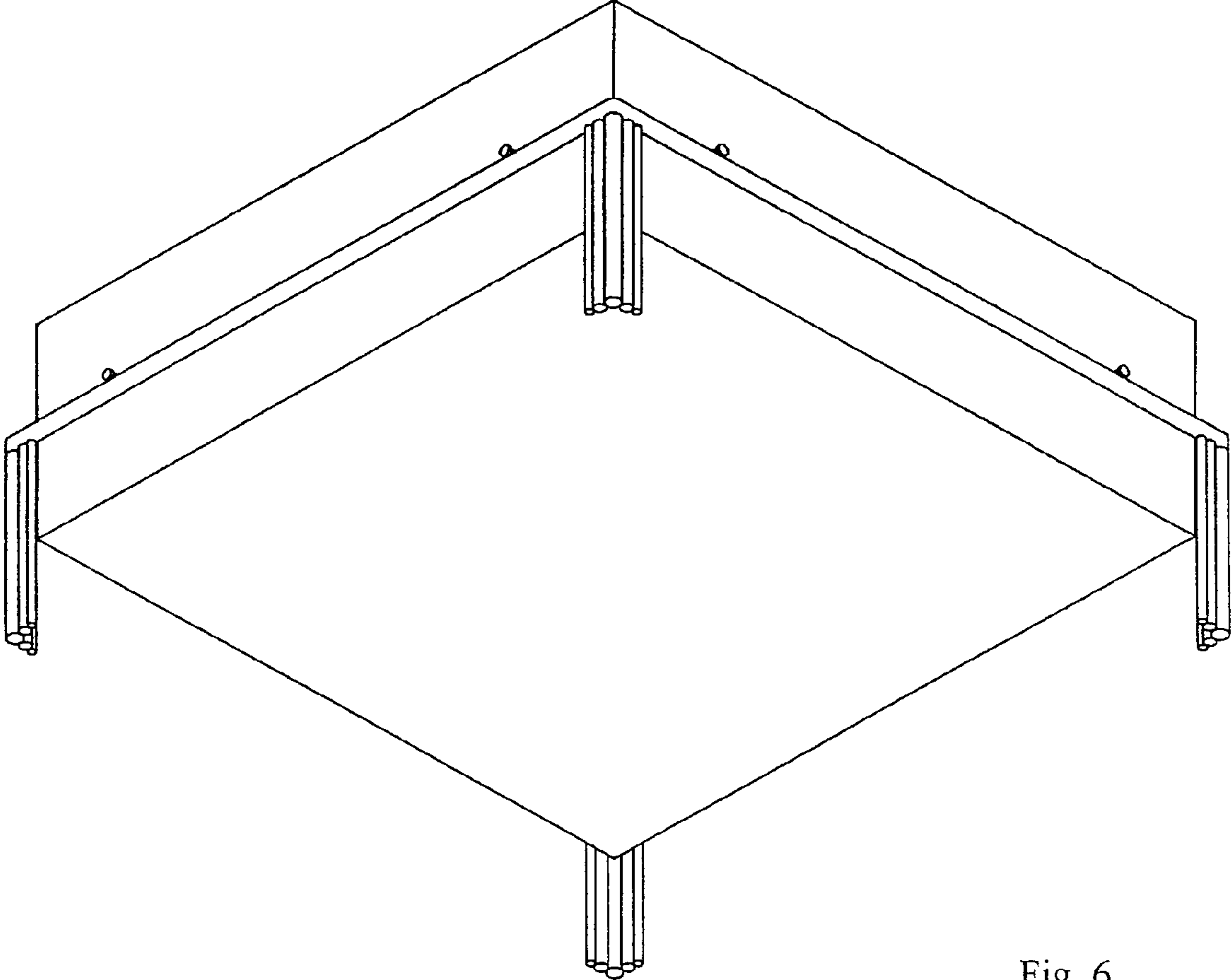

Fig. 6