



US00D549009S

(12) **United States Design Patent**
Lin

(10) **Patent No.:** **US D549,009 S**

(45) **Date of Patent:** **** Aug. 21, 2007**

(54) **COMPUTER DESK**

D506,887 S * 7/2005 McDiarmid D6/480
7,111,564 B2 * 9/2006 Chang 108/155

(75) Inventor: **Yung-Hsiang Lin**, Hsiu Shui Hsiang
(TW)

* cited by examiner

(73) Assignee: **Hae Ing Furniture Co., Ltd**, Hsialuu
Village (TW)

Primary Examiner—Janice E. Seeger

Assistant Examiner—Zenia Bennett

(**) Term: **14 Years**

(74) *Attorney, Agent, or Firm*—Alan Kamrath; Kamrath &
Associates P.A.

(21) Appl. No.: **29/264,681**

(57) **CLAIM**

(22) Filed: **Aug. 15, 2006**

The ornamental design for a computer desk, as shown and
described.

(51) **LOC (8) Cl.** **06-03**

(52) **U.S. Cl.** **D6/480; D6/423**

(58) **Field of Classification Search** D6/422–428,
D6/480, 484, 485, 487; 312/194–196, 223.1,
312/223.2

See application file for complete search history.

DESCRIPTION

FIG. 1 is a perspective view of a computer desk showing my
design;

FIG. 2 is a front elevational view thereof;

FIG. 3 is a rear elevational view thereof;

FIG. 4 is a left side elevational view thereof;

FIG. 5 is a right side elevational view thereof;

FIG. 6 is a top plan view thereof; and,

FIG. 7 is a bottom plan view thereof.

(56) **References Cited**

U.S. PATENT DOCUMENTS

D278,770 S * 5/1985 Koguma D6/423
D373,262 S * 9/1996 Luong et al. D6/423
D430,979 S * 9/2000 Brandenburg D6/426
D469,269 S * 1/2003 Tzeng D6/423
D471,030 S * 3/2003 Chang D6/423

1 Claim, 4 Drawing Sheets

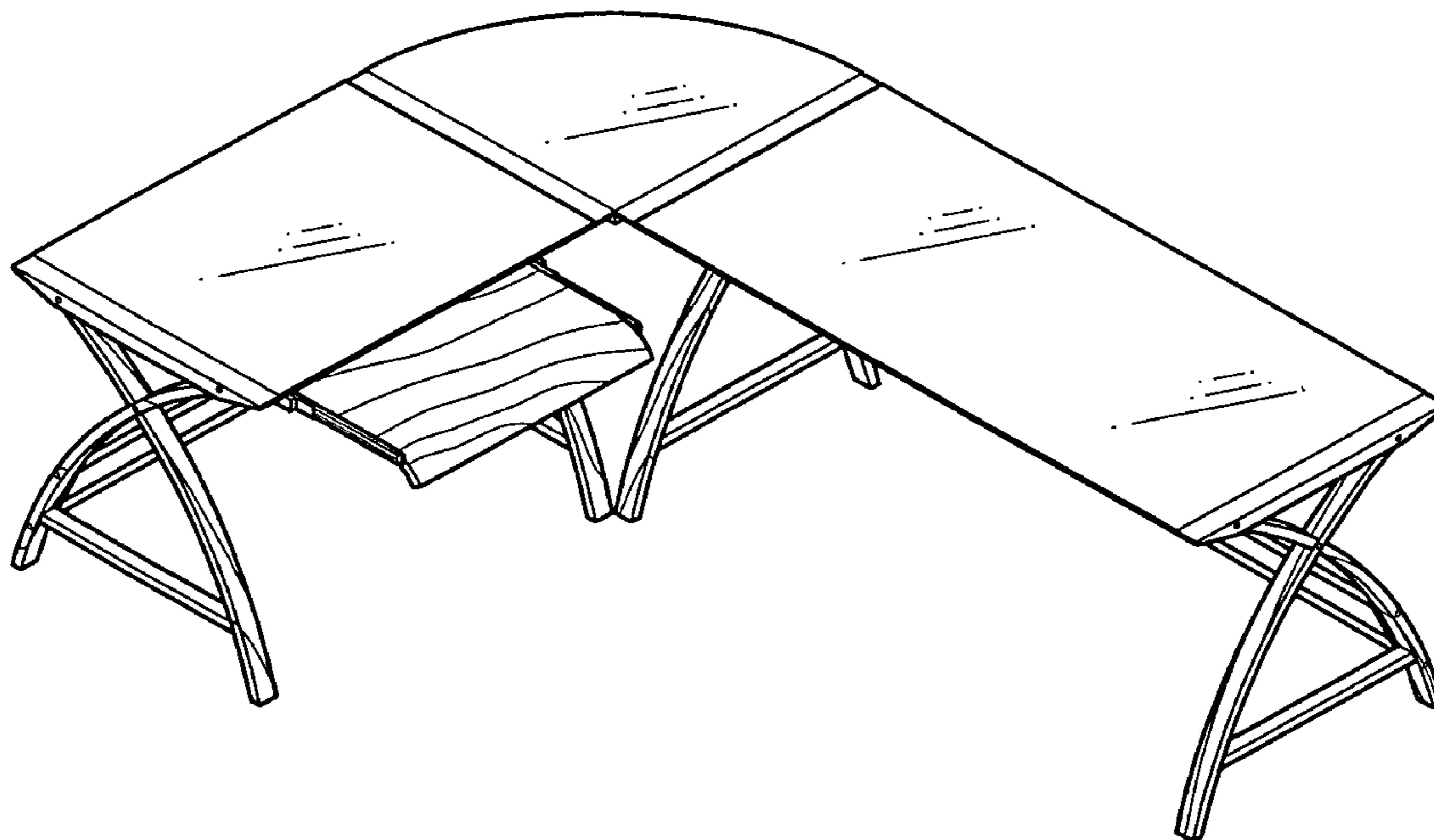

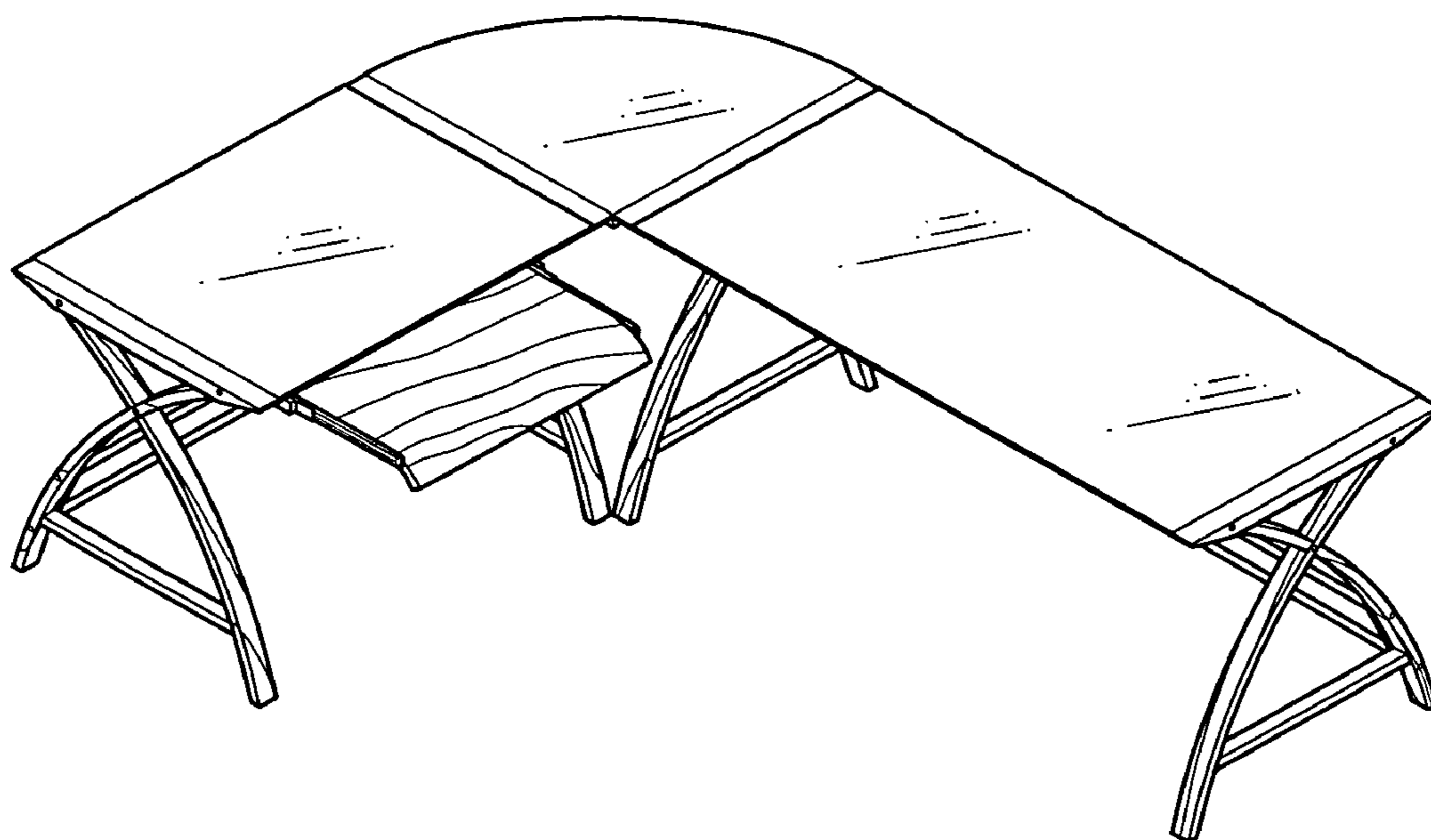

FIG. 1

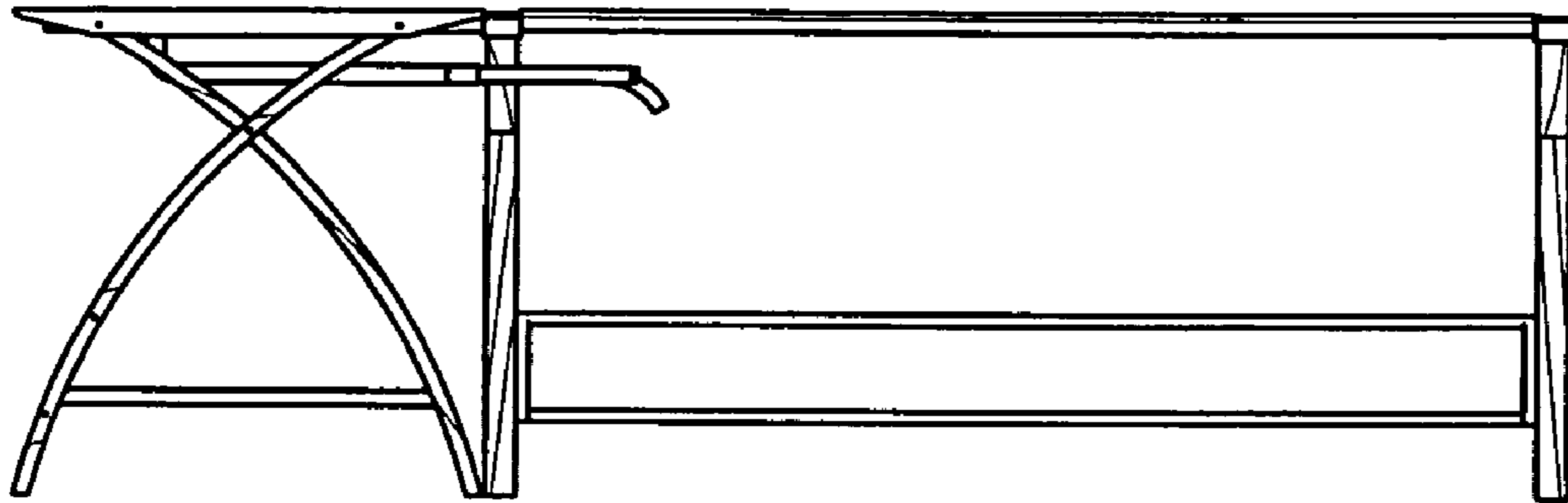

FIG. 2

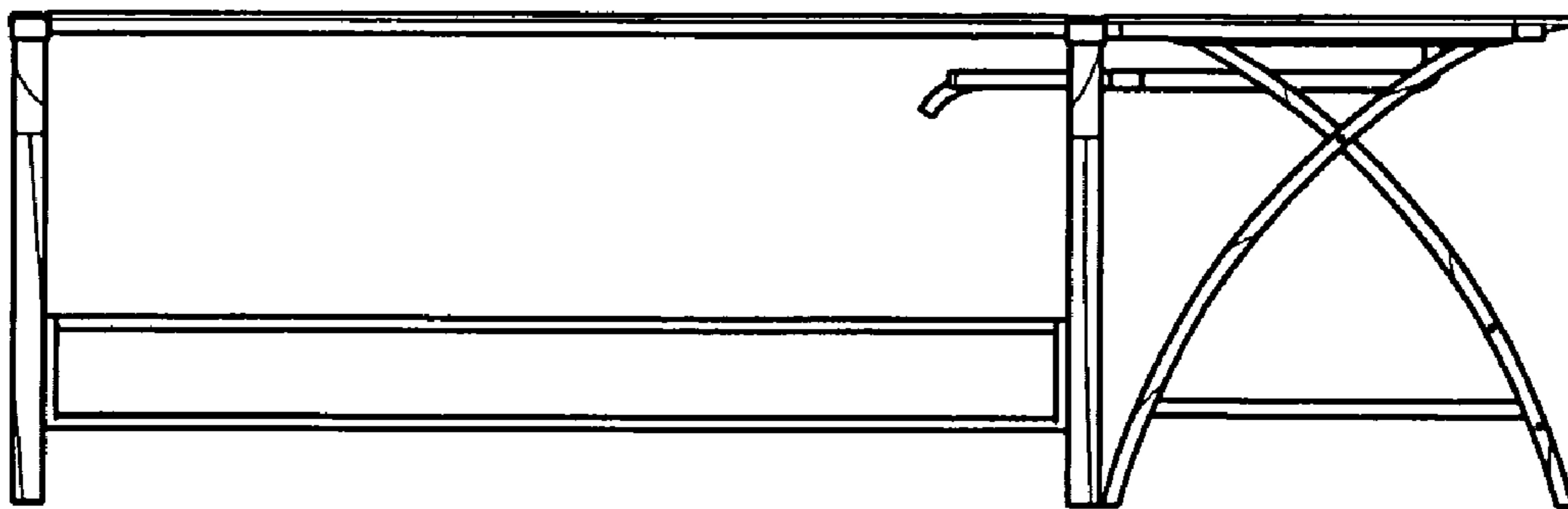

FIG. 3

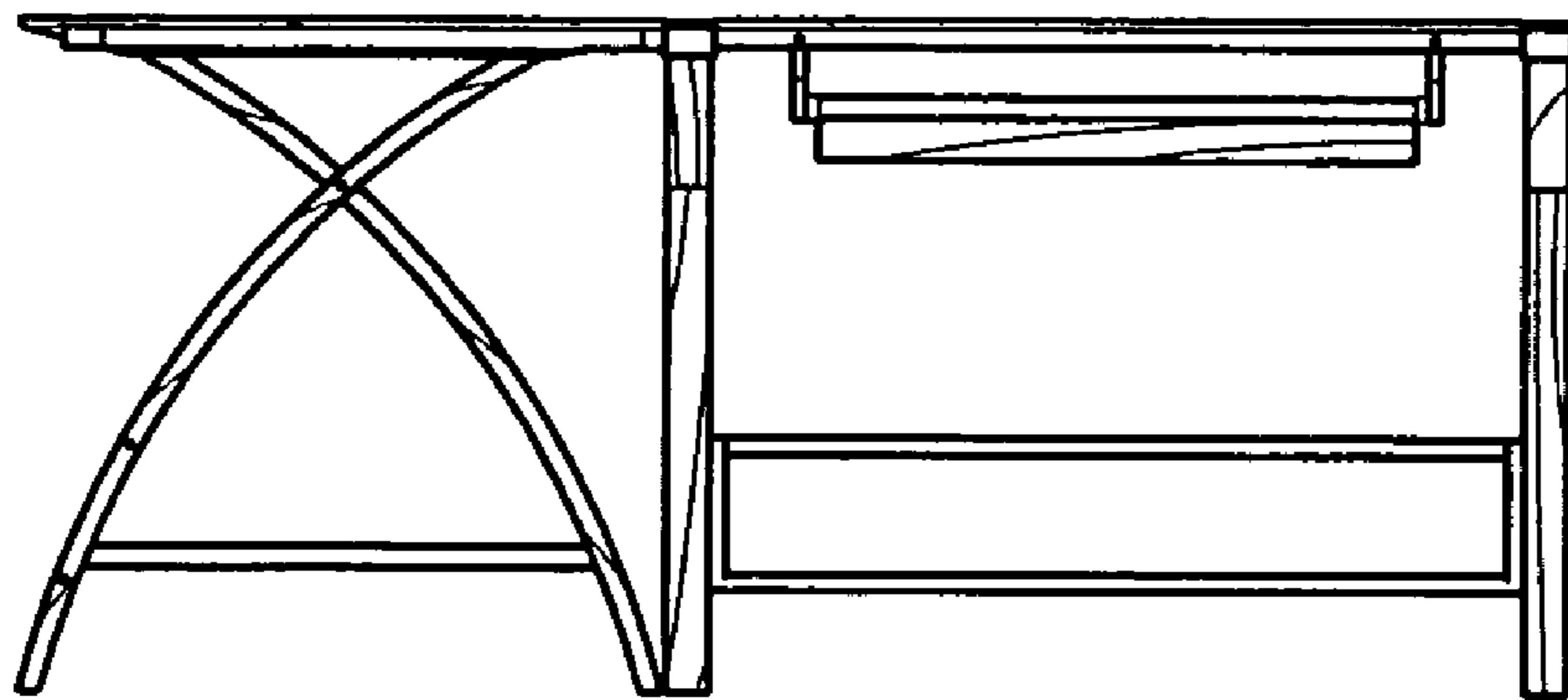

FIG. 4

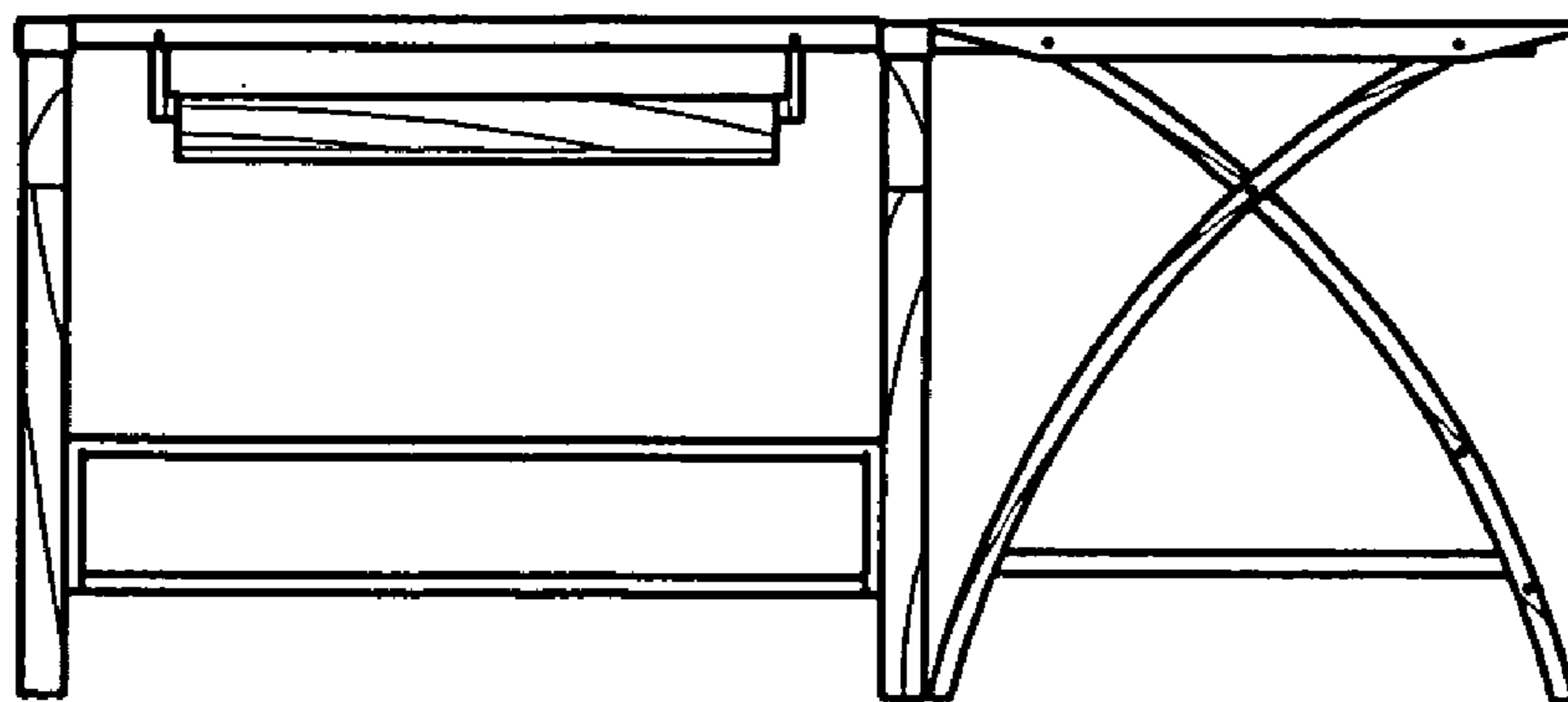

FIG. 5

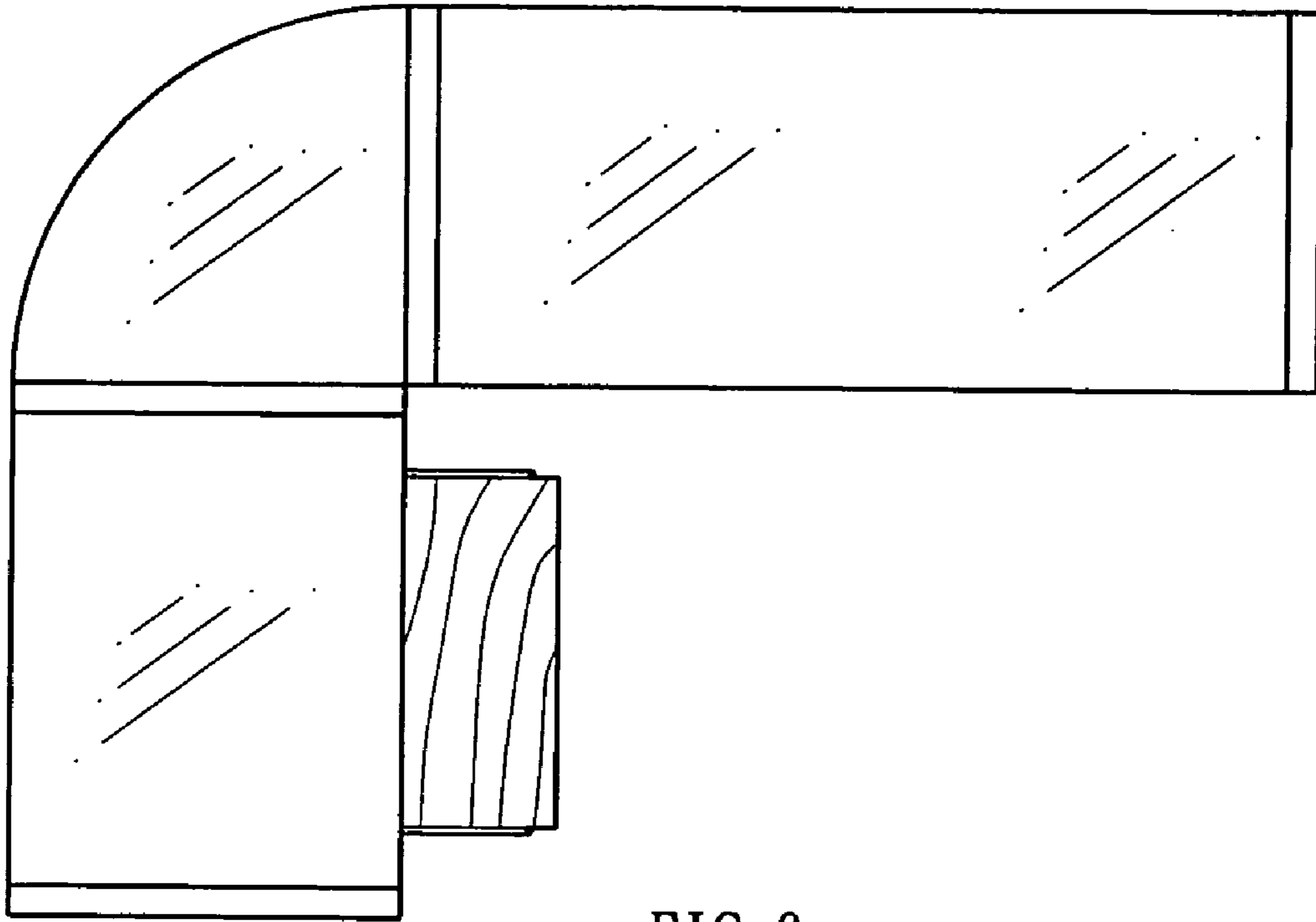

FIG. 6

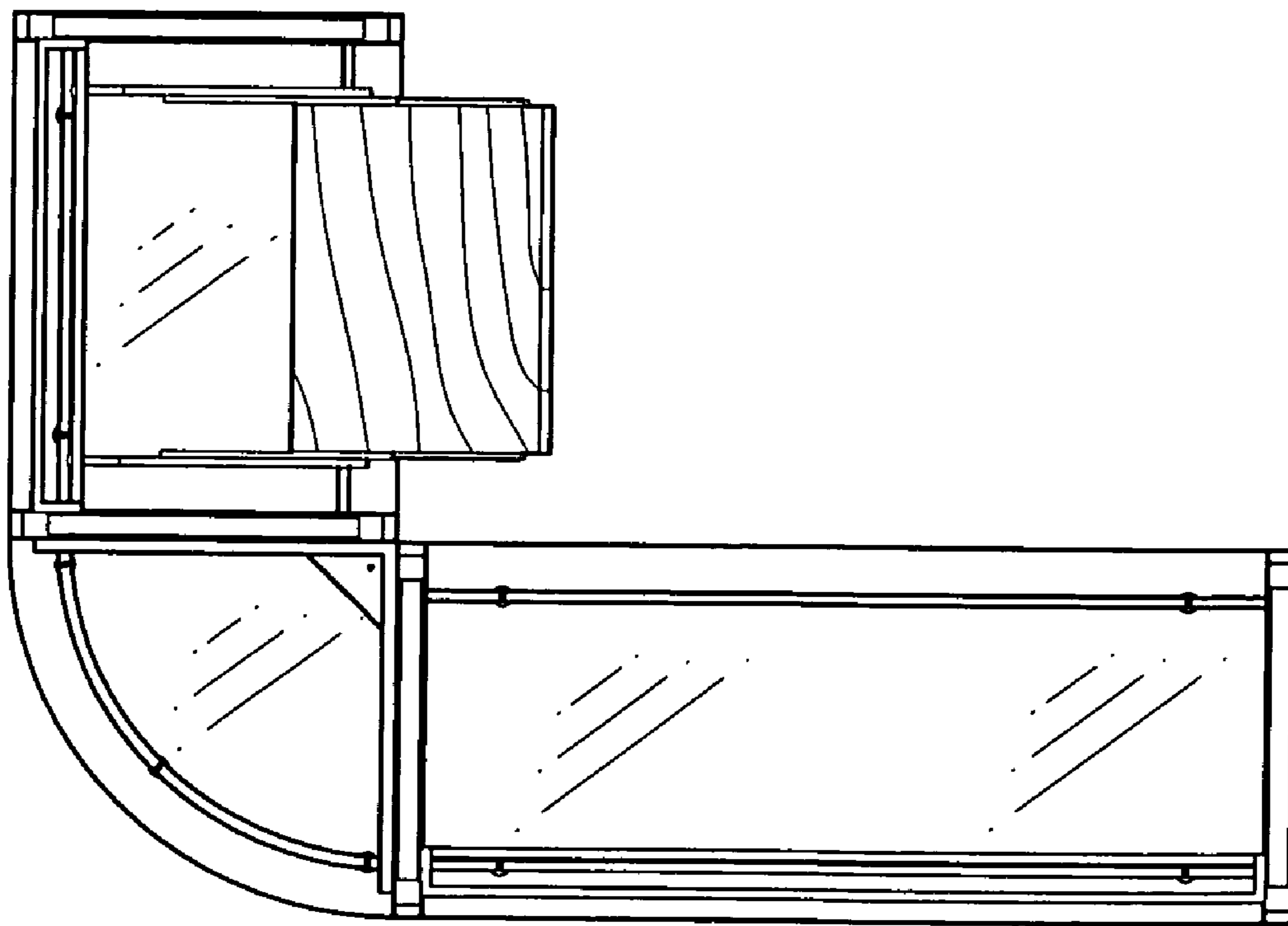

FIG. 7