

US00D548893S

(12) **United States Design Patent** (10) **Patent No.:** **US D548,893 S**
Hedge et al. (45) **Date of Patent:** **** Aug. 14, 2007**

(54) **FACE PROTECTOR**

(75) Inventors: **Clint Hedge**, Chesterville (CA); **Justin Myles**, Carlsbad Springs (CA); **Daniel Crossman**, Kanata (CA)

(73) Assignee: **Med-Eng Systems Inc.** (CA)

(**) Term: **14 Years**

(21) Appl. No.: **29/246,106**

(22) Filed: **Feb. 16, 2006**

(51) **LOC (8) Cl.** **29-02**

(52) **U.S. Cl.** **D29/122**

(58) **Field of Classification Search** D29/102–108,
D29/122; 2/410–411, 414, 416–419, 421–425,
2/205, 6.1–6.7, 9, 173, 5
See application file for complete search history.

(56) **References Cited**

U.S. PATENT DOCUMENTS

3,216,023	A	*	11/1965	Morgan	2/9
D229,127	S	*	11/1973	Franklin	D29/108
3,886,596	A	*	6/1975	Franklin et al.	2/9
D243,127	S	*	1/1977	Farquharson	D29/108
4,042,974	A	*	8/1977	Morgan et al.	2/9
D246,012	S	*	10/1977	Minette	D29/108
D267,128	S	*	12/1982	Pearce	D29/108
4,374,301	A		2/1983	Frieder, Jr.		
4,713,844	A		12/1987	Westgate		
5,078,130	A		1/1992	Van Oosten		
5,522,091	A		6/1996	Rudolf		
D471,675	S	*	3/2003	Ikeda	D29/122
D488,264	S	*	4/2004	Masterson	D29/106
D535,061	S	*	1/2007	Evans et al.	D29/122

OTHER PUBLICATIONS

Crye Associates, printout of page found at website“www.cryeas-
sociates.com/09.html”, one page, printed Mar. 7, 2006.

Gentex Helmet Systems, printout of pages found at website
“gentexcorp.com/HelmetSystems/MFS.htm”, two pages, printed
Mar. 7, 2006.

* cited by examiner

Primary Examiner—Ruth McInroy

(74) *Attorney, Agent, or Firm*—Barnes & Thornburg LLP

(57) **CLAIM**

The ornamental design for a face protector, as shown and
described.

DESCRIPTION

FIG. 1 shows a front and left-side perspective view of the
face protector embodying the design;

FIG. 2 shows a front and right-side perspective view thereof;

FIG. 3 shows a front view thereof;

FIG. 4 shows a right-side view thereof;

FIG. 5 shows a rear view thereof;

FIG. 6 shows a left-side view thereof;

FIG. 7 shows a top-view thereof;

FIG. 8 shows a bottom view thereof;

FIG. 9 shows a front and left-side perspective view thereof;

FIG. 10 shows a front and right-side perspective view
thereof;

FIG. 11 shows a front view thereof;

FIG. 12 shows a right-side view thereof;

FIG. 13 shows a rear view thereof;

FIG. 14 shows a left-side view thereof;

FIG. 15 shows a top-view thereof; and,

FIG. 16 shows a bottom view thereof.

Features shown in broken lines illustrate the environment of
the face protector and form no part of the design as claimed.

1 Claim, 16 Drawing Sheets

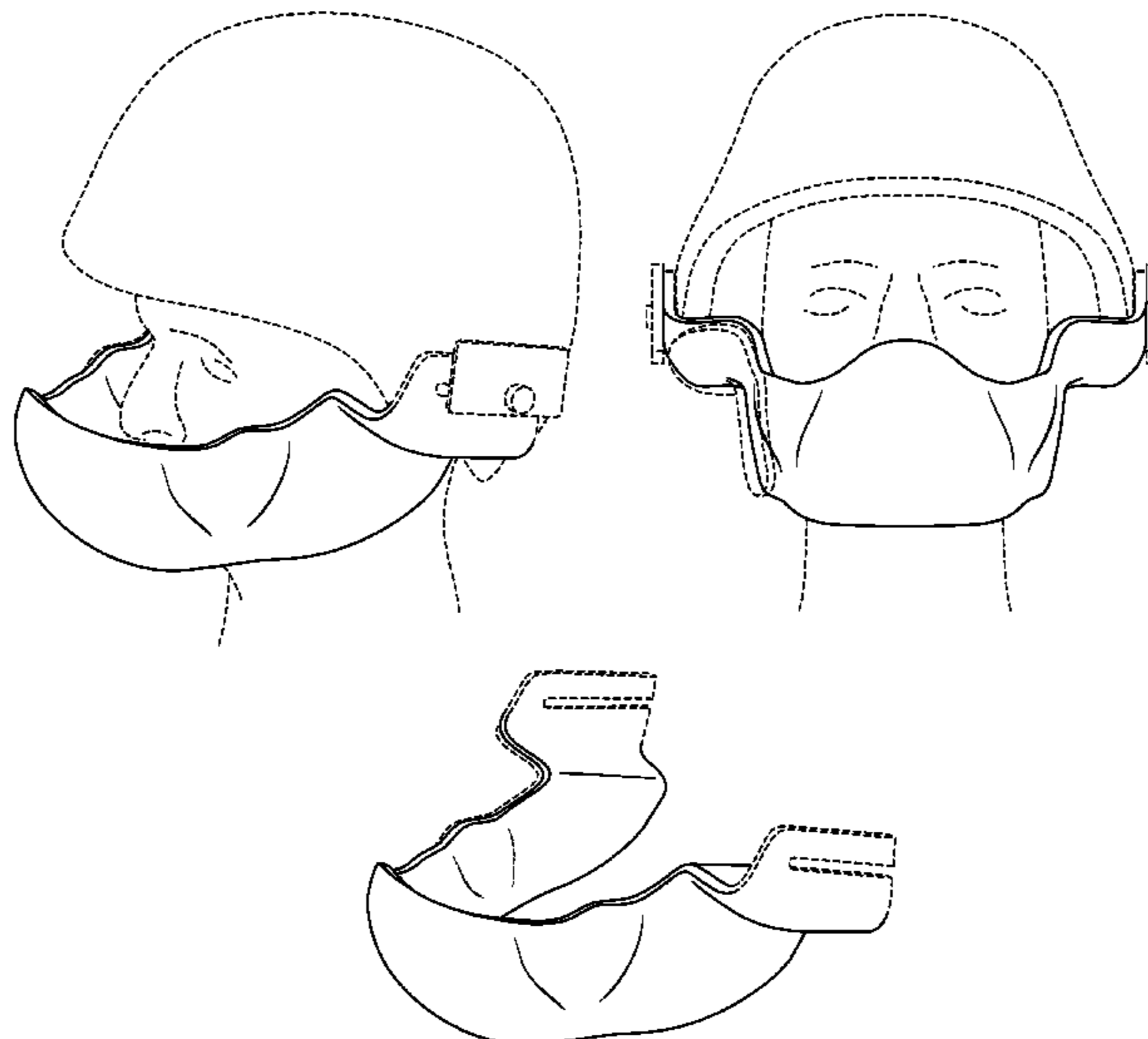

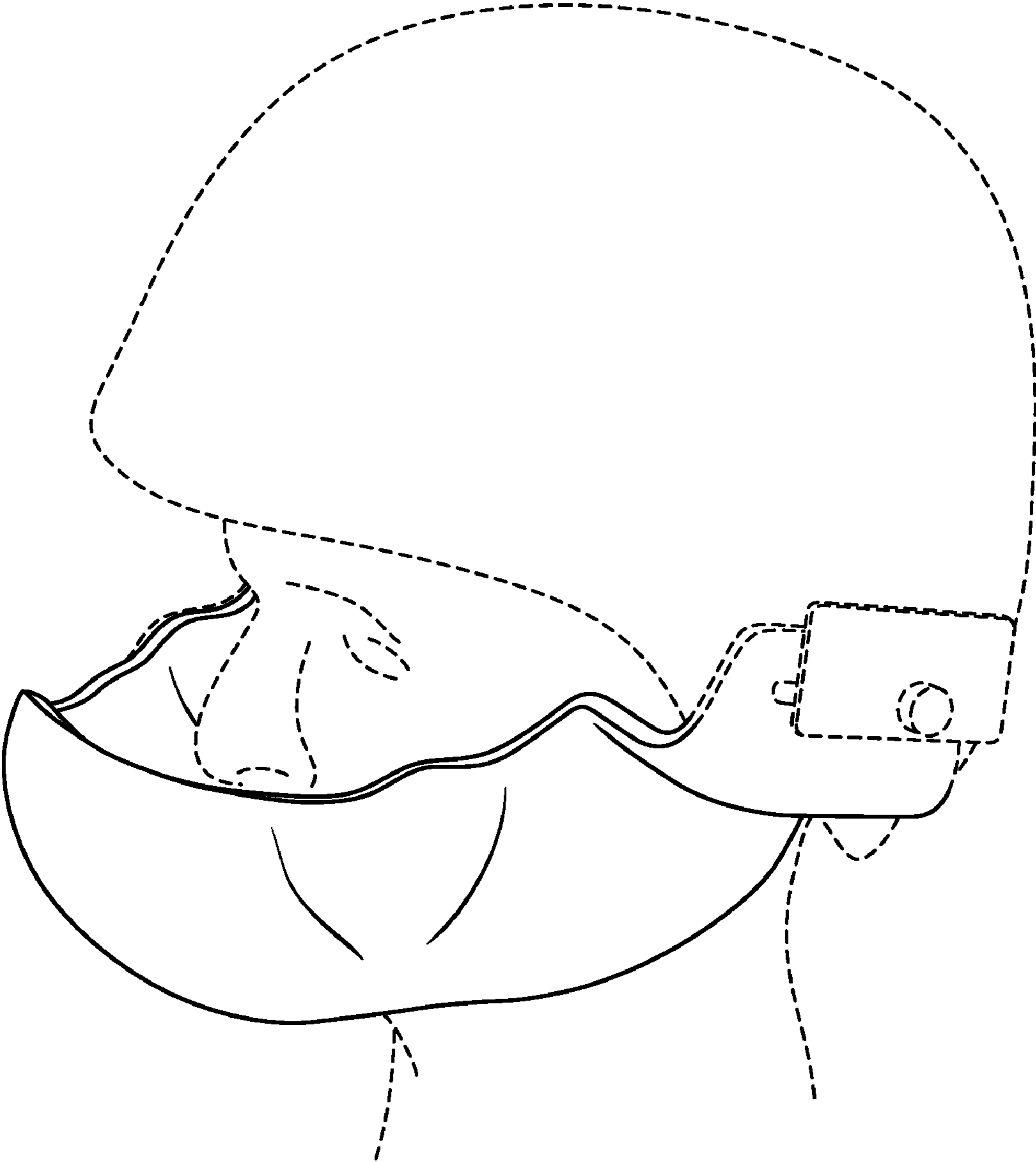

FIG. 1

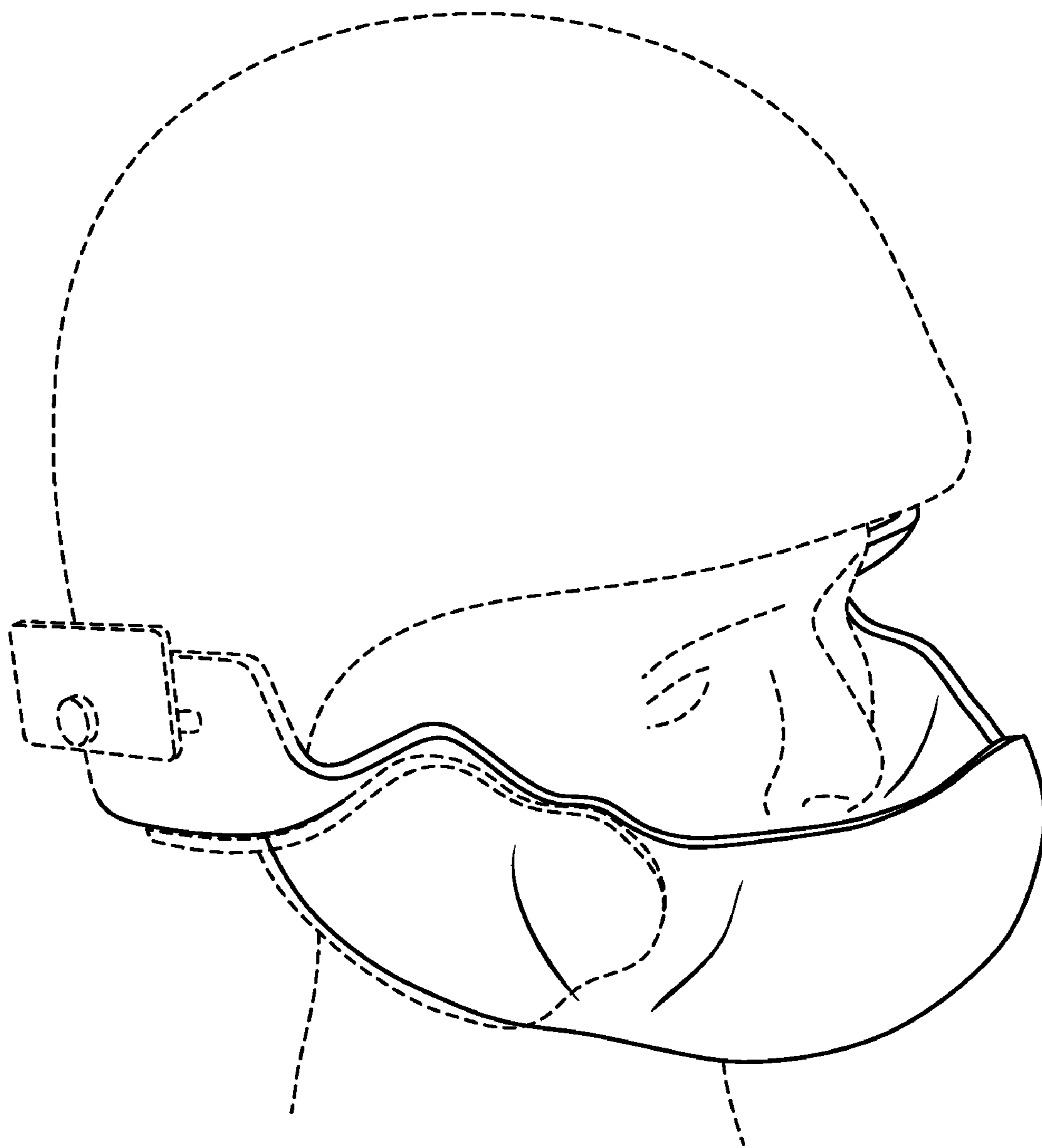

FIG. 2

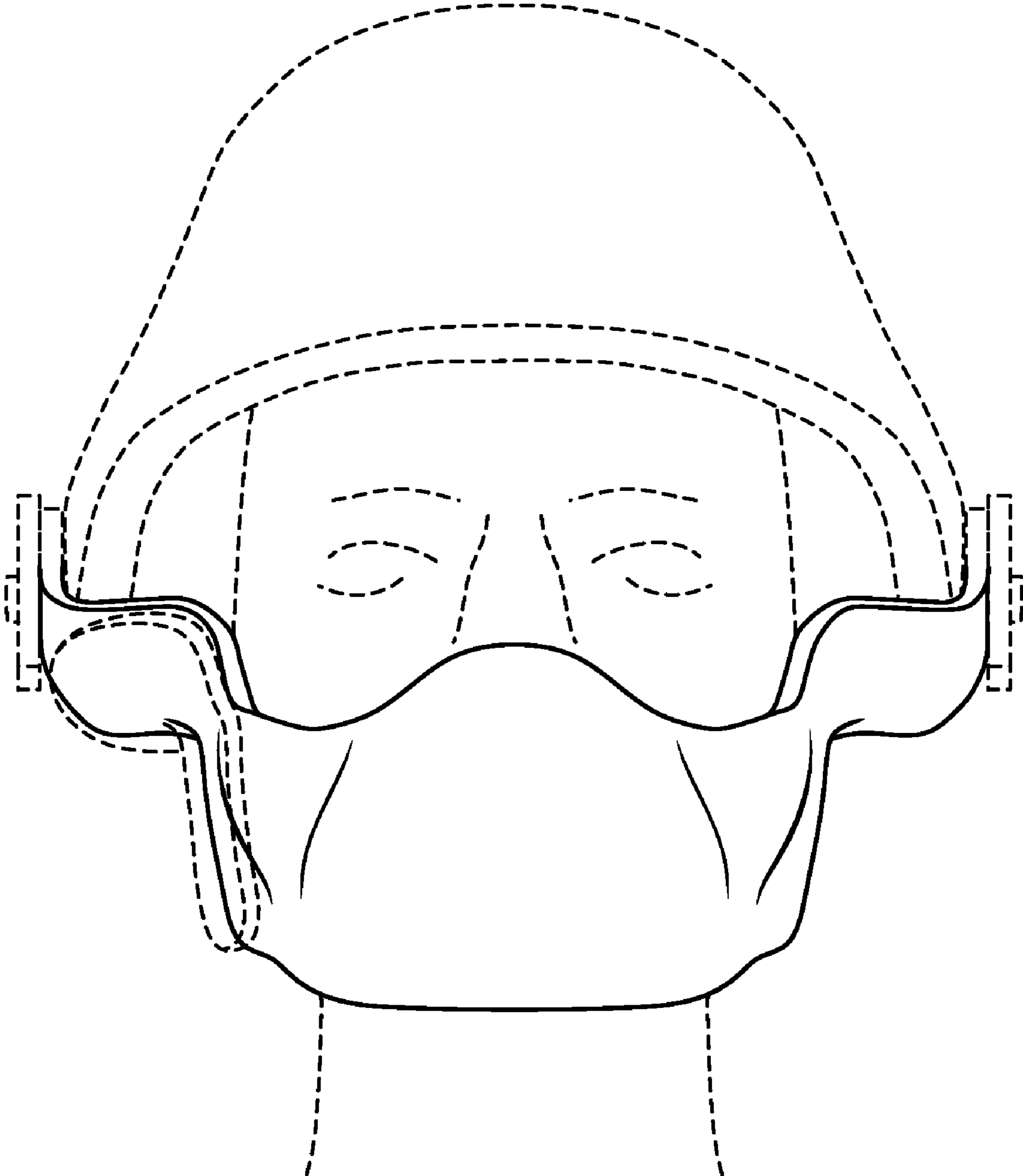

FIG. 3

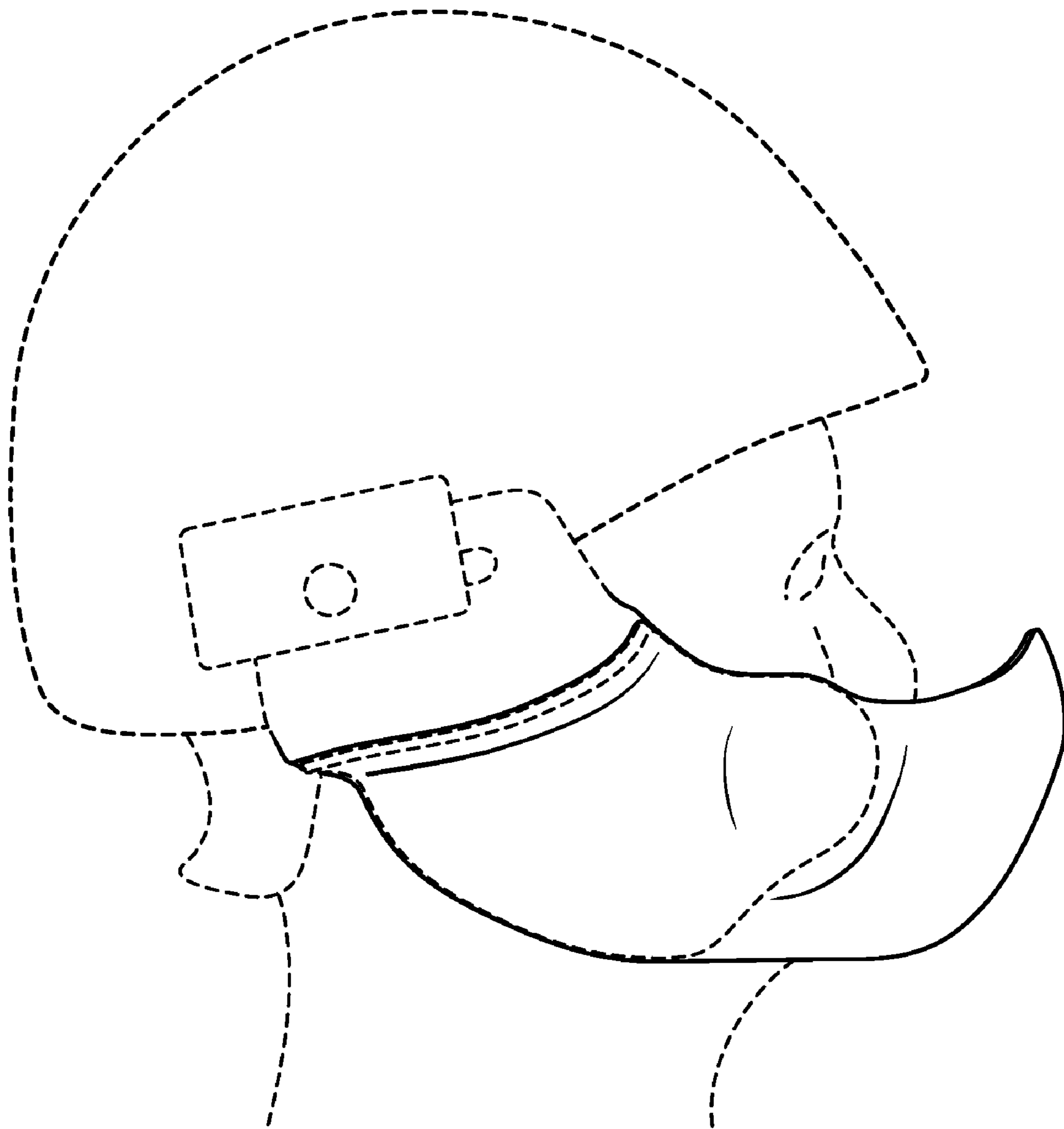

FIG. 4

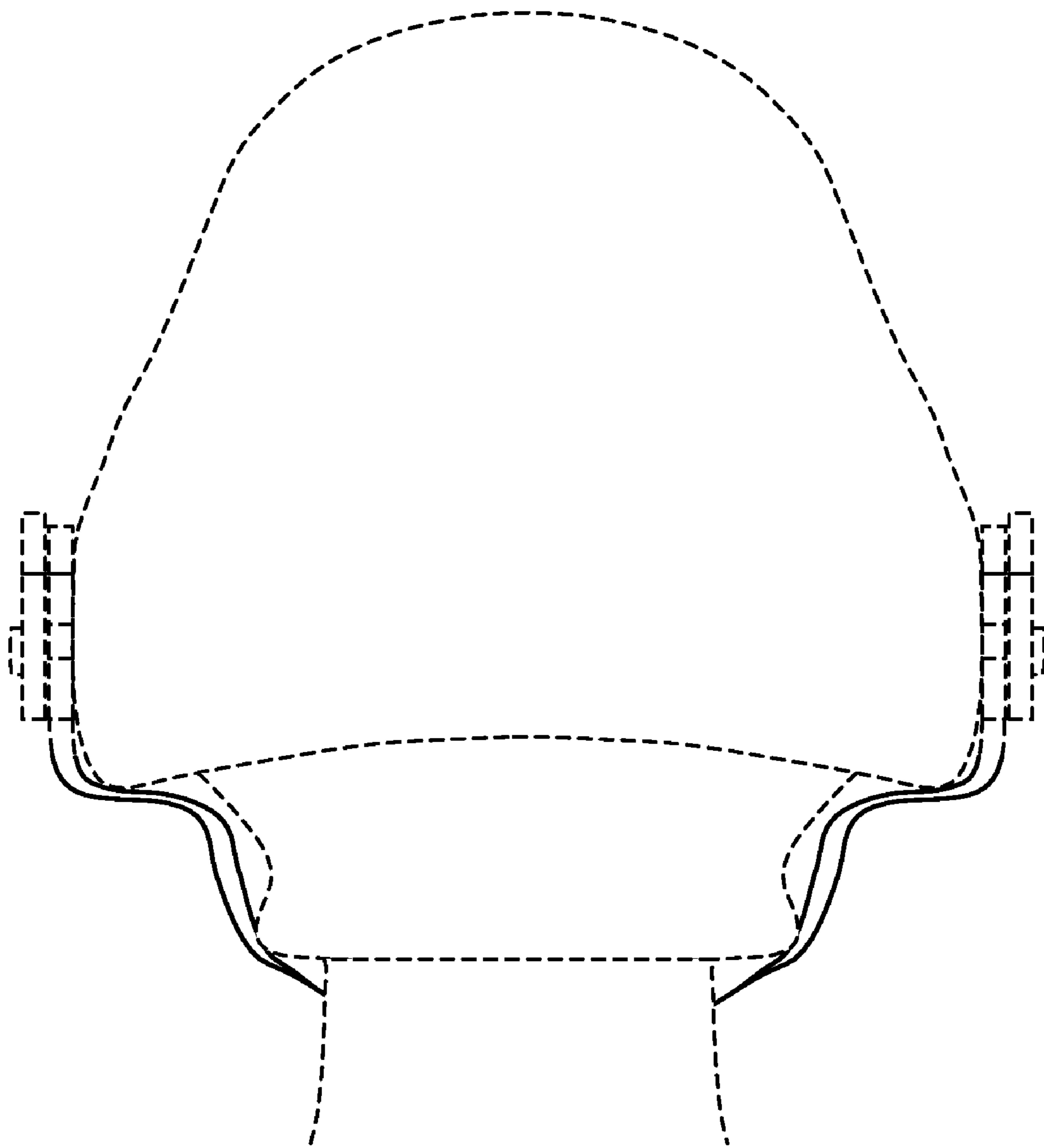

FIG. 5

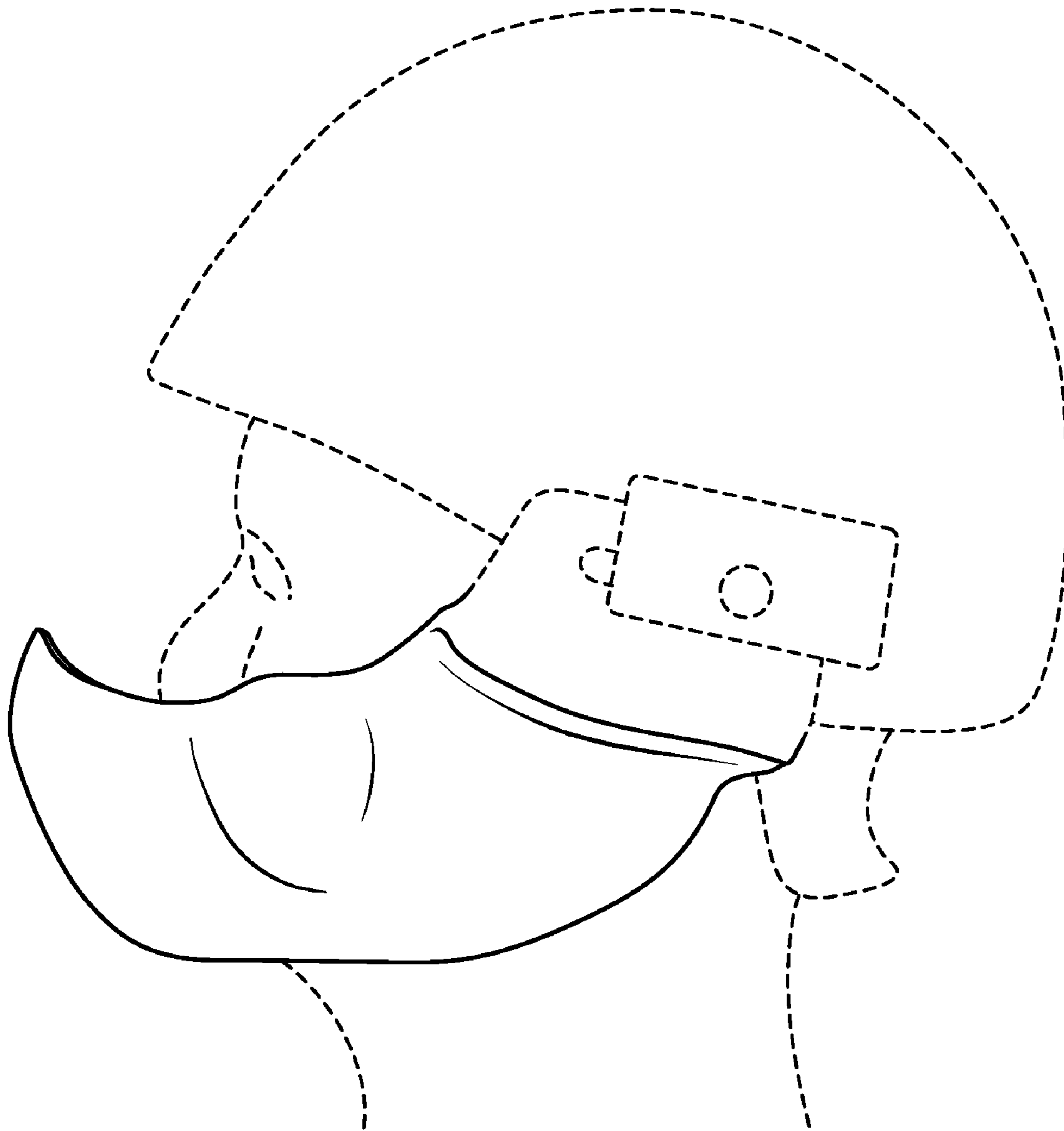

FIG. 6

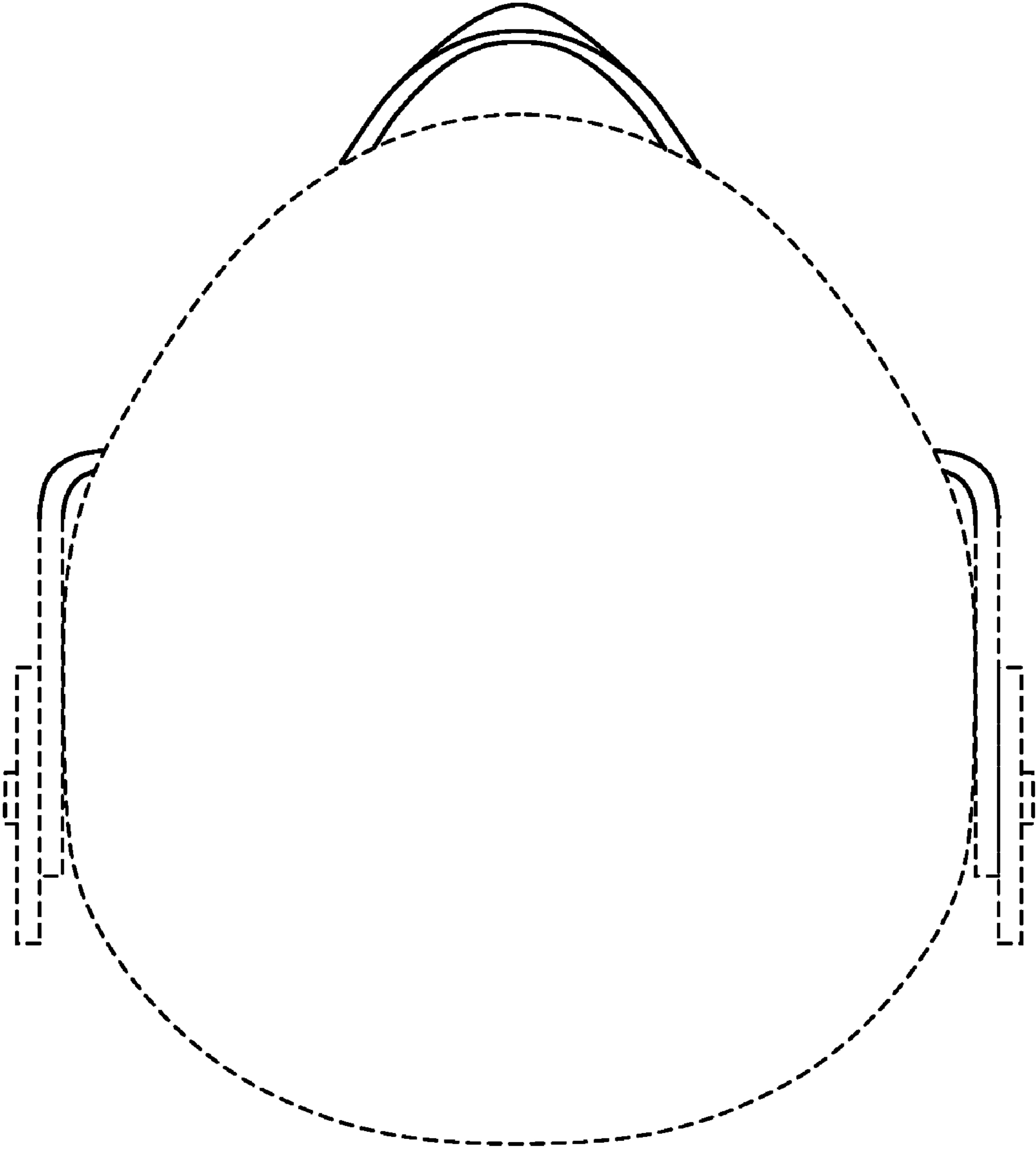

FIG. 7

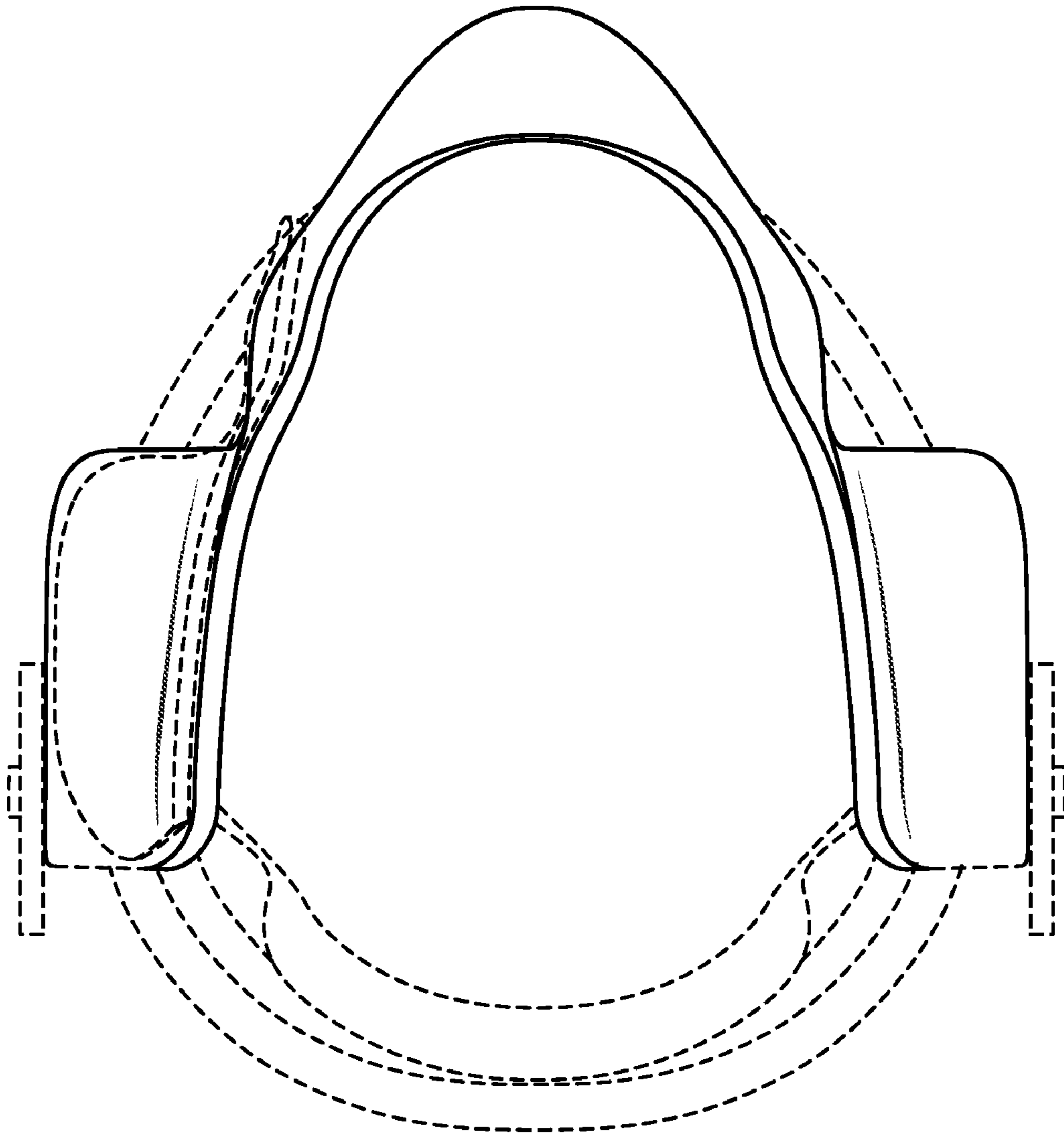

FIG. 8

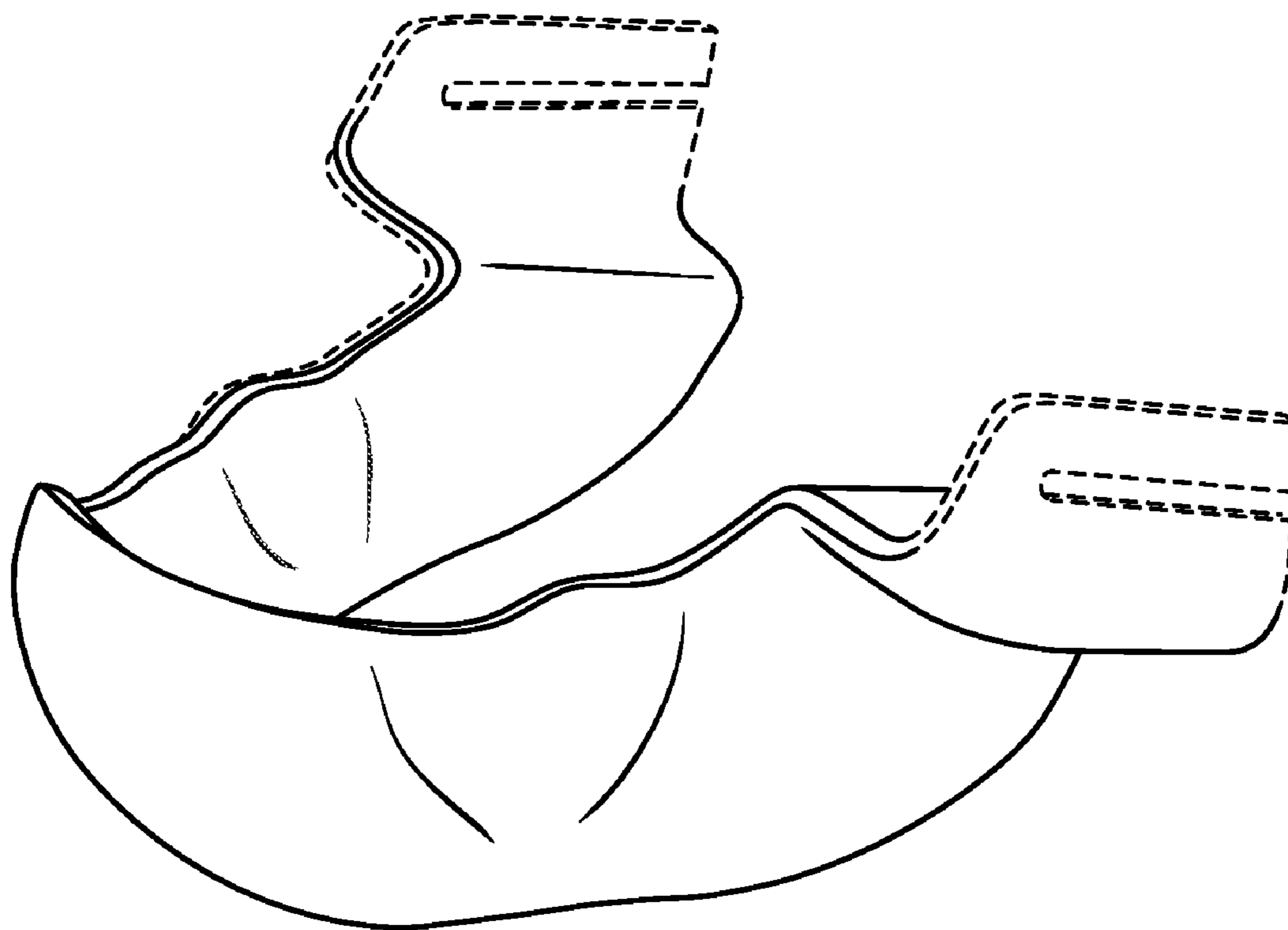

FIG. 9

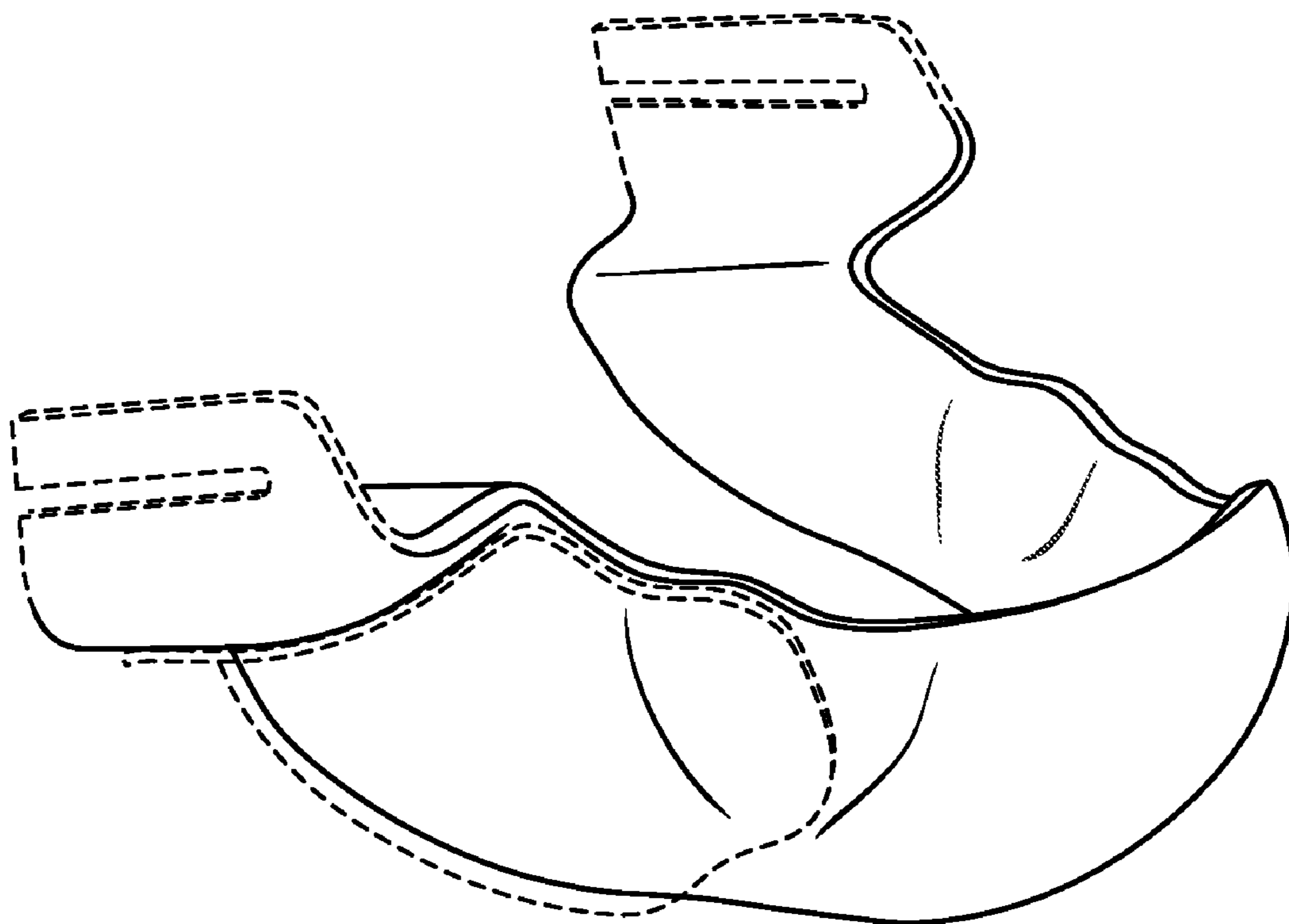

FIG. 10

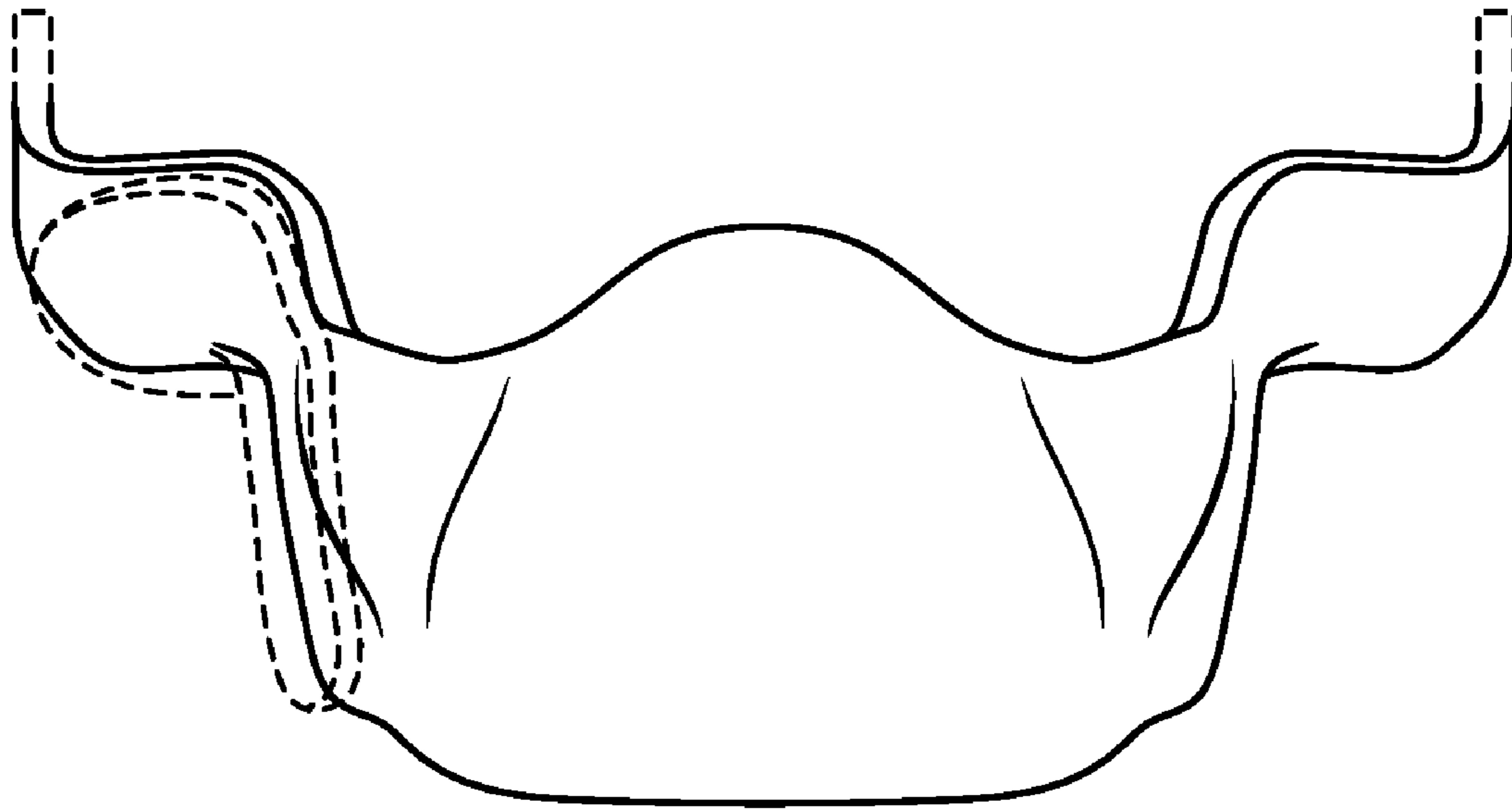

FIG. 11

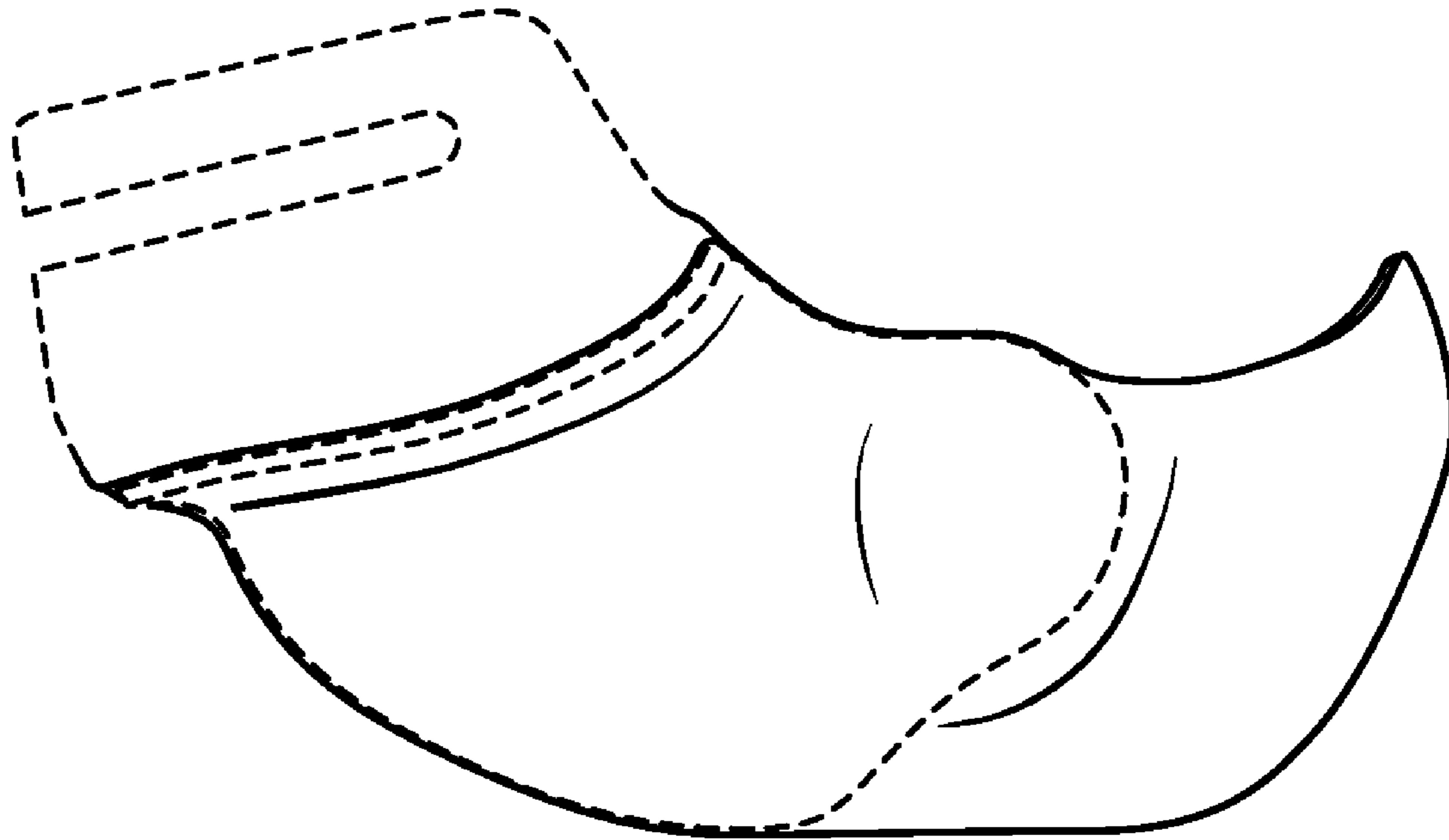

FIG. 12

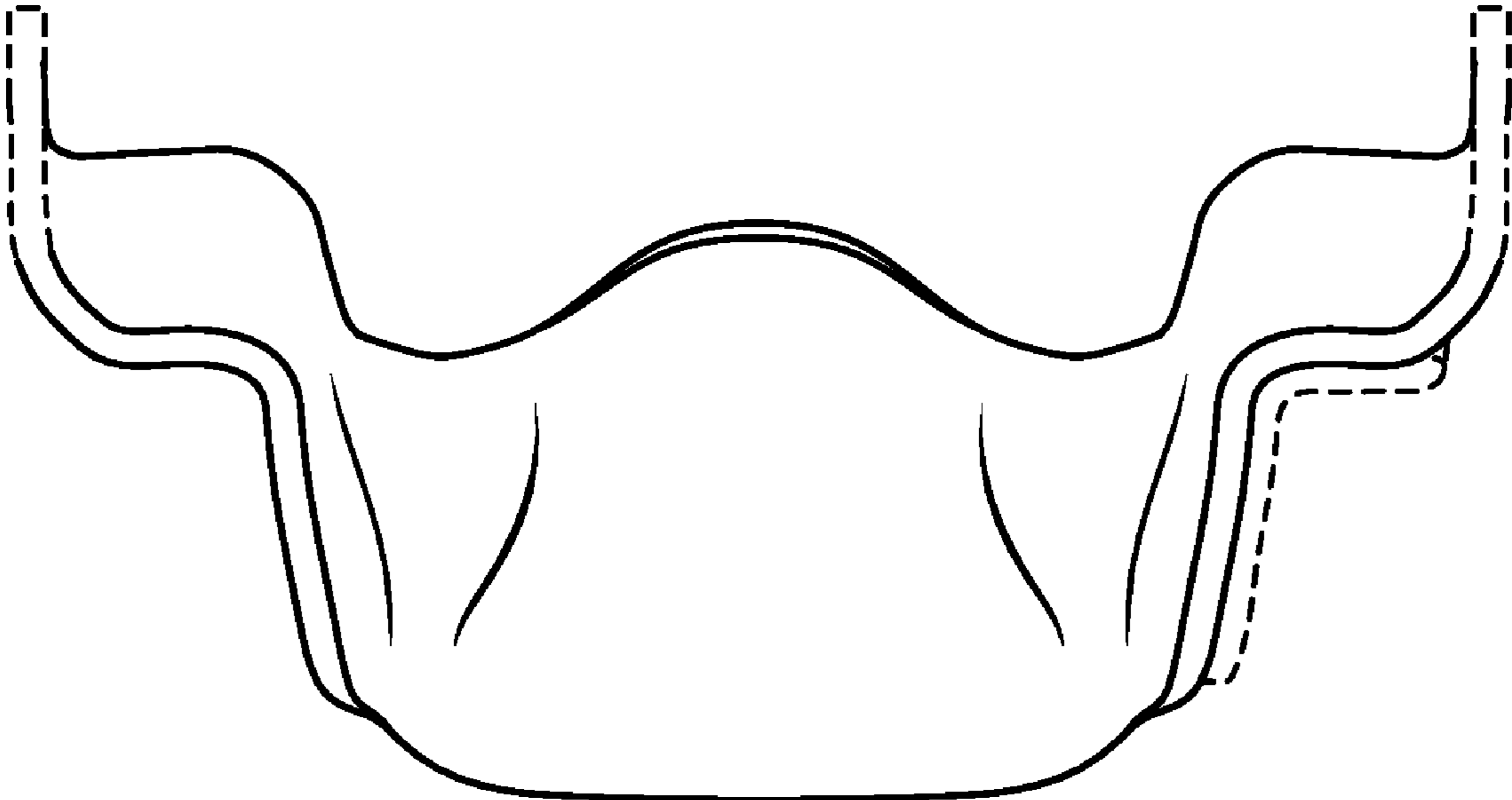

FIG. 13

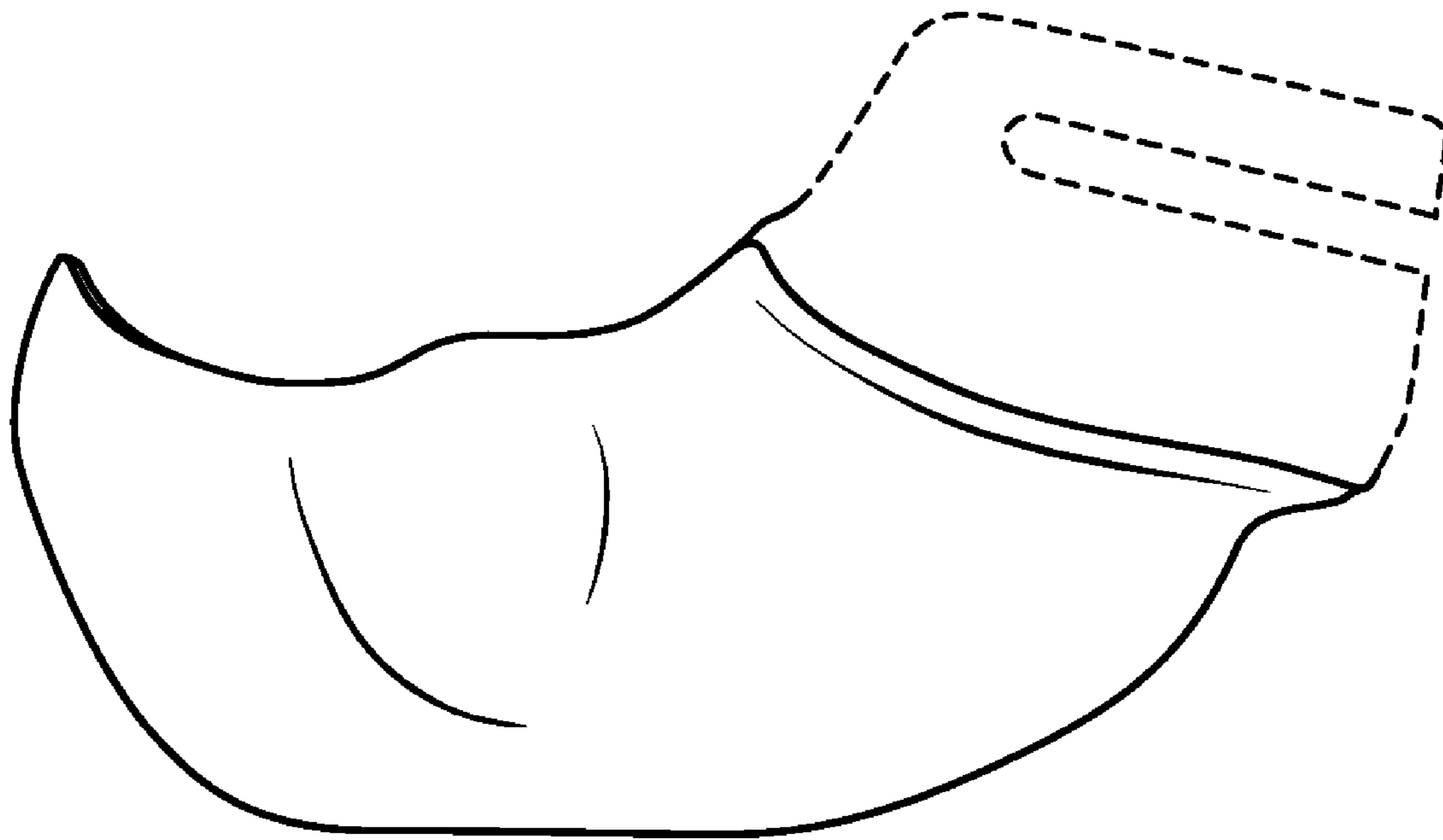

FIG. 14

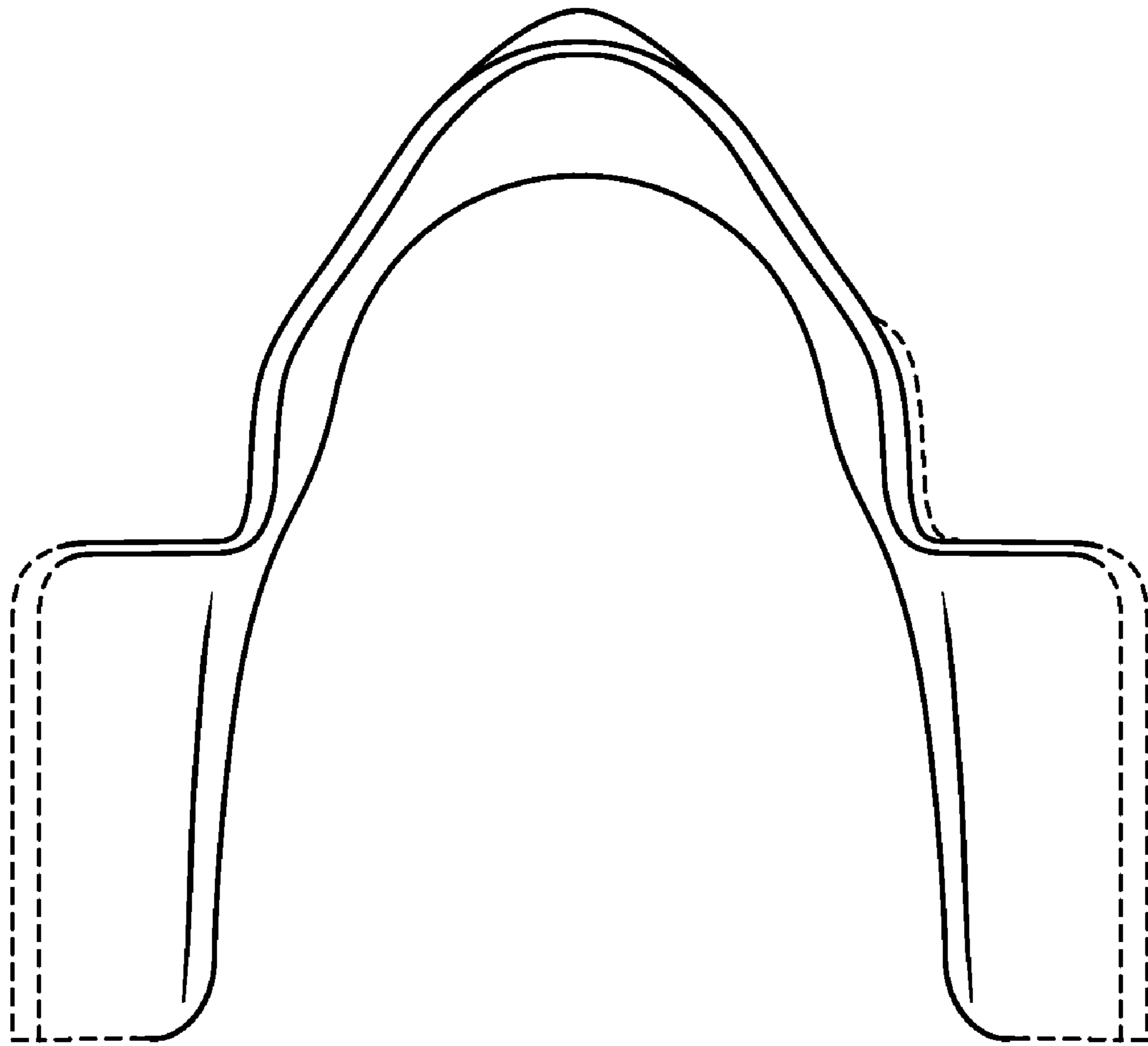

FIG. 15

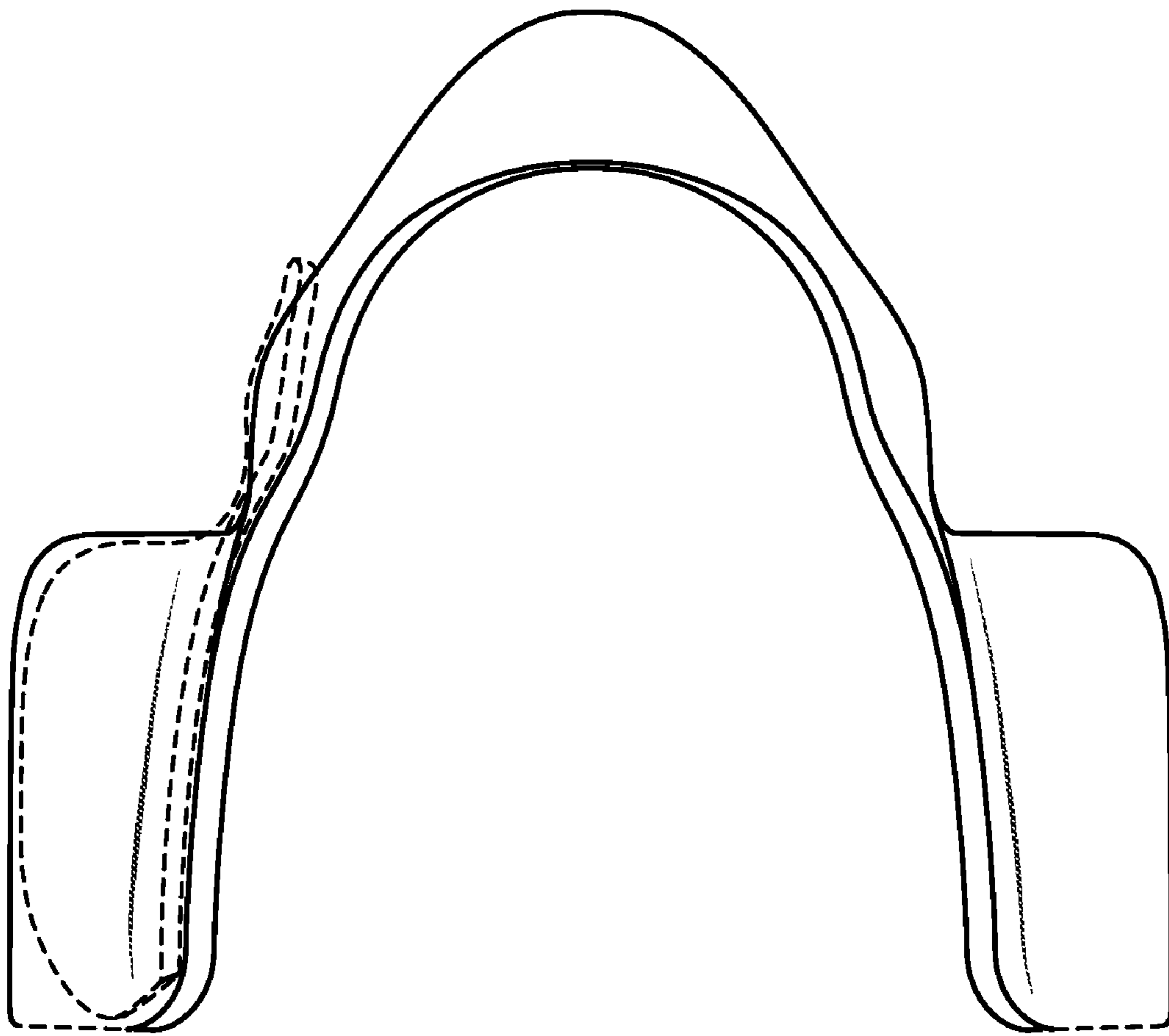

FIG. 16