



US00D548845S

(12) **United States Design Patent**  
**Pfeiffer**

(10) **Patent No.:** **US D548,845 S**

(45) **Date of Patent:** **\*\* Aug. 14, 2007**

(54) **PADDED KNEE BRACE**

(76) Inventor: **Robert Pfeiffer**, 256 Norfolk Rd.,  
Warminster, PA (US) 18974

(\*\*) Term: **14 Years**

(21) Appl. No.: **29/258,347**

(22) Filed: **Apr. 21, 2006**

(51) **LOC (8) Cl.** ..... **24-01**

(52) **U.S. Cl.** ..... **D24/190**

(58) **Field of Classification Search** ..... D24/190-3;  
602/4-6, 20, 27, 61-2, 79; 128/865-6, 878,  
128/876; 604/20-21; 24/442; D29/113;  
473/62; D6/601

See application file for complete search history.

(56) **References Cited**

**U.S. PATENT DOCUMENTS**

3,941,159	A *	3/1976	Toll	138/147
4,706,302	A	11/1987	Padfield et al.	
4,762,320	A *	8/1988	Larsen	473/62
D332,663	S	1/1993	Liszewski	
D346,925	S *	5/1994	Egan	D6/601
5,620,001	A *	4/1997	Byrd et al.	606/202
D382,344	S *	8/1997	Swedberg et al.	D24/190
5,823,984	A *	10/1998	Silverberg	602/61
D404,817	S *	1/1999	Gomez	D24/190
D425,996	S *	5/2000	Owen, Jr.	D24/206

6,083,254	A *	7/2000	Evans	607/96
6,145,508	A	11/2000	Spid, Jr.	
D444,879	S *	7/2001	Rodgers	D24/192
D502,545	S *	3/2005	Murphy	D24/192
6,936,018	B2 *	8/2005	Chalek	602/2
D517,215	S *	3/2006	Cheney	D24/190

\* cited by examiner

*Primary Examiner*—Louis S. Zarfes

*Assistant Examiner*—Susan E Krakower

(57) **CLAIM**

The ornamental design for a padded knee brace, as shown and described.

**DESCRIPTION**

FIG. 1 is a perspective view showing a padded knee brace showing the new invention;

FIG. 2 is a perspective view showing the present invention in use;

FIG. 3 is a left side elevational view thereof;

FIG. 4 is a top plan view thereof; and,

FIG. 5 is a right side elevational view thereof.

The broken line showing of a woman in FIG. 2 is included for the purpose of illustrating environmental structure and forms no part of the claimed design.

**1 Claim, 3 Drawing Sheets**

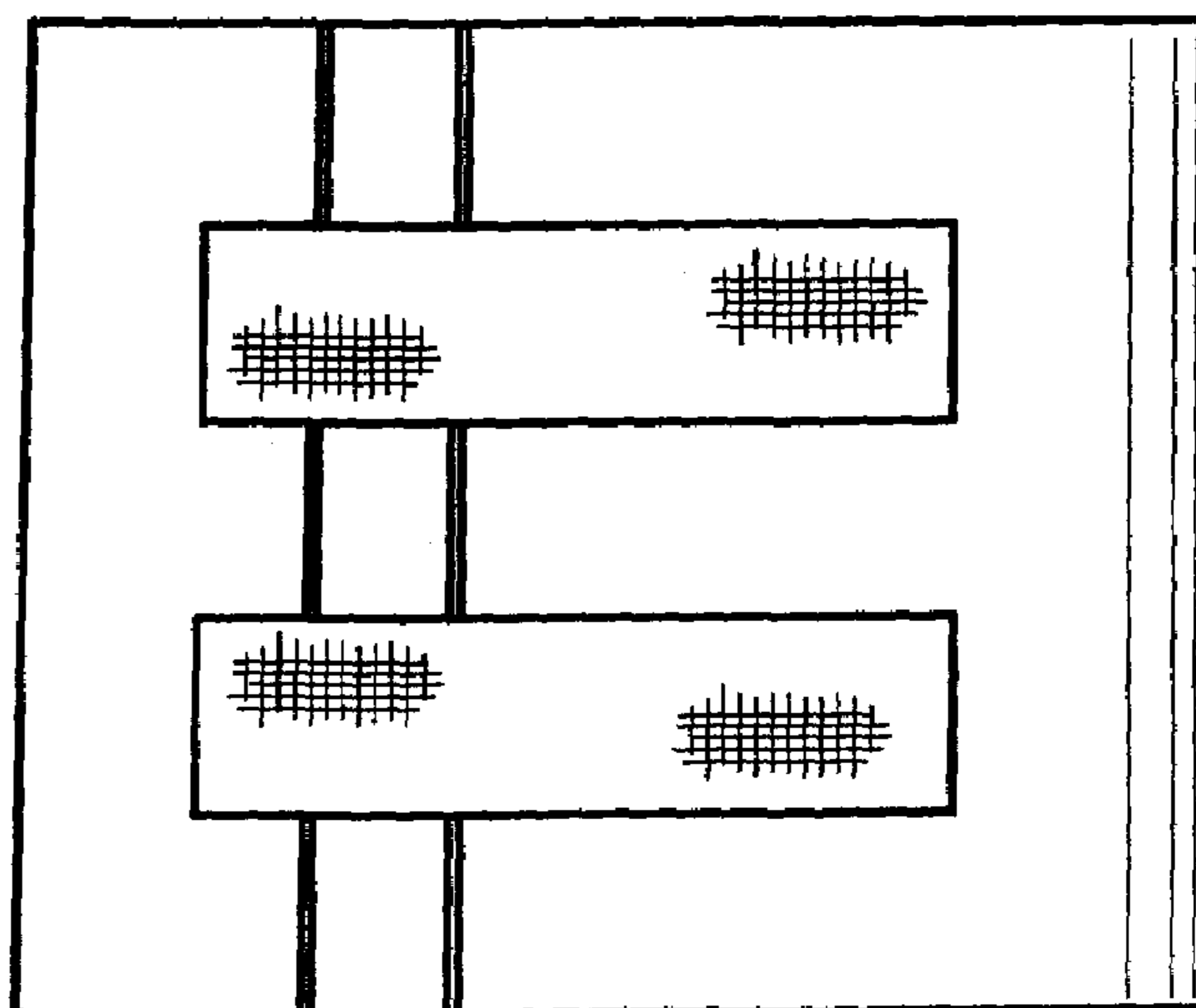
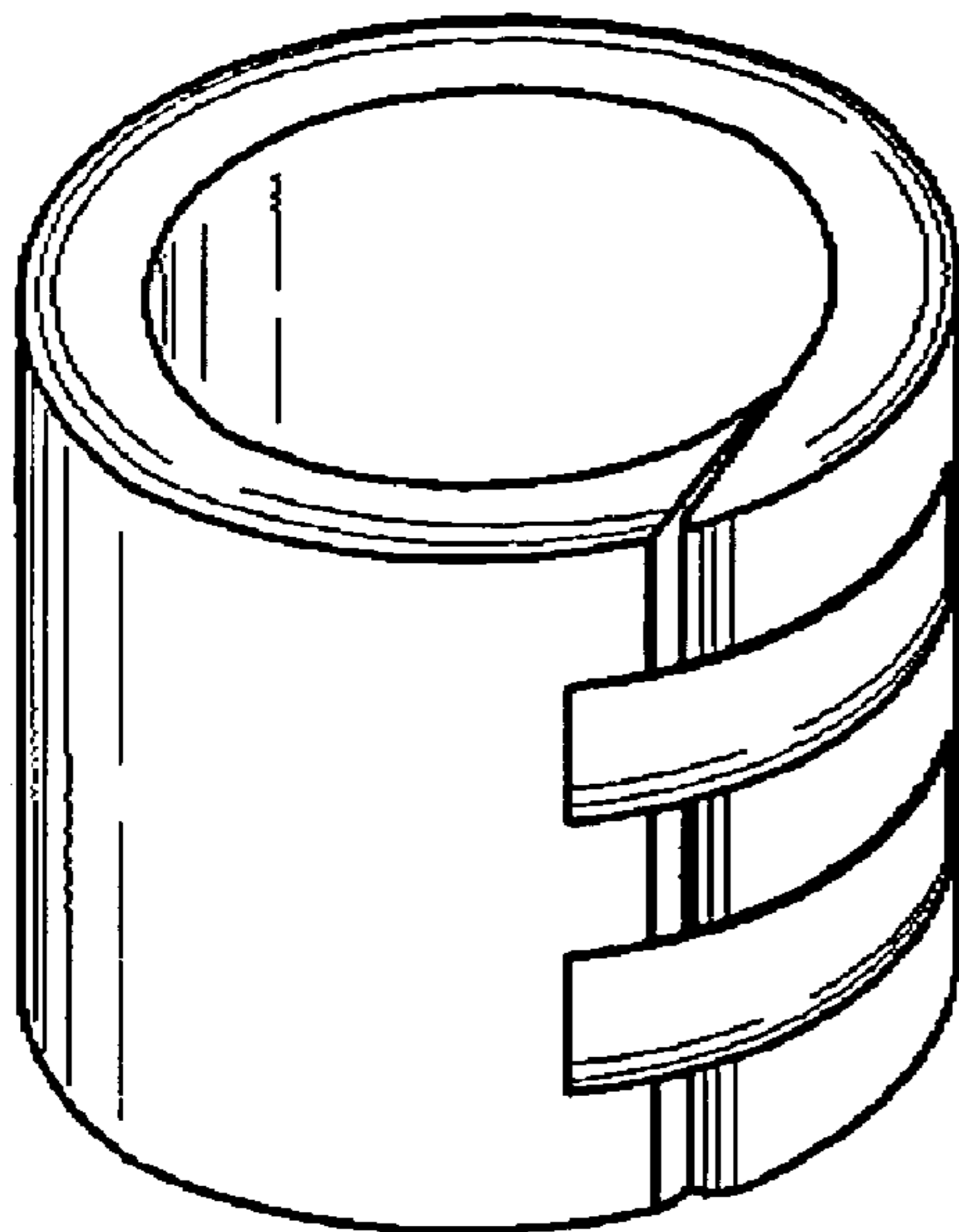

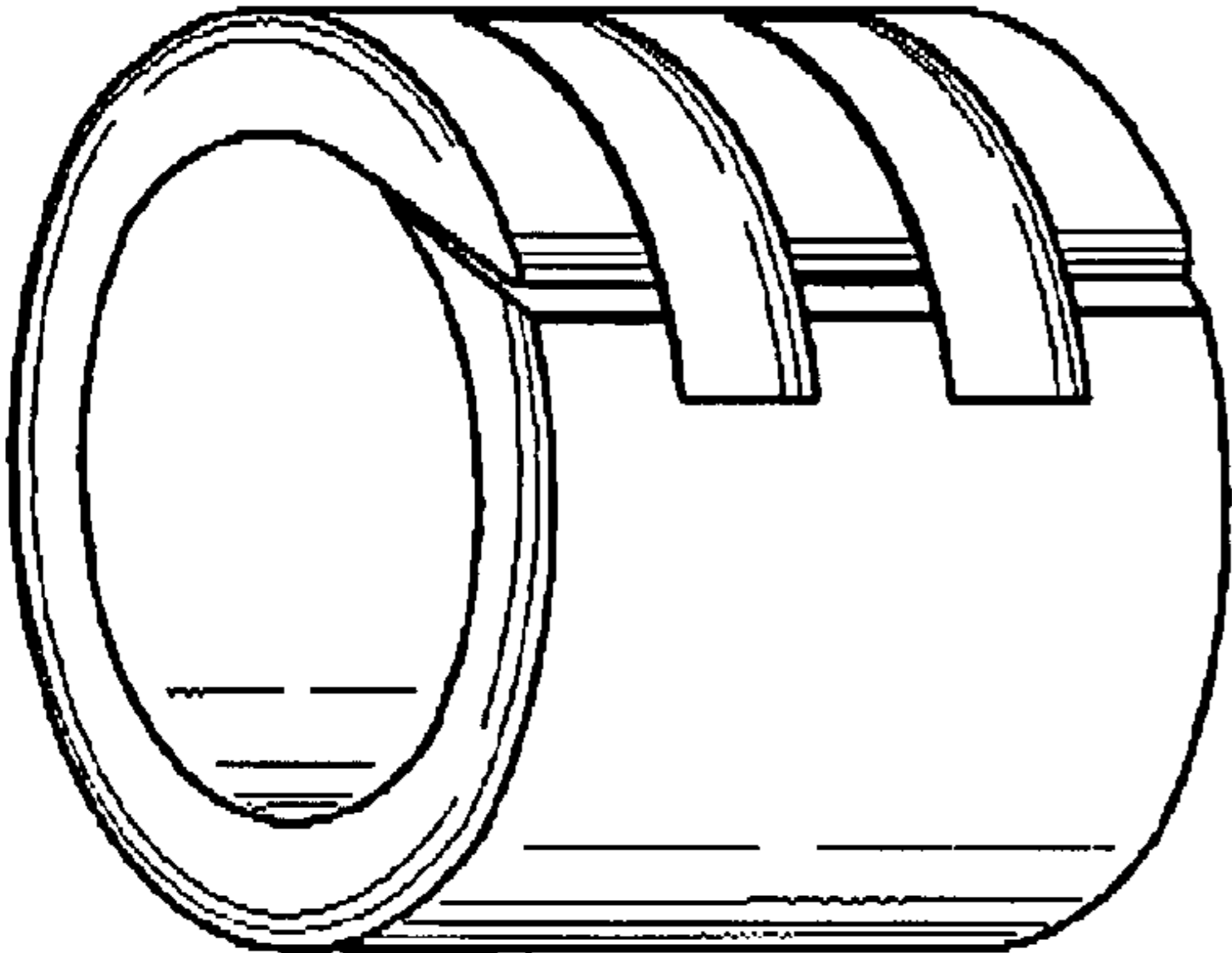

FIG. 1

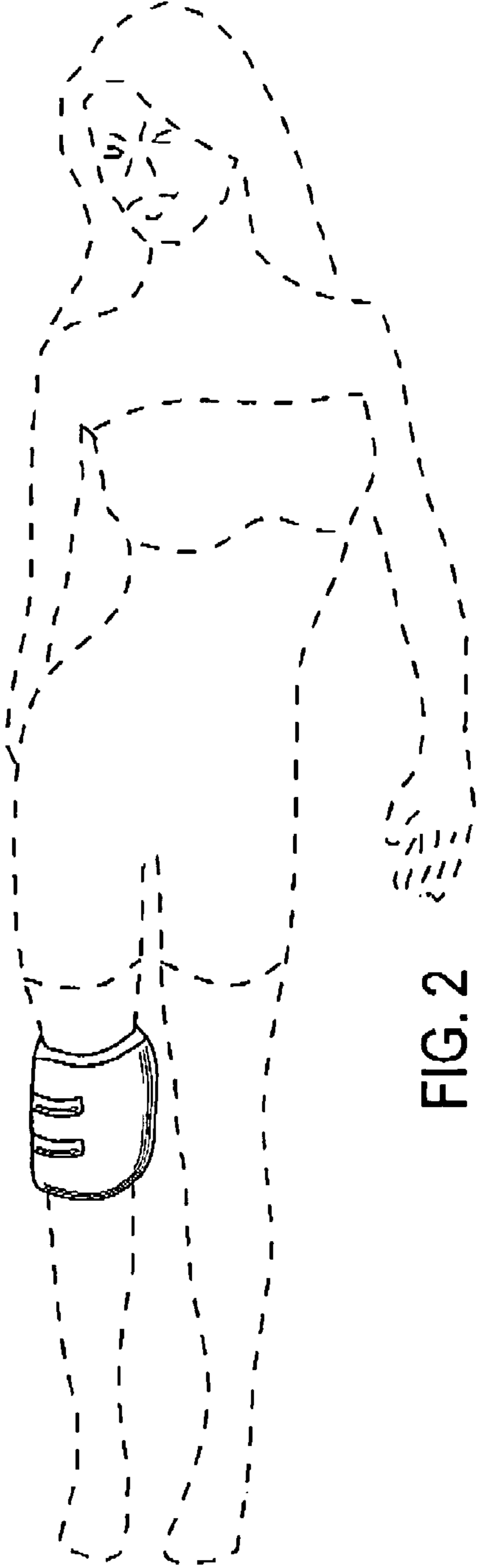

FIG. 2

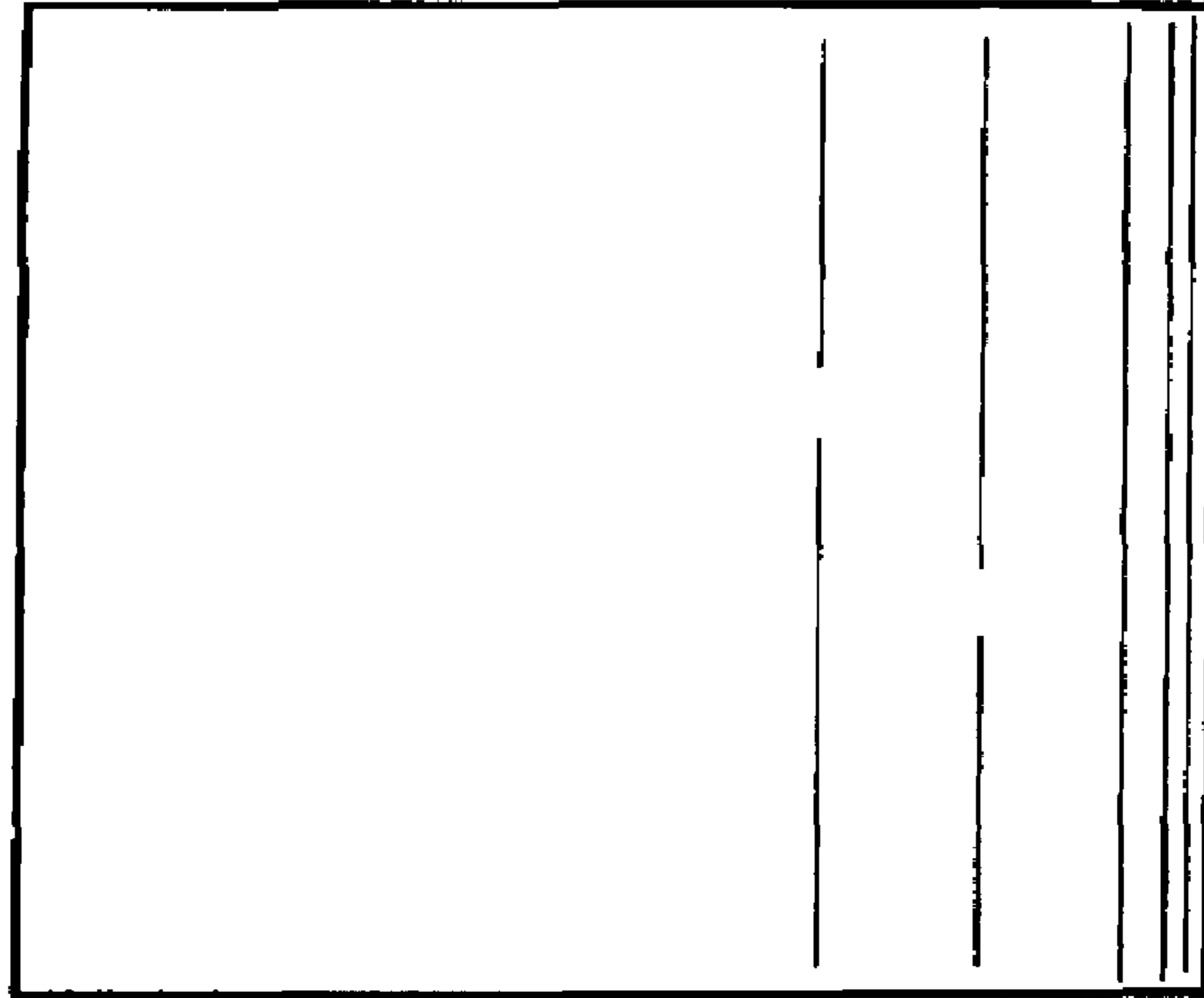

FIG. 3

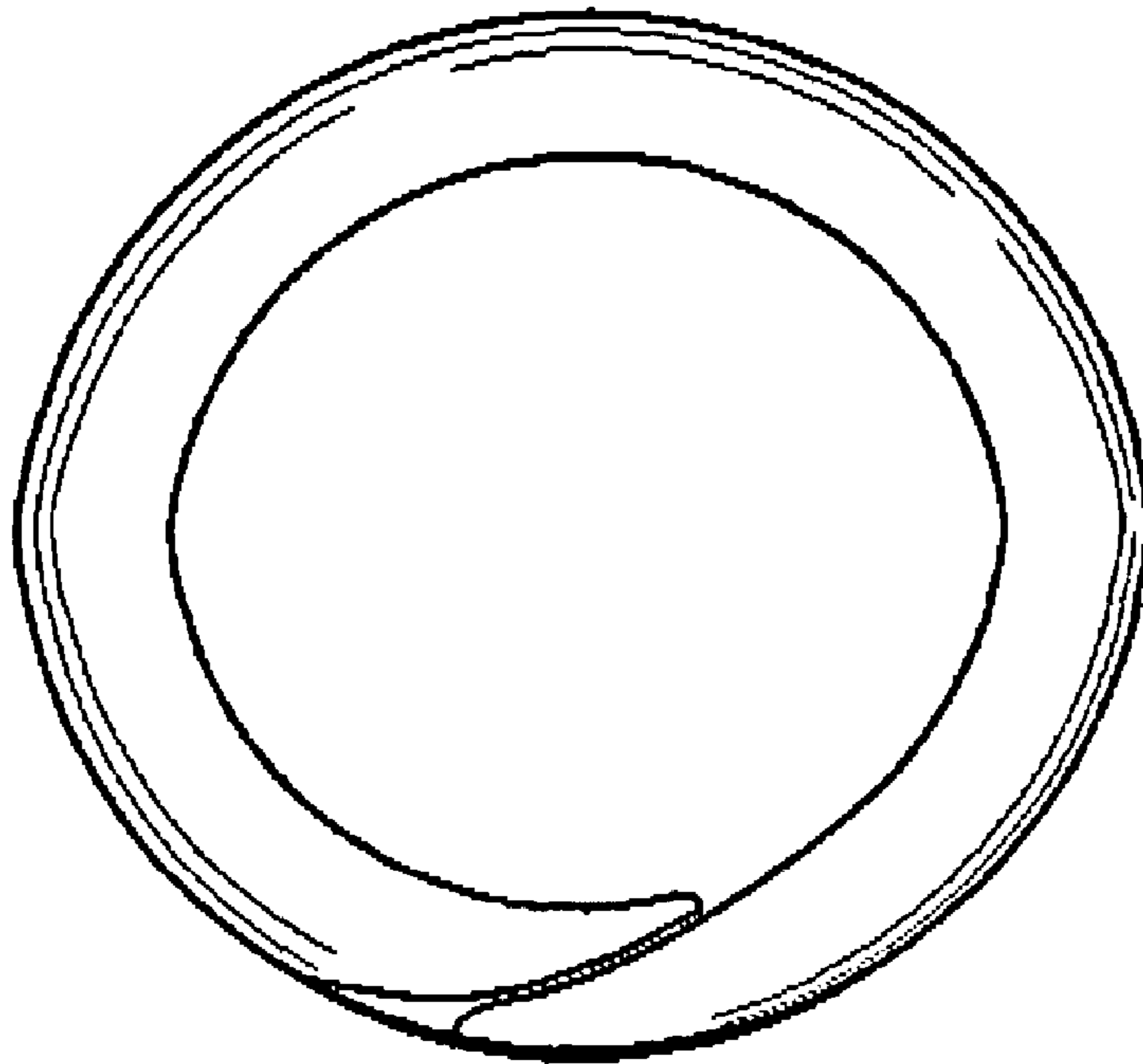

FIG. 4

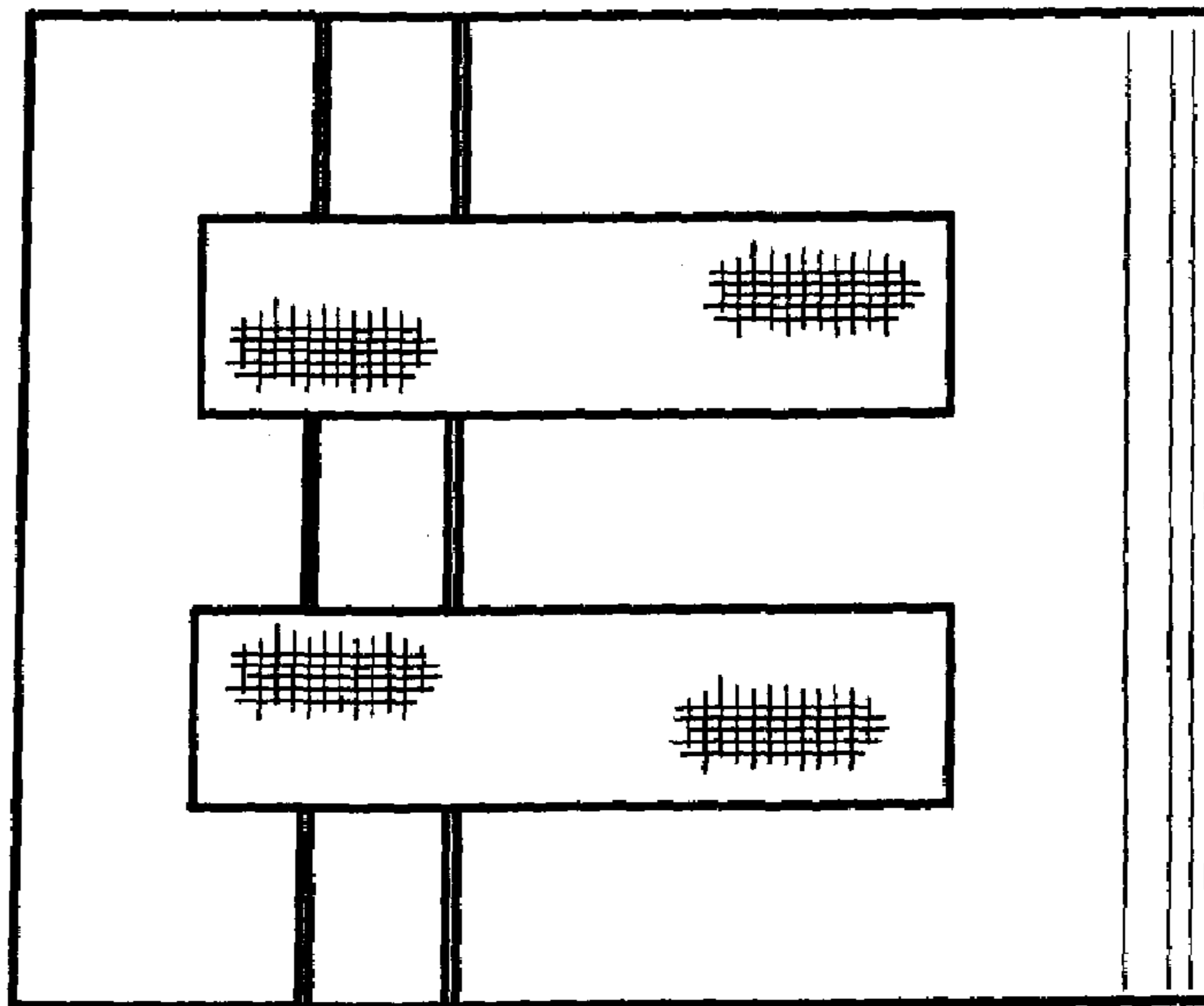

FIG. 5