

US00D548839S

(12) **United States Design Patent**
Kobayakawa et al.

(10) **Patent No.:** **US D548,839 S**

(45) **Date of Patent:** **** Aug. 14, 2007**

(54) **SPHYGMOMANOMETER**

(75) Inventors: **Tatsutoshi Kobayakawa**, Tokyo (JP);
Hiroshi Kajimoto, Tokyo (JP)

(73) Assignee: **Tanita Corporation**, Tokyo (JP)

(**) Term: **14 Years**

(21) Appl. No.: **29/255,190**

(22) Filed: **Mar. 7, 2006**

(30) **Foreign Application Priority Data**

Sep. 29, 2005 (JP) 2005-028174

(51) **LOC (8) Cl.** **24-02**

(52) **U.S. Cl.** **D24/165**

(58) **Field of Classification Search** D24/165-169,
D24/186; 600/479, 480, 481, 482, 485, 490,
600/493, 495, 500

See application file for complete search history.

(56) **References Cited**

U.S. PATENT DOCUMENTS

- D403,770 S * 1/1999 Ozaki et al. D24/165
- D473,651 S * 4/2003 Inagaki et al. D24/165
- D475,788 S * 6/2003 Inagaki et al. D24/165
- D496,104 S * 9/2004 Eda et al. D24/165
- D522,657 S * 6/2006 Murphy et al. D24/186

D525,710 S * 7/2006 Kobayashi et al. D24/165

* cited by examiner

Primary Examiner—Louis S. Zarfes

Assistant Examiner—Anhdao Doan

(74) *Attorney, Agent, or Firm*—McDermott Will & Emery
LLP

(57) **CLAIM**

The ornamental design for a sphygmomanometer, as shown and described.

DESCRIPTION

FIG. 1 is a front perspective view of the sphygmomanometer showing the new design;

FIG. 2 is a front view of the sphygmomanometer;

FIG. 3 is a rear view of the sphygmomanometer;

FIG. 4 is a side view of the sphygmomanometer;

FIG. 5 is another side view of the sphygmomanometer;

FIG. 6 is a top view of the sphygmomanometer; and,

FIG. 7 is a bottom view of the sphygmomanometer.

The broken lines showing various elements of the sphygmomanometer are included for the purpose of illustrating non-claimed subject matter and forms no part of the claimed design.

1 Claim, 5 Drawing Sheets

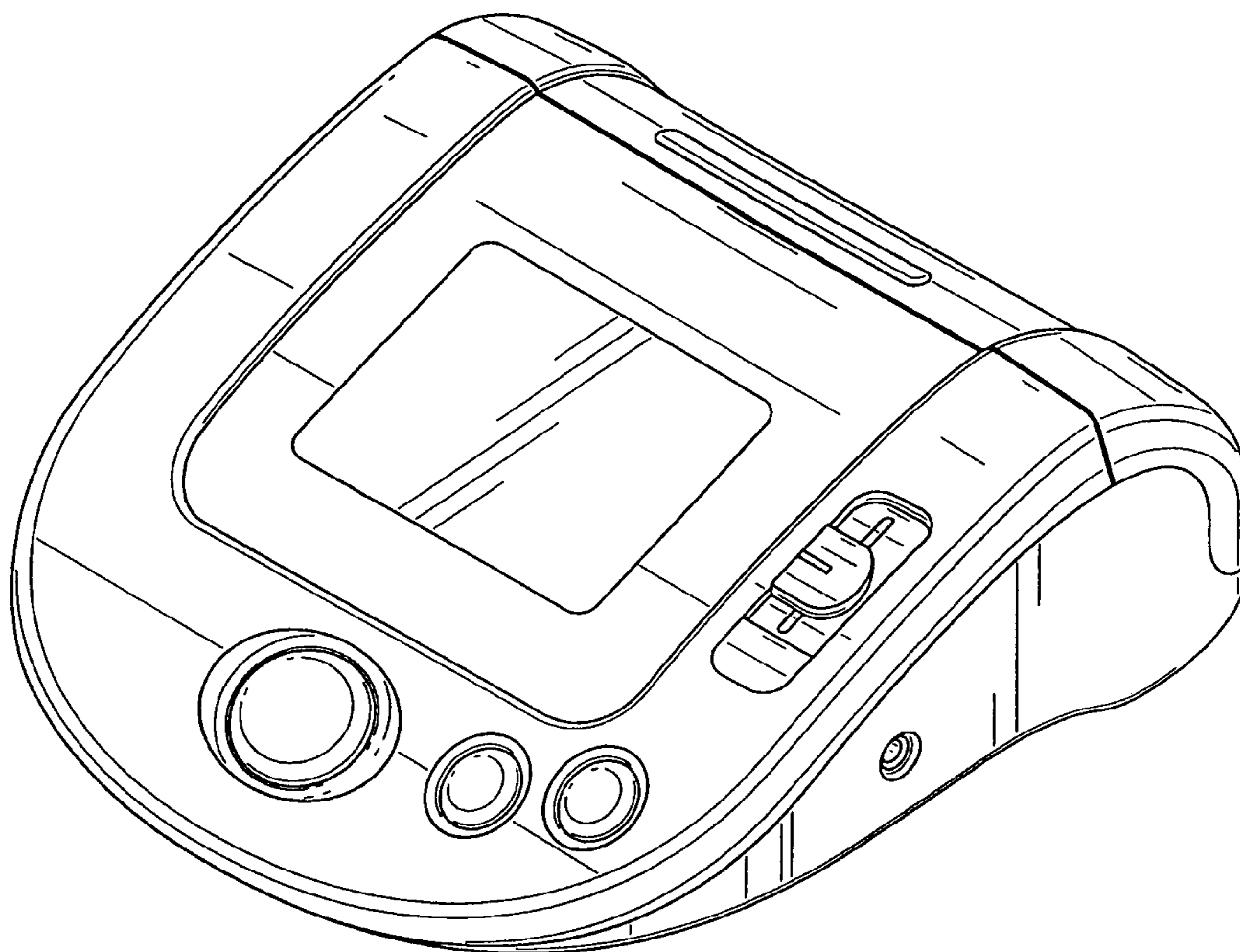

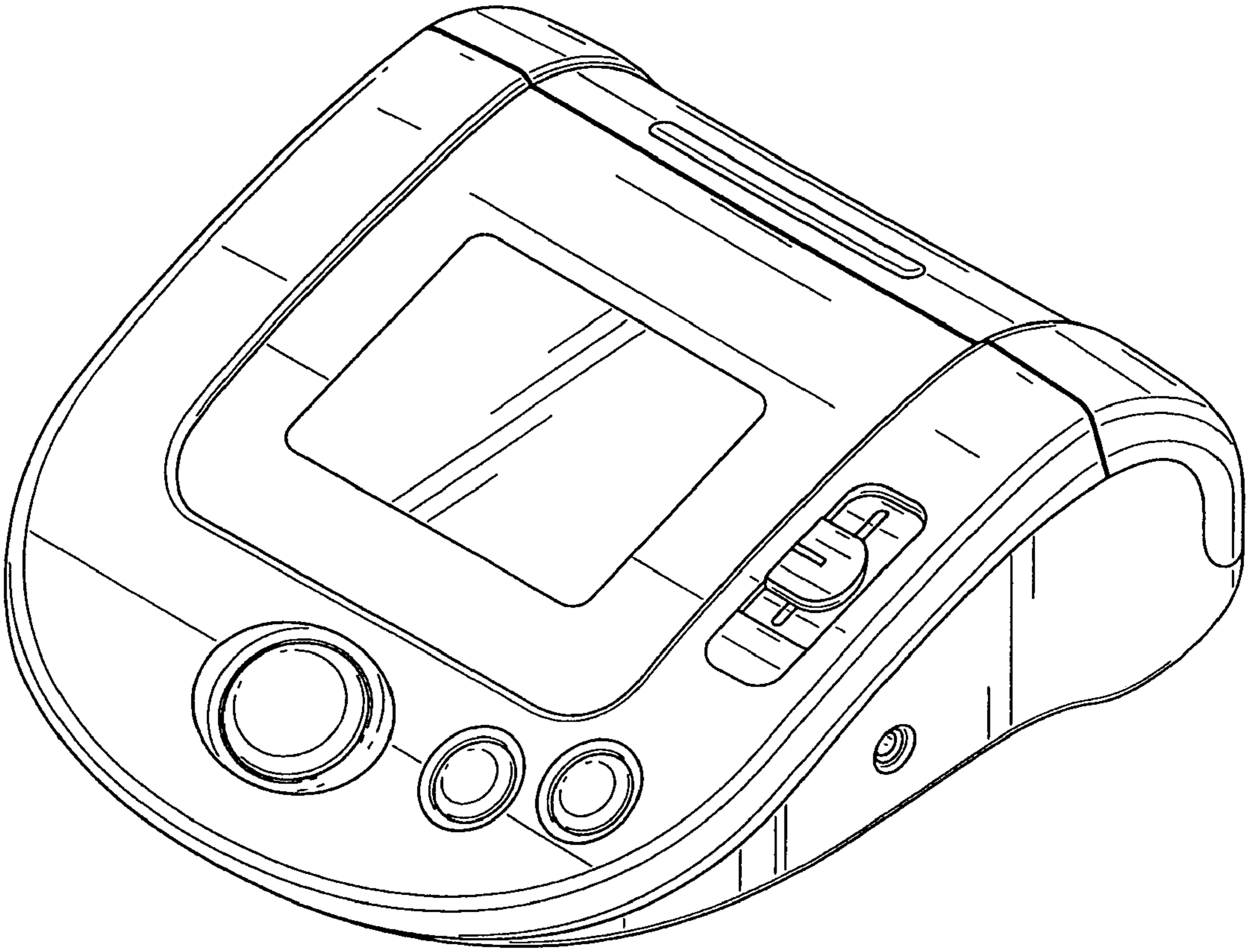

FIG. 1

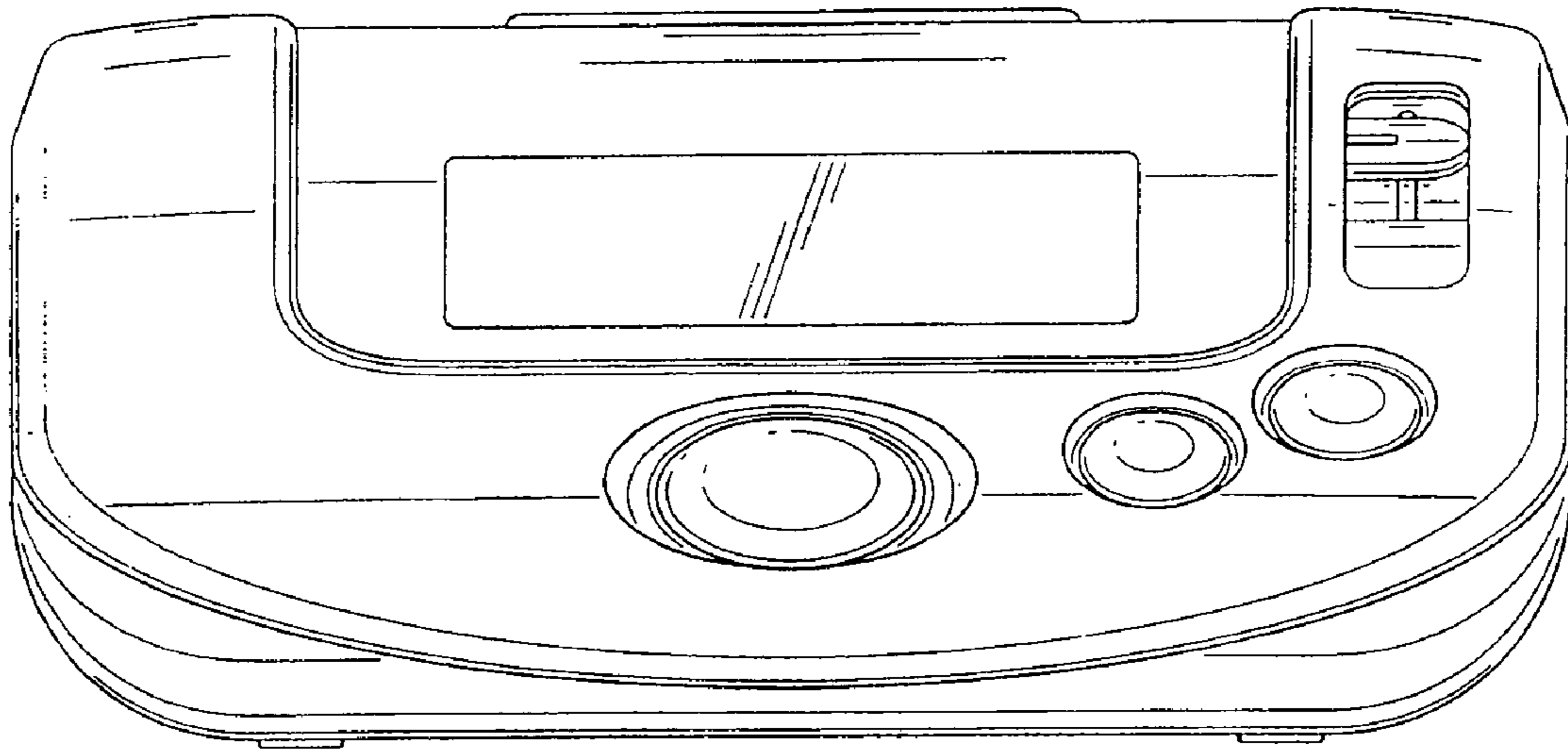

FIG. 2

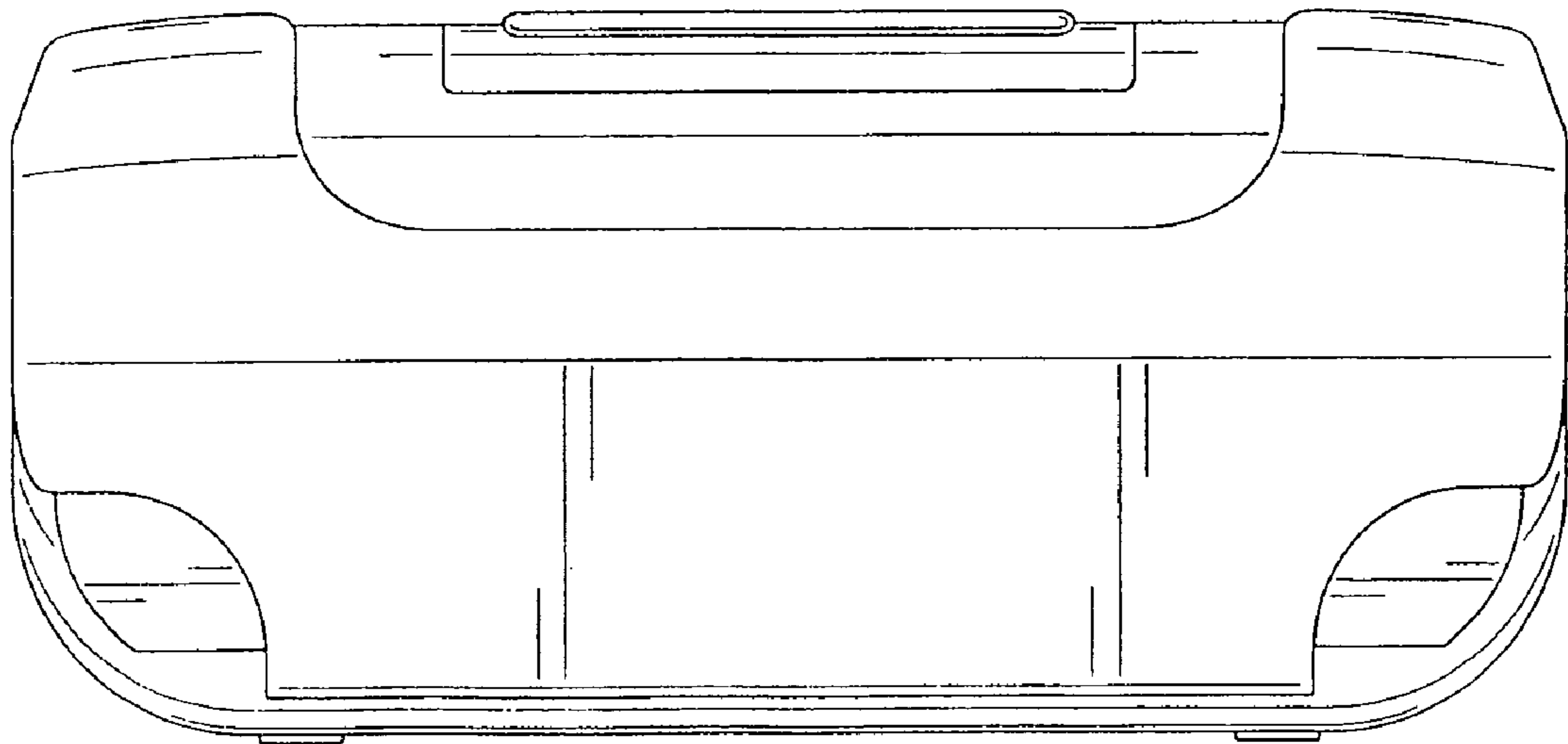

FIG. 3

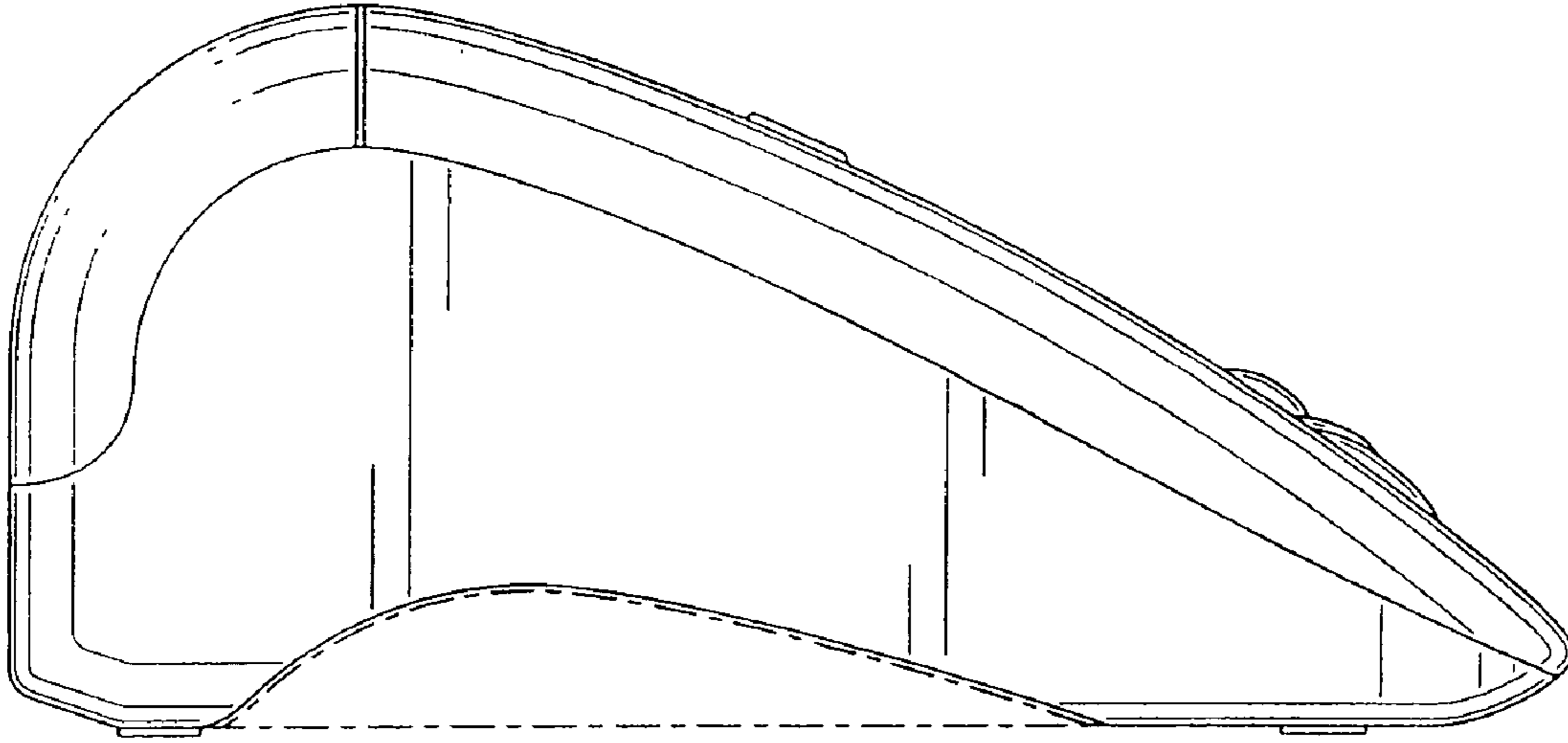

FIG. 4

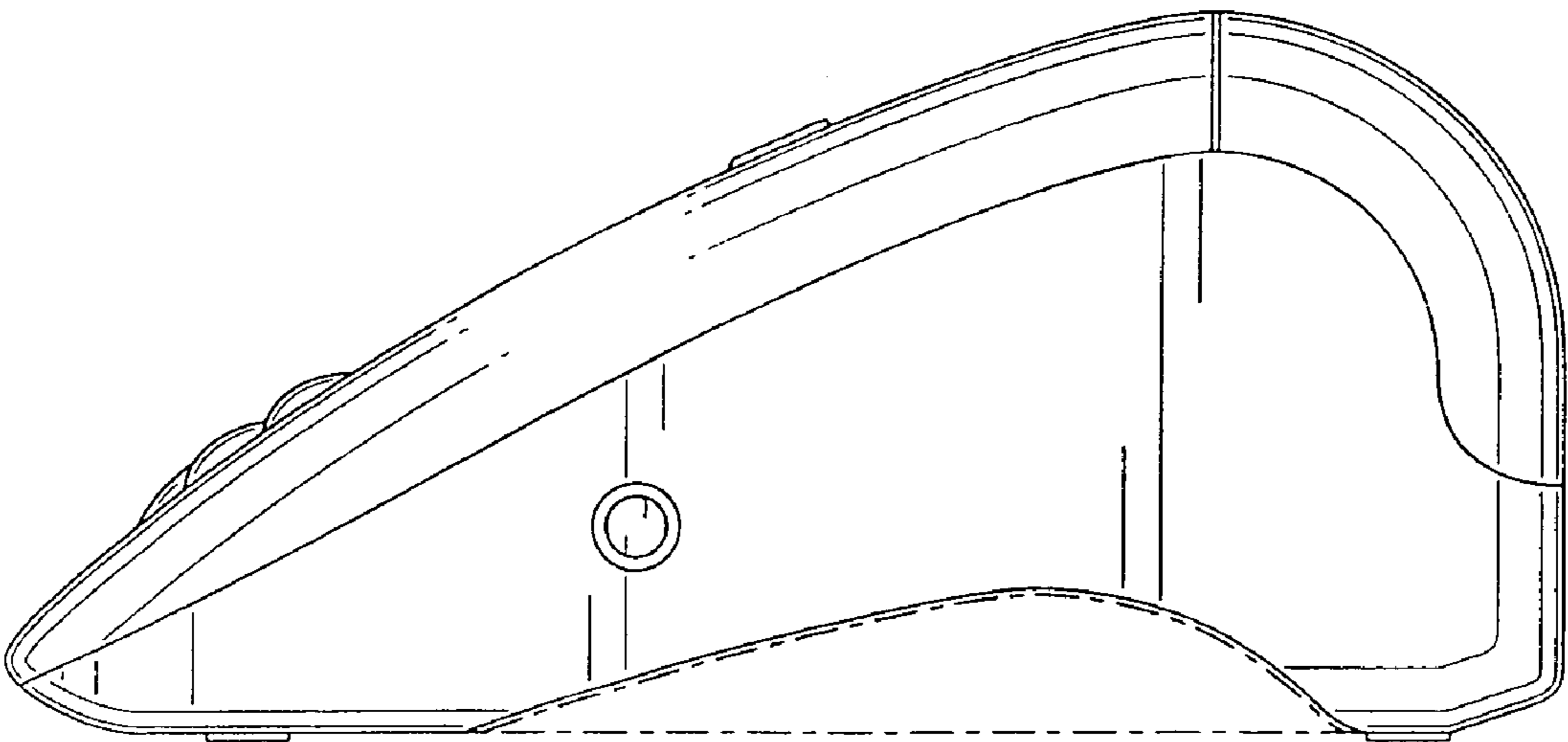

FIG. 5

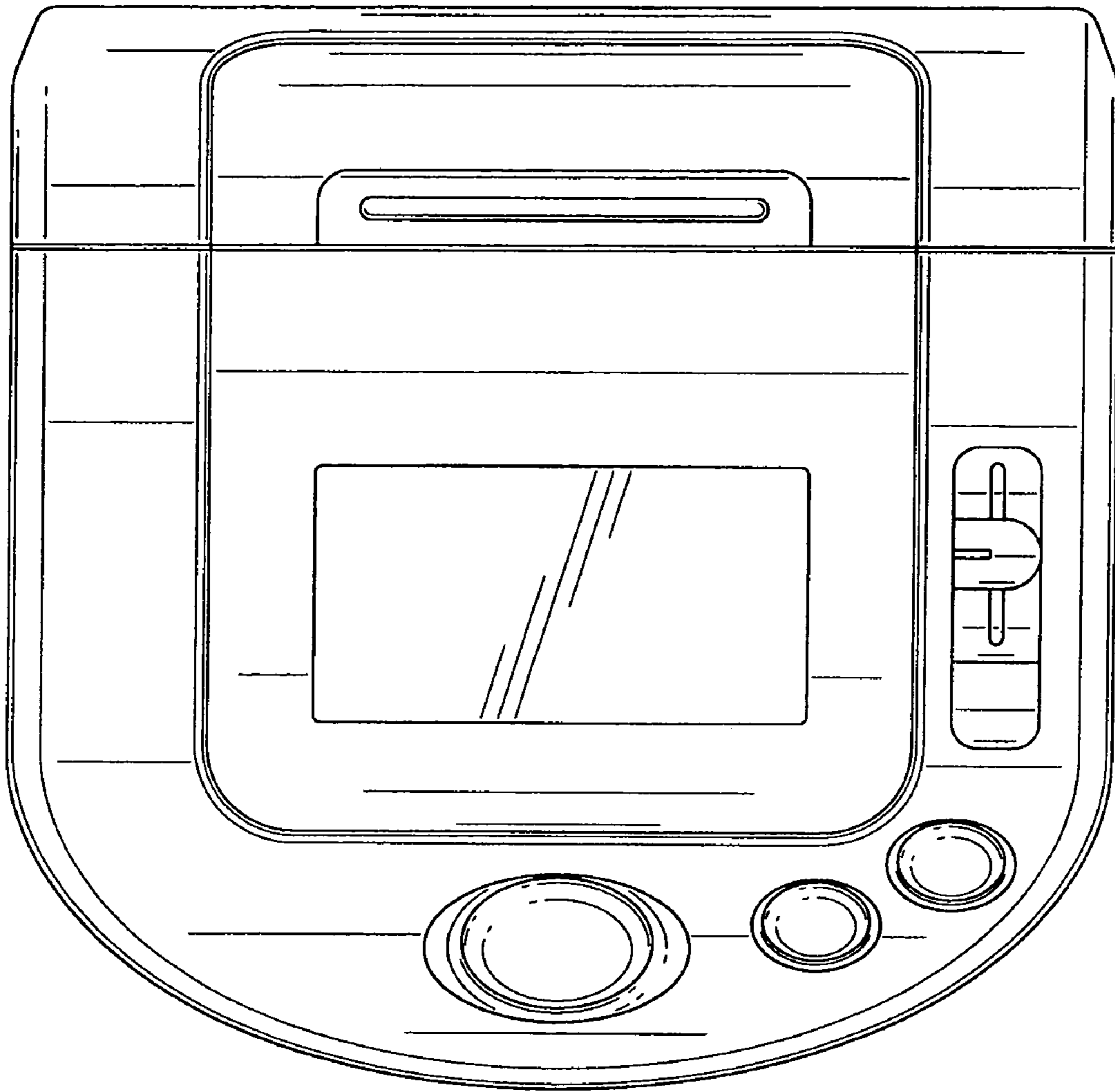

FIG. 6

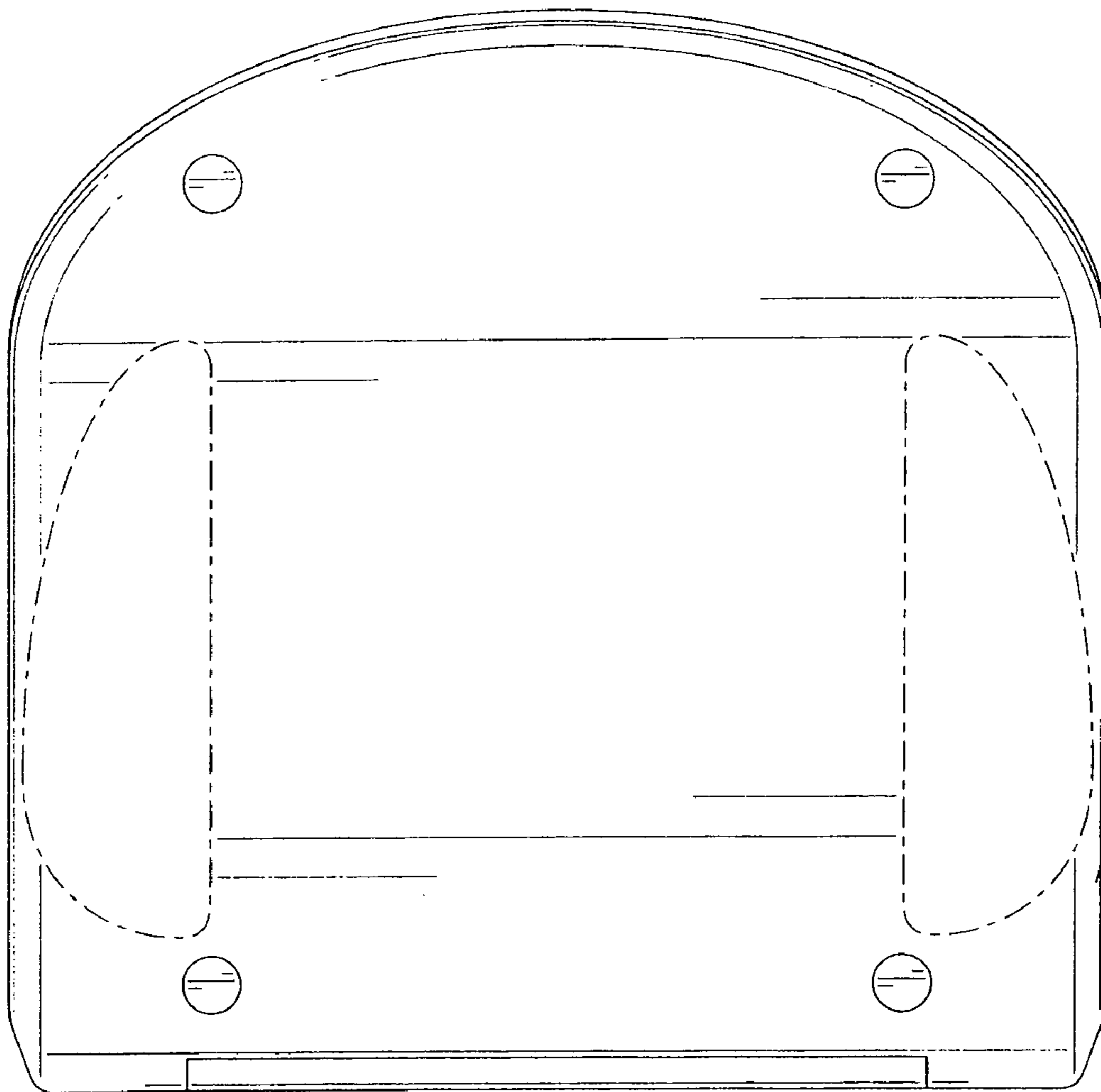

FIG. 7