



US00D548797S

(12) **United States Design Patent**  
**O'Neill**

(10) **Patent No.:** **US D548,797 S**

(45) **Date of Patent:** **\*\* Aug. 14, 2007**

(54) **BOARD GAME**

(76) Inventor: **John Edward O'Neill**, 3375 Alma St.,  
#374, Palo Alto, CA (US) 94306

(\*\*) Term: **14 Years**

(21) Appl. No.: **29/241,268**

(22) Filed: **Oct. 24, 2005**

(51) **LOC (8) Cl.** ..... **21-01**

(52) **U.S. Cl.** ..... **D21/349; D21/385**

(58) **Field of Classification Search** ..... D21/334-368,  
D21/389; 273/236-288

See application file for complete search history.

(56) **References Cited**

U.S. PATENT DOCUMENTS

D228,775 S *	10/1973	Randell	.....	D21/349
3,951,411 A	4/1976	Hill et al.	.....	273/134 AA
3,973,775 A	8/1976	Bolan et al.		
4,093,237 A	6/1978	Weiss	.....	273/260
D248,785 S *	8/1978	Haber	.....	D21/389
4,261,572 A *	4/1981	Breinholt	.....	273/145 C
4,306,724 A	12/1981	Brzezinski et al.	.....	273/243
D291,899 S *	9/1987	Hanson et al.	.....	D21/336
4,815,998 A *	3/1989	McGuire	.....	446/8
D305,343 S *	1/1990	Epperson et al.	.....	D21/336
D349,307 S *	8/1994	Rockwell	.....	D21/389
5,518,247 A *	5/1996	Robichaud	.....	273/236
6,581,933 B1 *	6/2003	Zivan	.....	273/241
D479,283 S	9/2003	Heil	.....	D21/372
D483,414 S	12/2003	Wilson, Sr.	.....	D21/322
6,669,196 B1	12/2003	Washko	.....	273/243
6,669,197 B1	12/2003	Lund et al.	.....	273/243
6,688,596 B2	2/2004	Nielsen	.....	273/120 R
6,692,002 B2	2/2004	Kummer	.....	273/272

\* cited by examiner

Primary Examiner—Sandra Morris

(74) Attorney, Agent, or Firm—Haverstock & Owens LLP

(57) **CLAIM**

I claim the ornamental design for board game, as shown and described.

**DESCRIPTION**

FIG. 1 is a top plan view of the packaging for the board game, shown broken away for ease of illustration;

FIG. 2 is a front elevational view of the assembled game and packaging thereof;

FIG. 3 is a perspective view thereof;

FIG. 4 is a folding container for the board game, shown broken away for ease of illustration;

FIG. 5 is a perspective view of the game pieces for the board game, shown broken away for ease of illustration;

FIG. 6 is a perspective view of the game board and game pieces;

FIG. 7 is a top view of the board for the board game, shown broken away for ease of illustration;

FIG. 8 is a perspective view of the board for the board game, shown broken away for ease of illustration;

FIG. 9 is a side perspective view thereof;

FIG. 10 is a side perspective view thereof;

FIG. 11 is another side perspective view thereof;

FIG. 12 is a side elevational view thereof;

FIG. 13 is a bottom perspective view thereof;

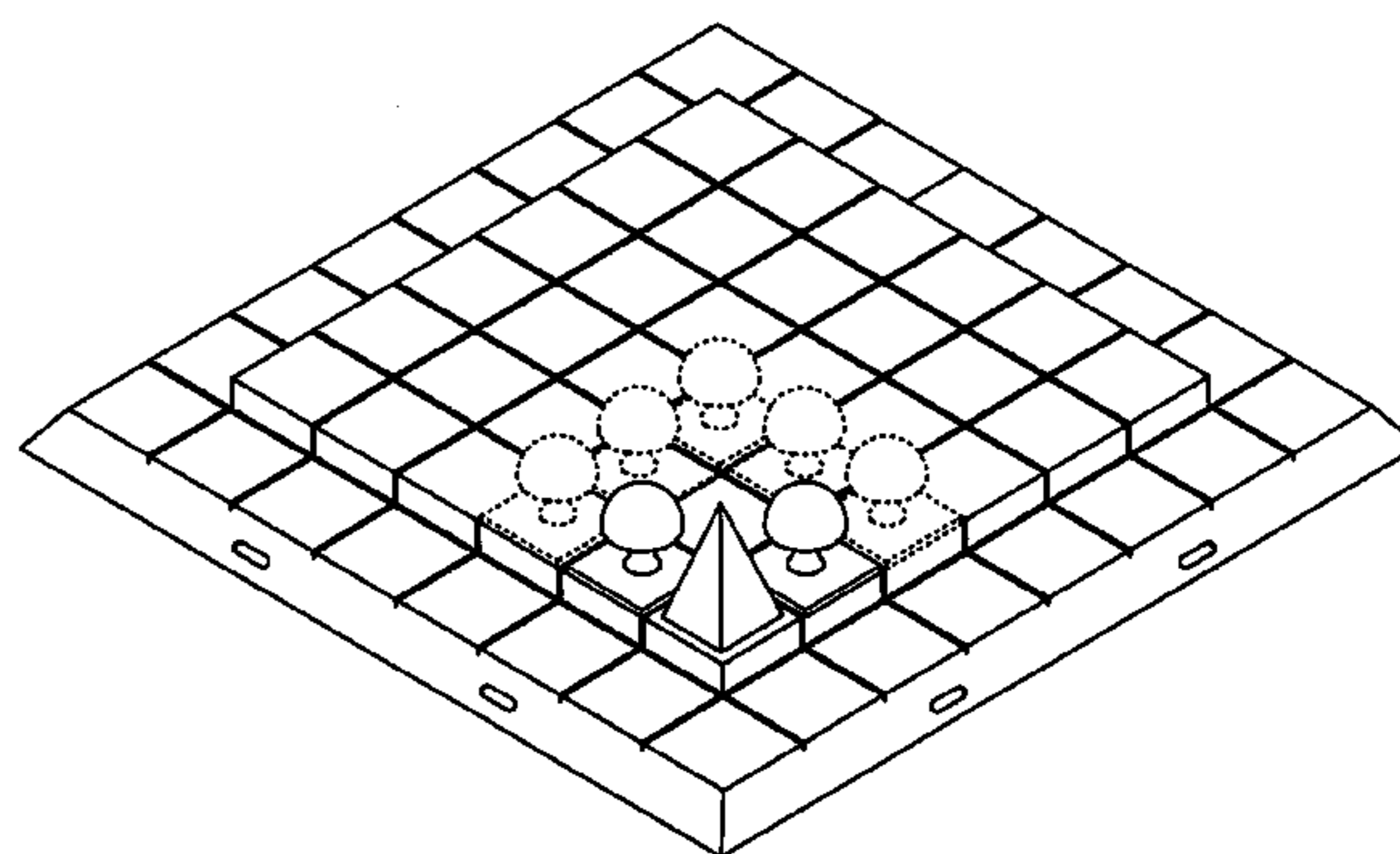
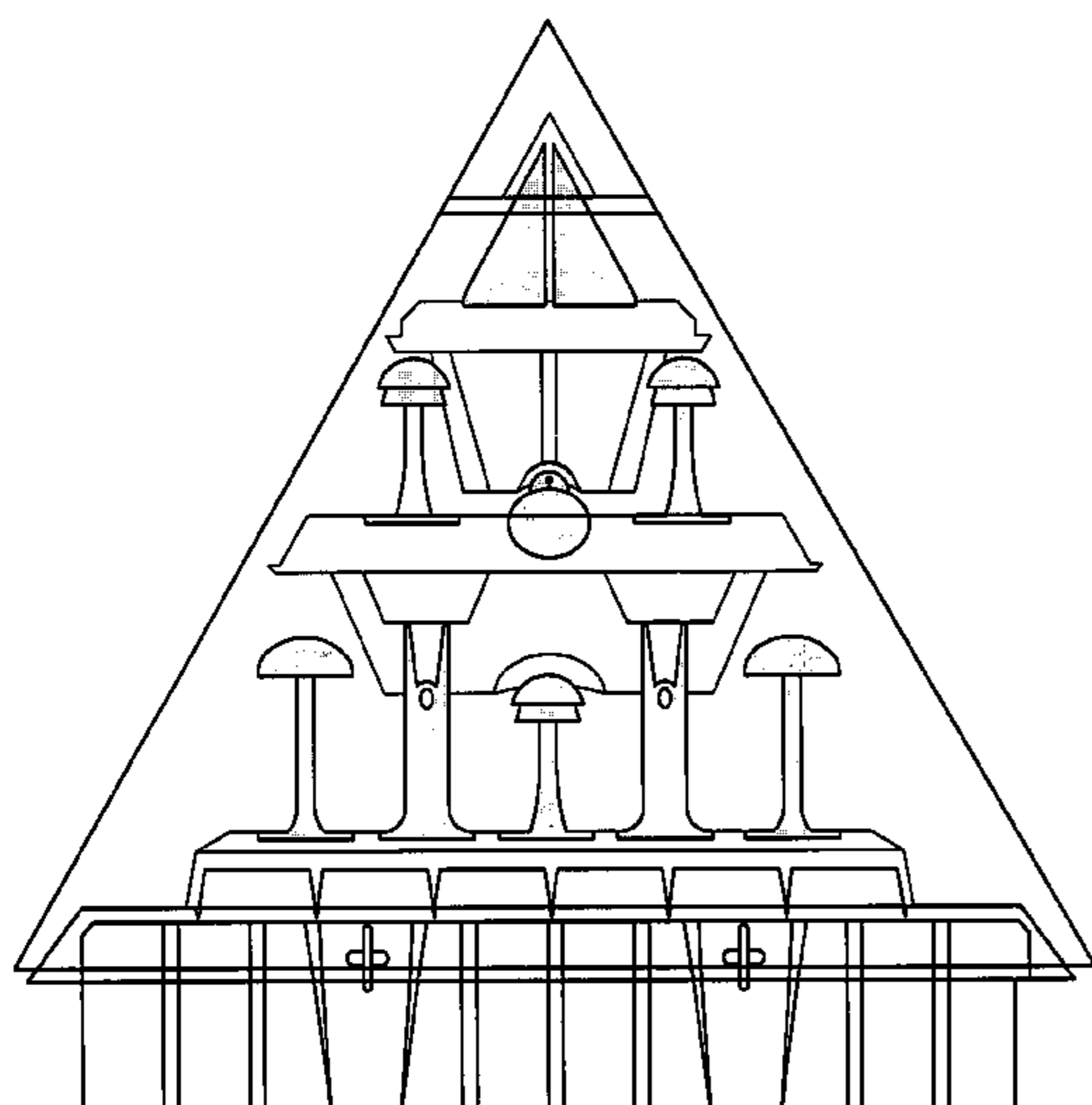
FIG. 14 is an enlarged view of the contours of the board game, shown broken away for ease of illustration;

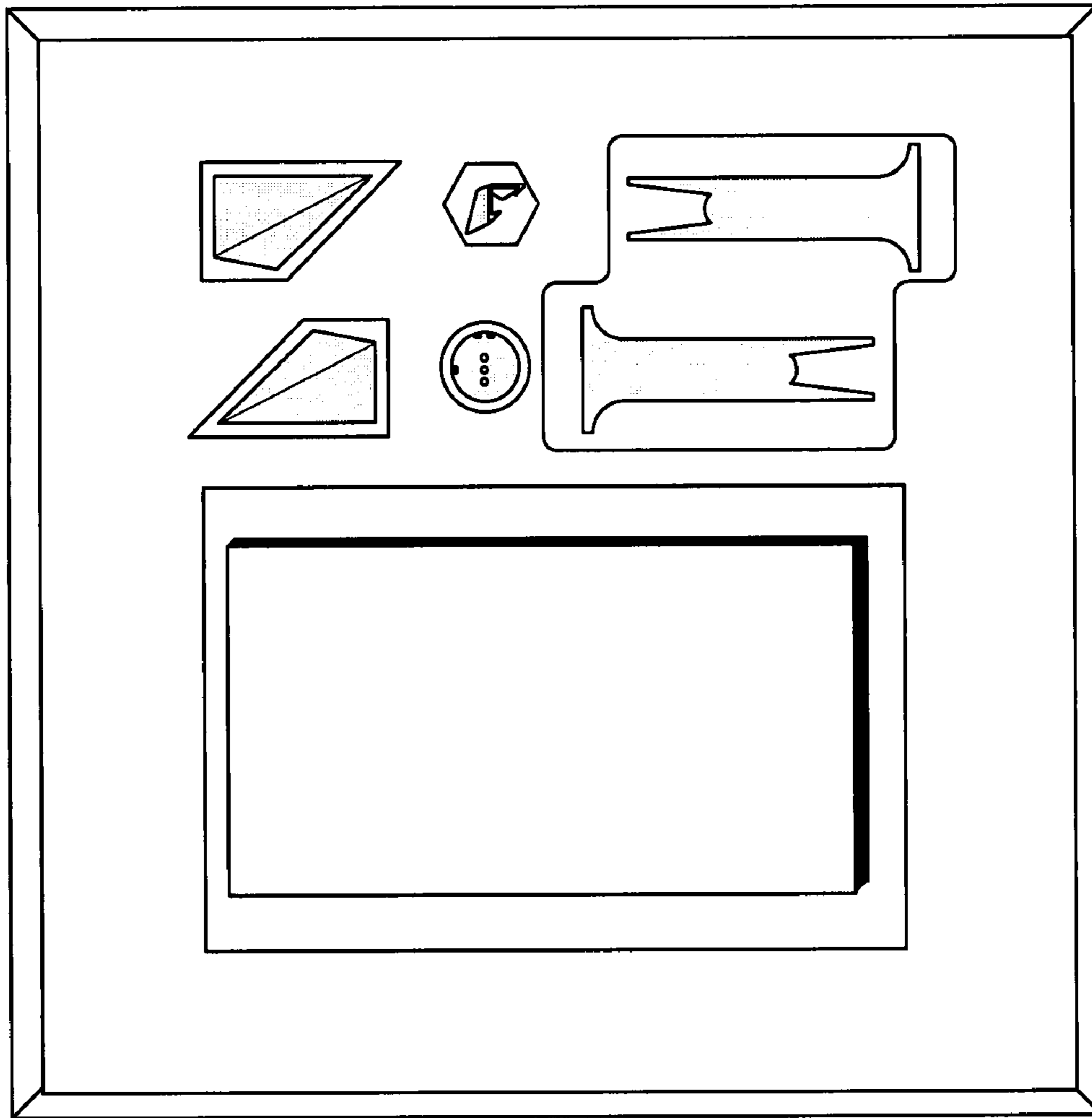
FIG. 15 is another enlarged view of the contours of the board game, shown broken away for ease of illustration; and,

FIG. 16 is another enlarged view of the contours of the board game, shown broken away for ease of illustration.

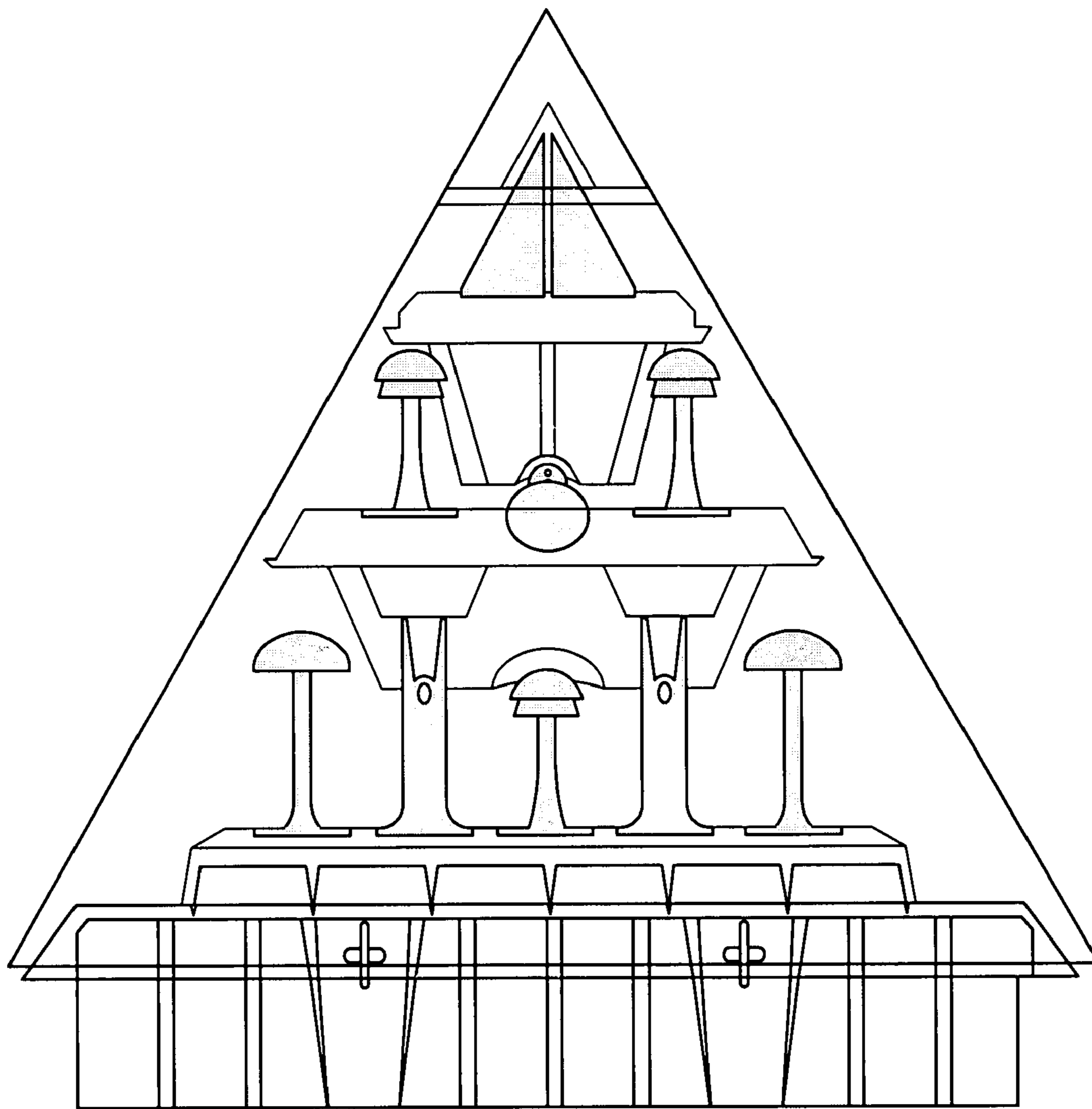
The broken line showing is for illustrative purposes only, and forms no part of the claimed design.

**1 Claim, 15 Drawing Sheets**

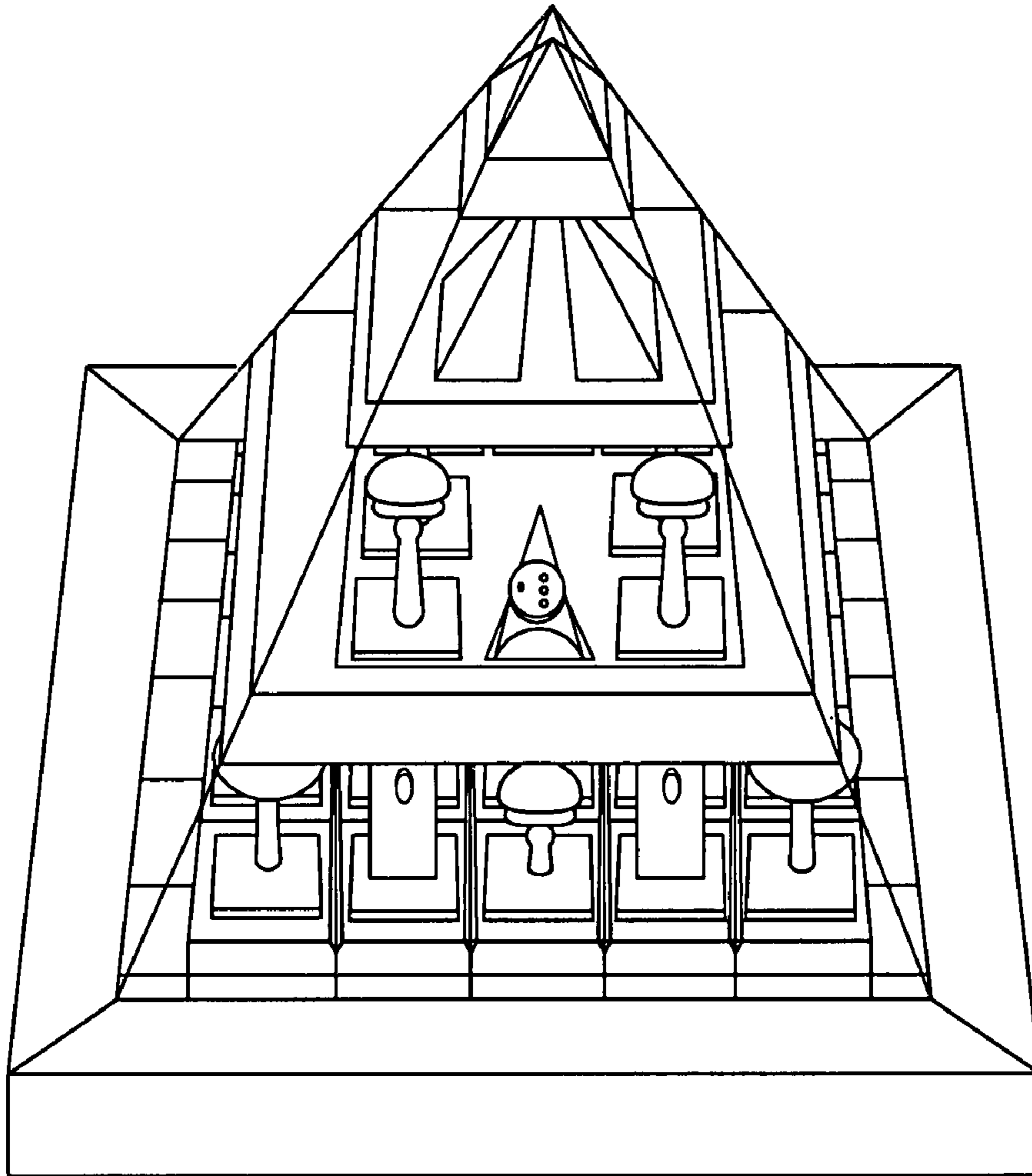




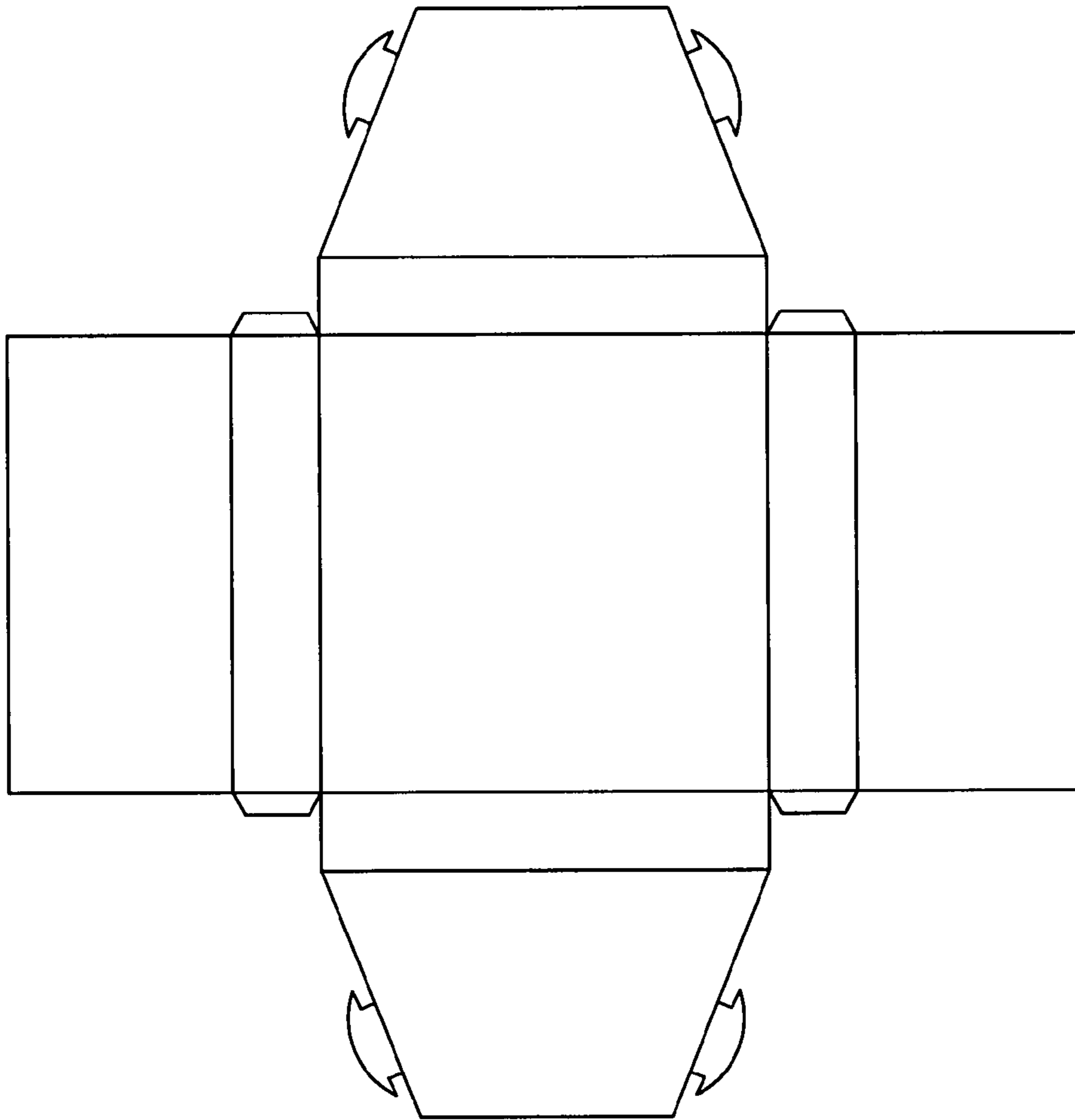
**Fig. 1**



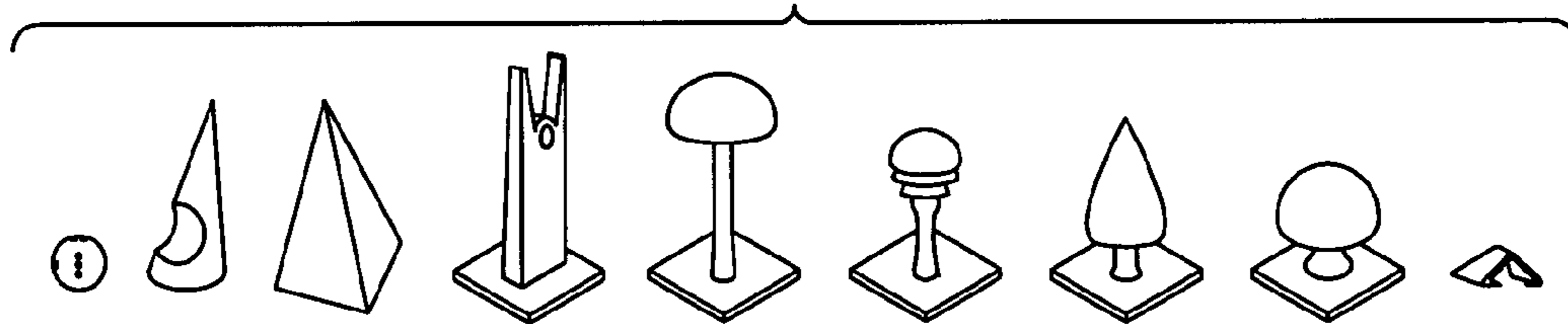
**Fig. 2**



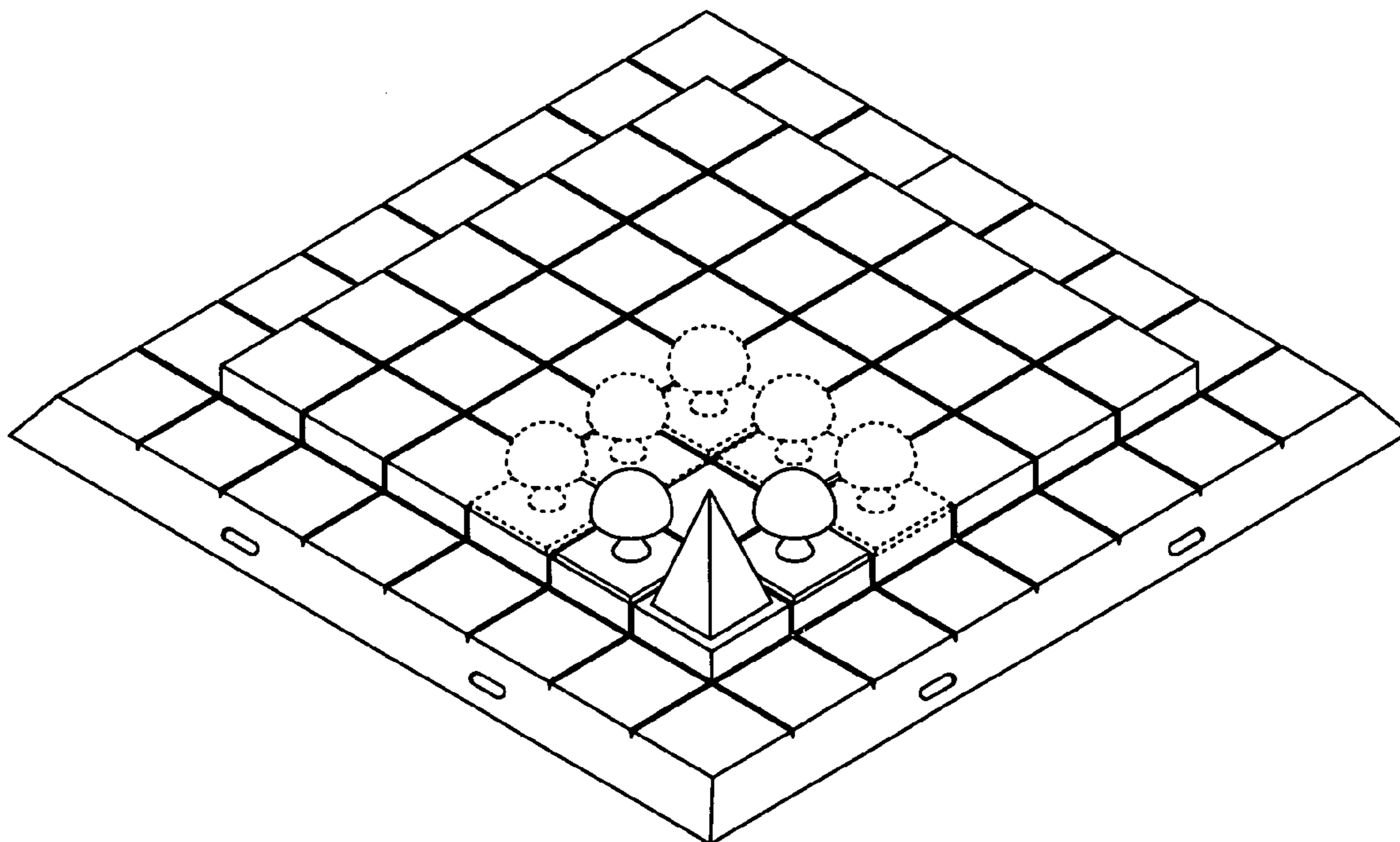
**Fig. 3**



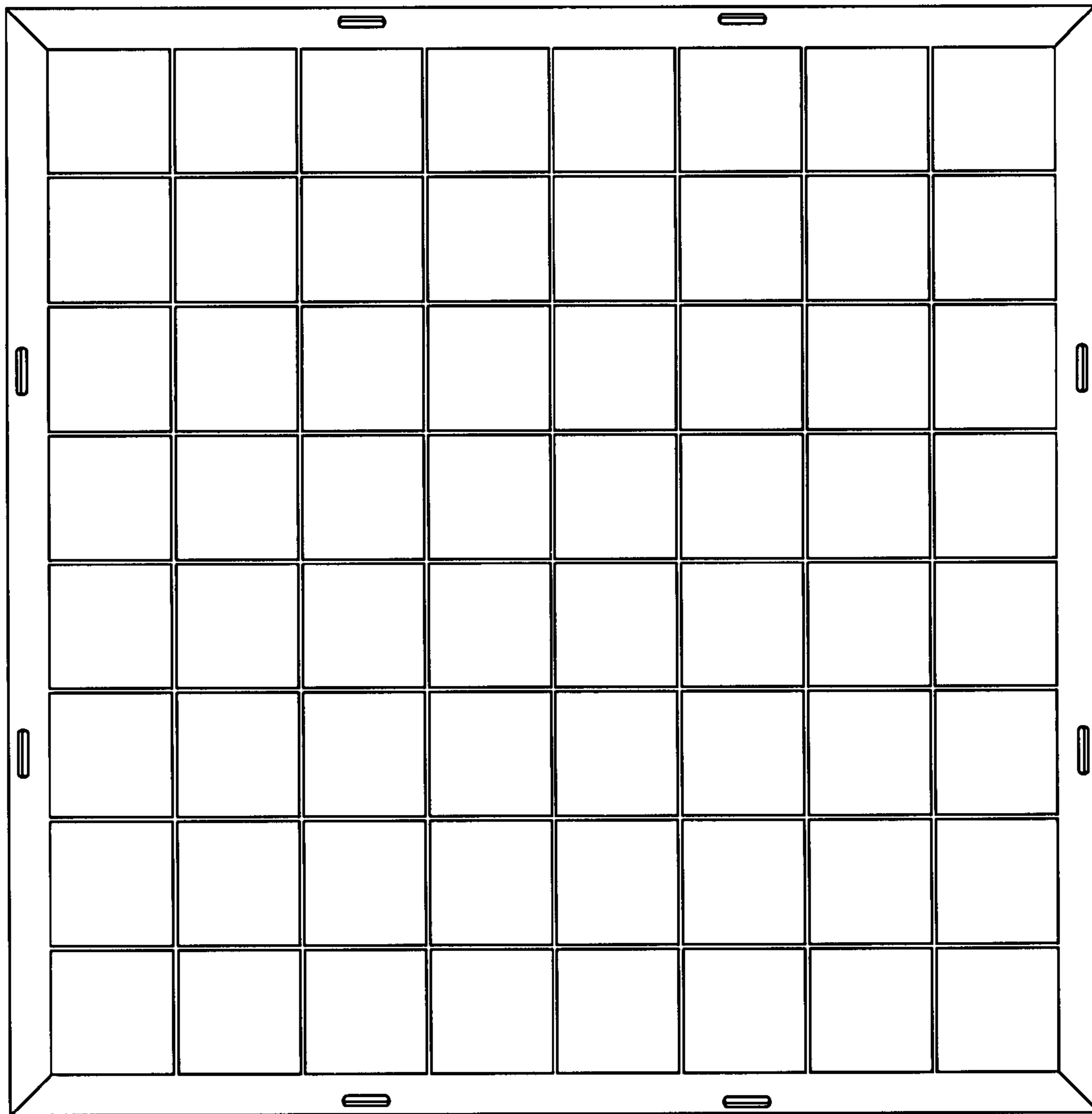
**Fig. 4**



**Fig. 5**



**Fig. 6**



**Fig. 7**

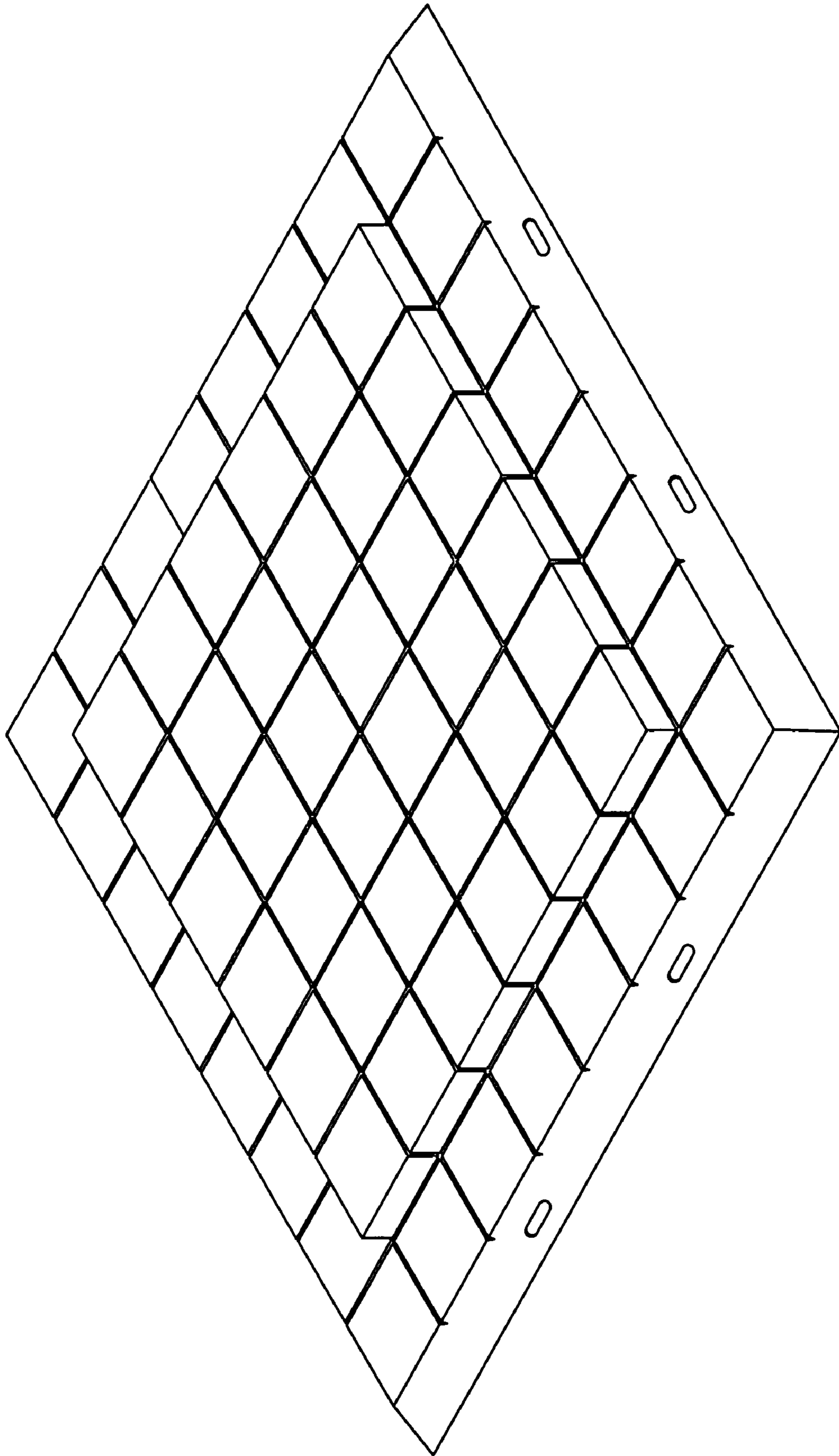


Fig. 8



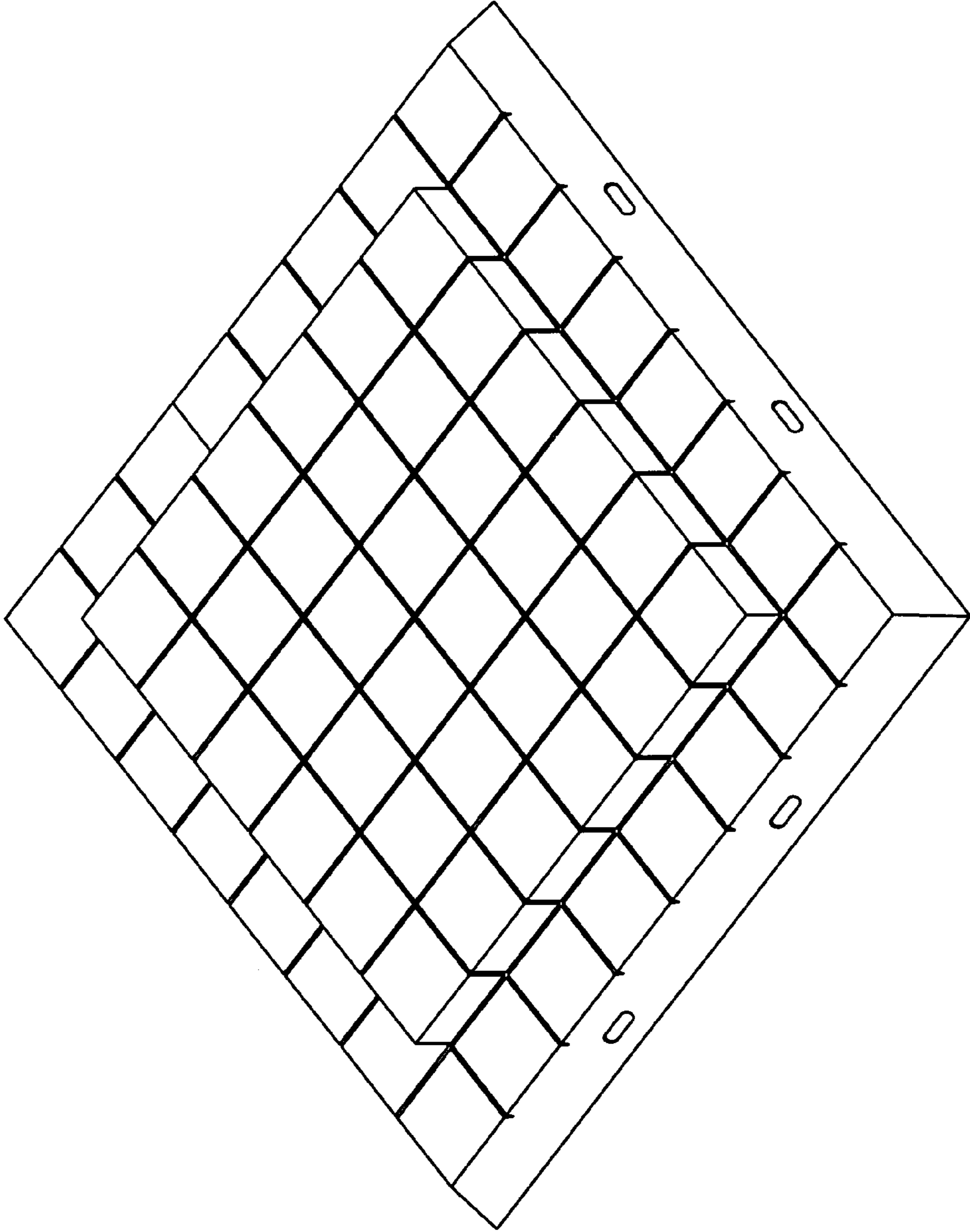


Fig. 9

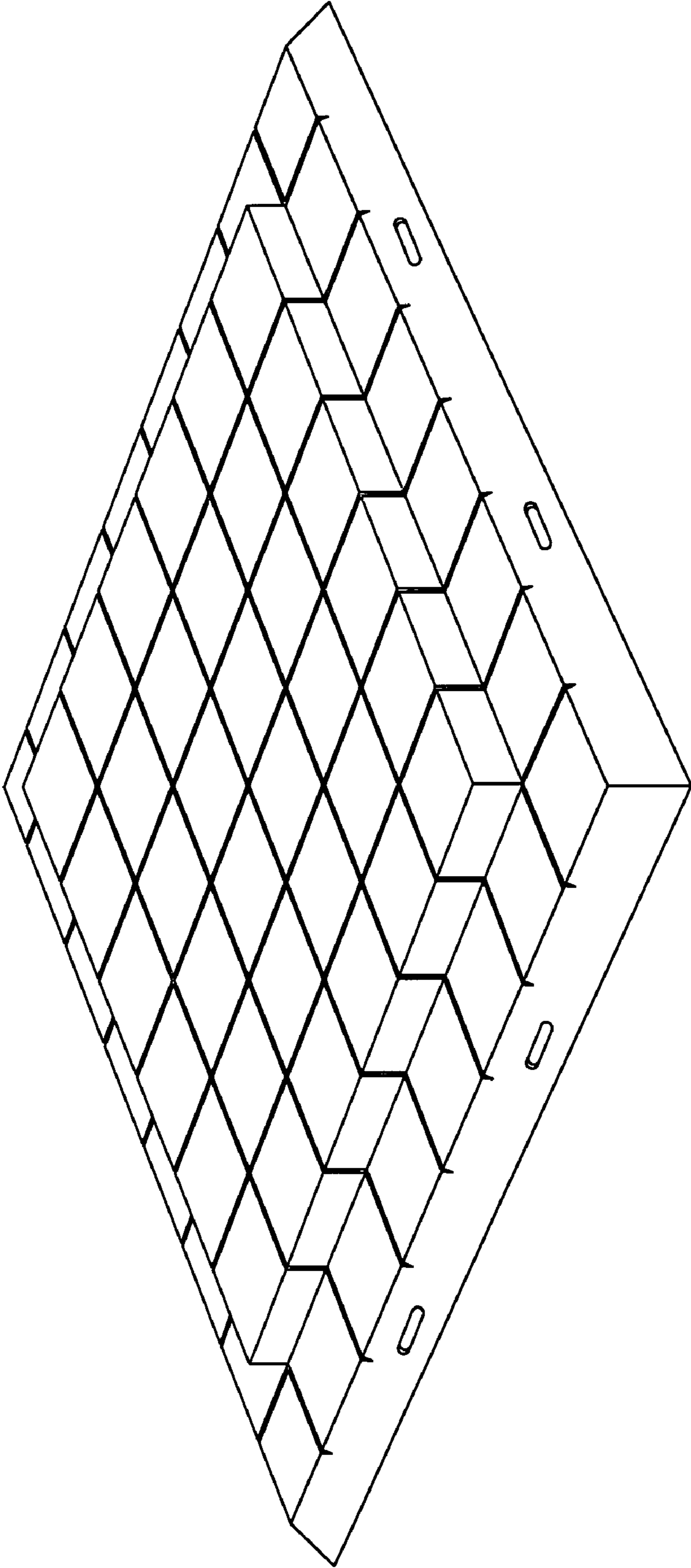


Fig. 10

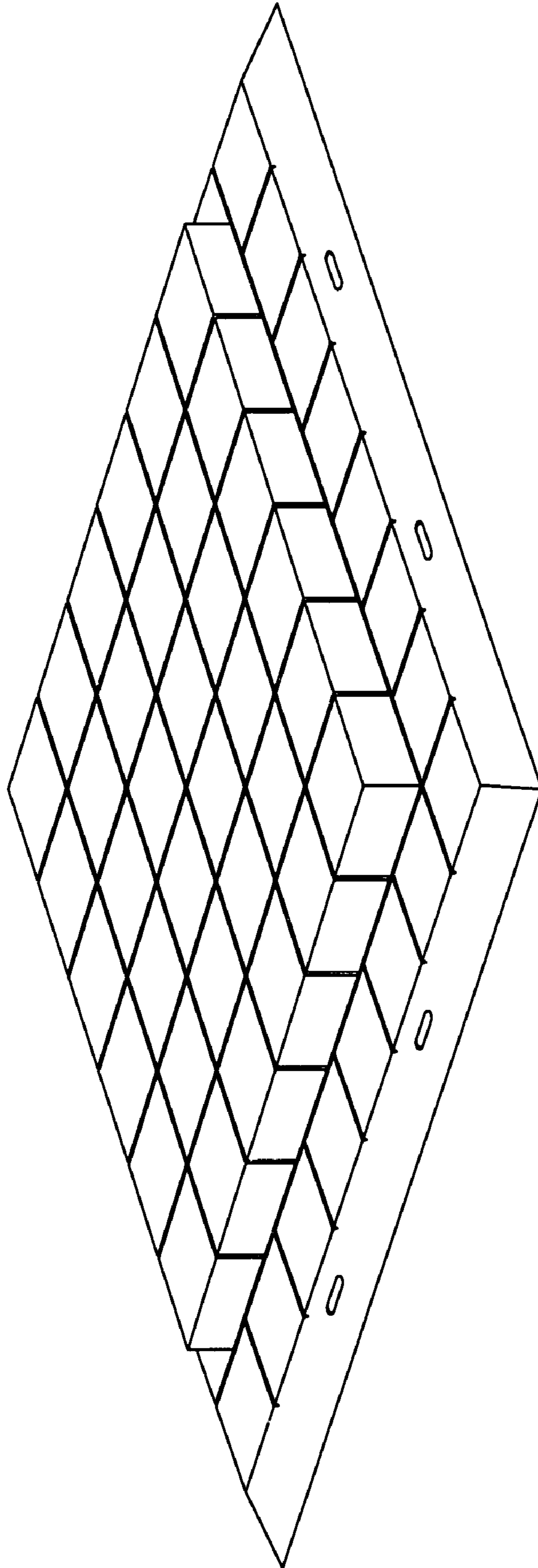


Fig. 11

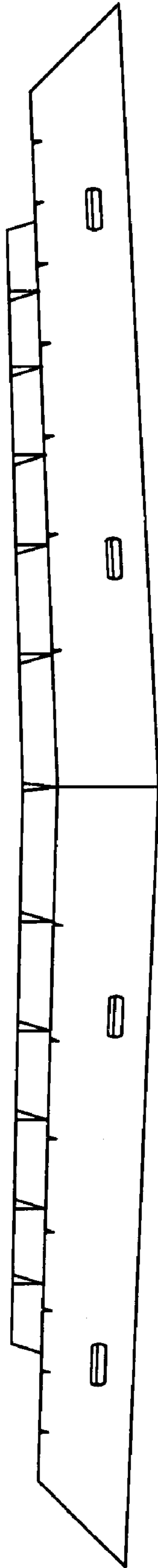


Fig. 12

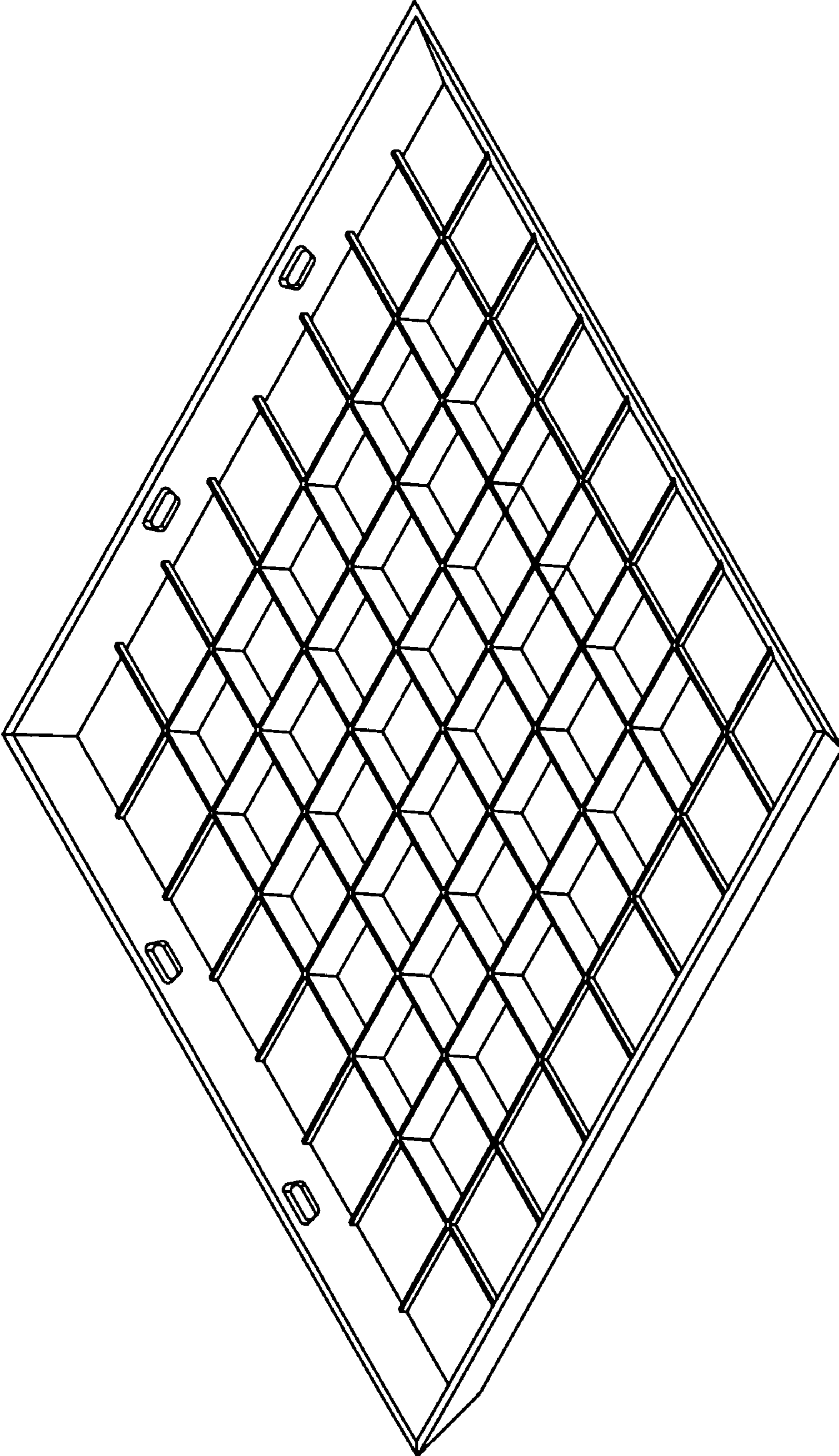
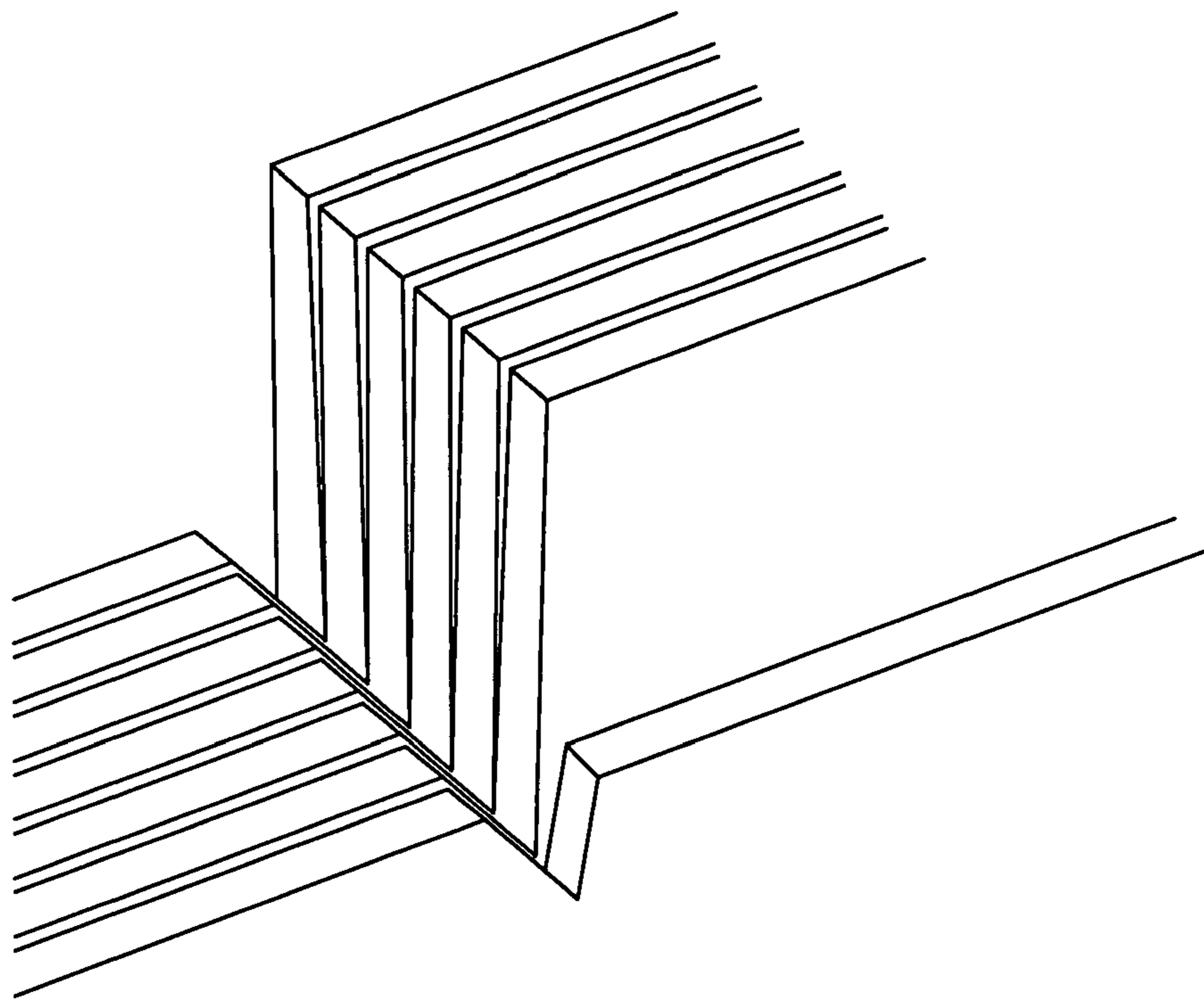
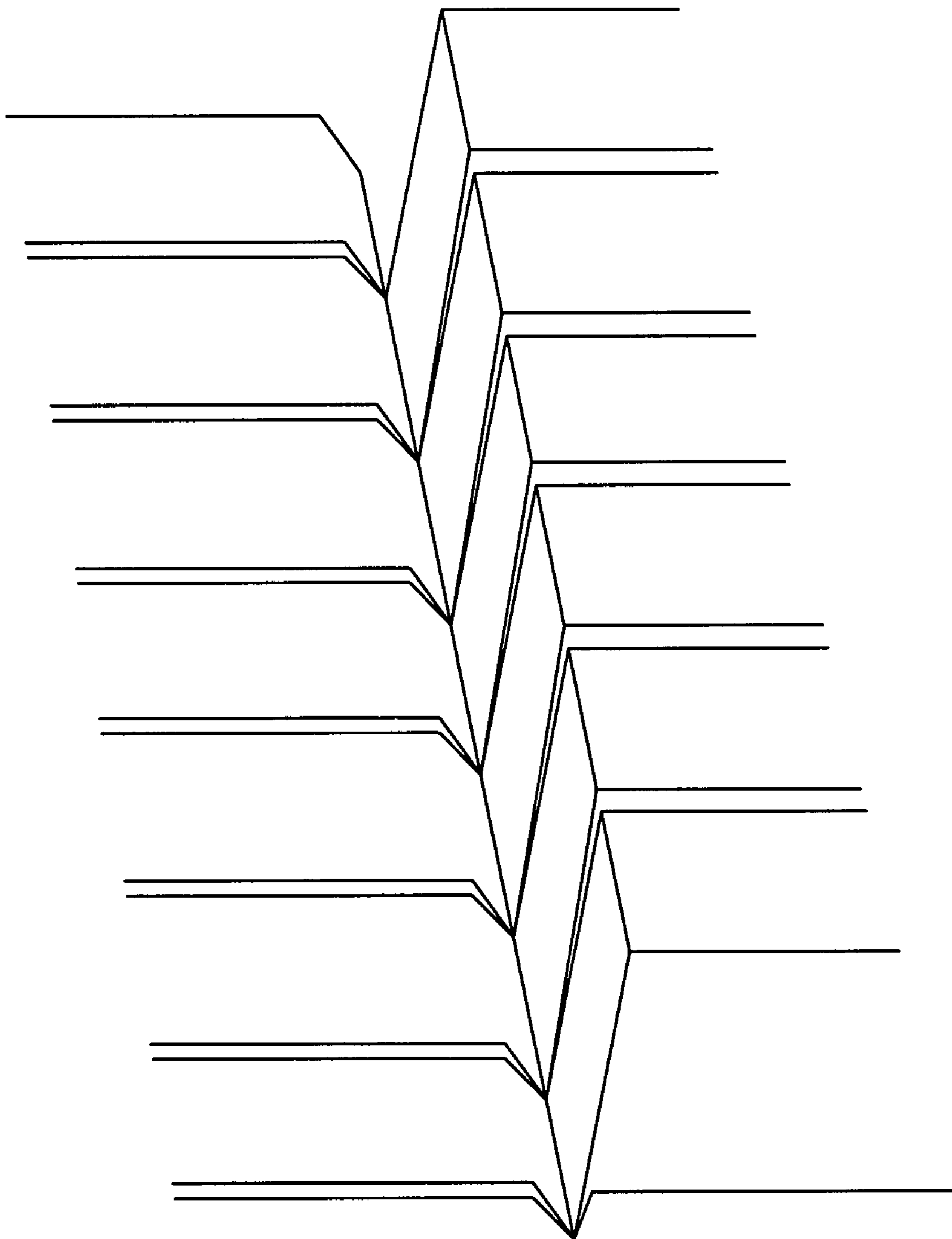


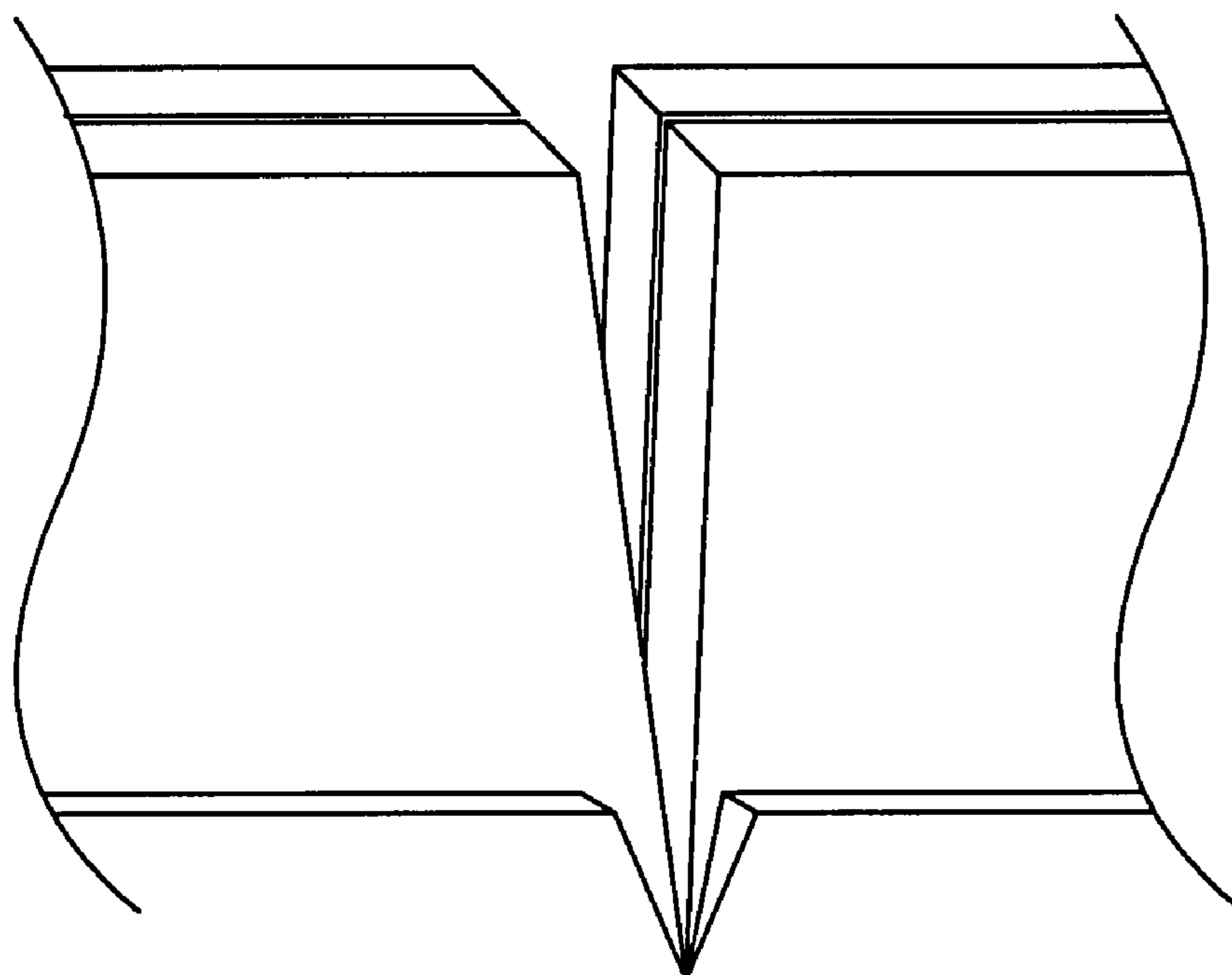
Fig. 13



**Fig. 14**



**Fig. 15**



**Fig. 16**