

US00D548767S

(12) **United States Design Patent**  
**Jannard et al.**

(10) **Patent No.:** **US D548,767 S**

(45) **Date of Patent:** **\*\* Aug. 14, 2007**

(54) **EYEGLASS AND EYEGLASS COMPONENTS**

(75) Inventors: **James H. Jannard**, Spieden Island, WA (US); **Hans Karsten Moritz**, Foothill Ranch, CA (US); **Colin Baden**, Irvine, CA (US); **Jamin Jannard**, Ladera Ranch, CA (US)

(73) Assignee: **Oakley, Inc.**, Foothill Ranch, CA (US)

(\*\*) Term: **14 Years**

(21) Appl. No.: **29/236,800**

(22) Filed: **Aug. 22, 2005**

(51) **LOC (8) Cl.** ..... **16-06**

(52) **U.S. Cl.** ..... **D16/309; D16/325; D16/326; D16/336**

(58) **Field of Classification Search** ..... D16/101, D16/130, 300-330, 332-338, 900; D21/190; D24/110.2; 351/41, 47, 51, 52, 61-63, 83, 351/87, 92, 103-111, 114, 117, 119, 121-124, 351/128, 130-132, 136-139, 153, 158; 2/426-432, 2/434-437, 441, 447-449, 12, 87, 174, 452, 2/454; 381/94.1, 327; 455/344  
See application file for complete search history.

(56) **References Cited**

**U.S. PATENT DOCUMENTS**

2,207,705	A *	7/1940	Cox	381/327
D137,753	S	4/1944	Rey	
D146,538	S	4/1947	Gagnon	
D193,028	S	6/1962	Petitto	
D199,150	S	9/1964	Carmichael	
D202,658	S	10/1965	Petitto	
D209,862	S	1/1968	McCracken	
3,665,122	A	5/1972	Weiss	
3,741,635	A	6/1973	Wortman	
3,809,829	A	5/1974	Vignini et al.	
3,883,701	A	5/1975	Delorenzo	

D268,683	S	4/1983	Tenny	
D285,020	S	8/1986	Schmidthaler	
4,773,095	A	9/1988	Zwicker et al.	
4,856,086	A	8/1989	McCullough et al.	
4,882,769	A	11/1989	Gallimore	
4,904,078	A	2/1990	Gorike	
5,020,150	A	5/1991	Shannon et al.	
5,029,216	A	7/1991	Jhabvala et al.	
5,159,639	A	10/1992	Shannon et al.	
D342,080	S *	12/1993	Cargle	D16/309

(Continued)

**OTHER PUBLICATIONS**

U.S. Appl. No. 29/227,719, filed Apr. 13, 2005, Jannard, et al.

(Continued)

*Primary Examiner*—T. Chase Nelson  
*Assistant Examiner*—Barbara Blanton Lohr  
(74) *Attorney, Agent, or Firm*—Gregory K. Nelson

(57) **CLAIM**

The ornamental design for an eyeglass and eyeglass components, as shown and described.

**DESCRIPTION**

FIG. 1 is a front perspective view of the eyeglass and the eyeglass components of the present invention;

FIG. 2 is a front elevational view thereof;

FIG. 3 is a rear elevational view thereof;

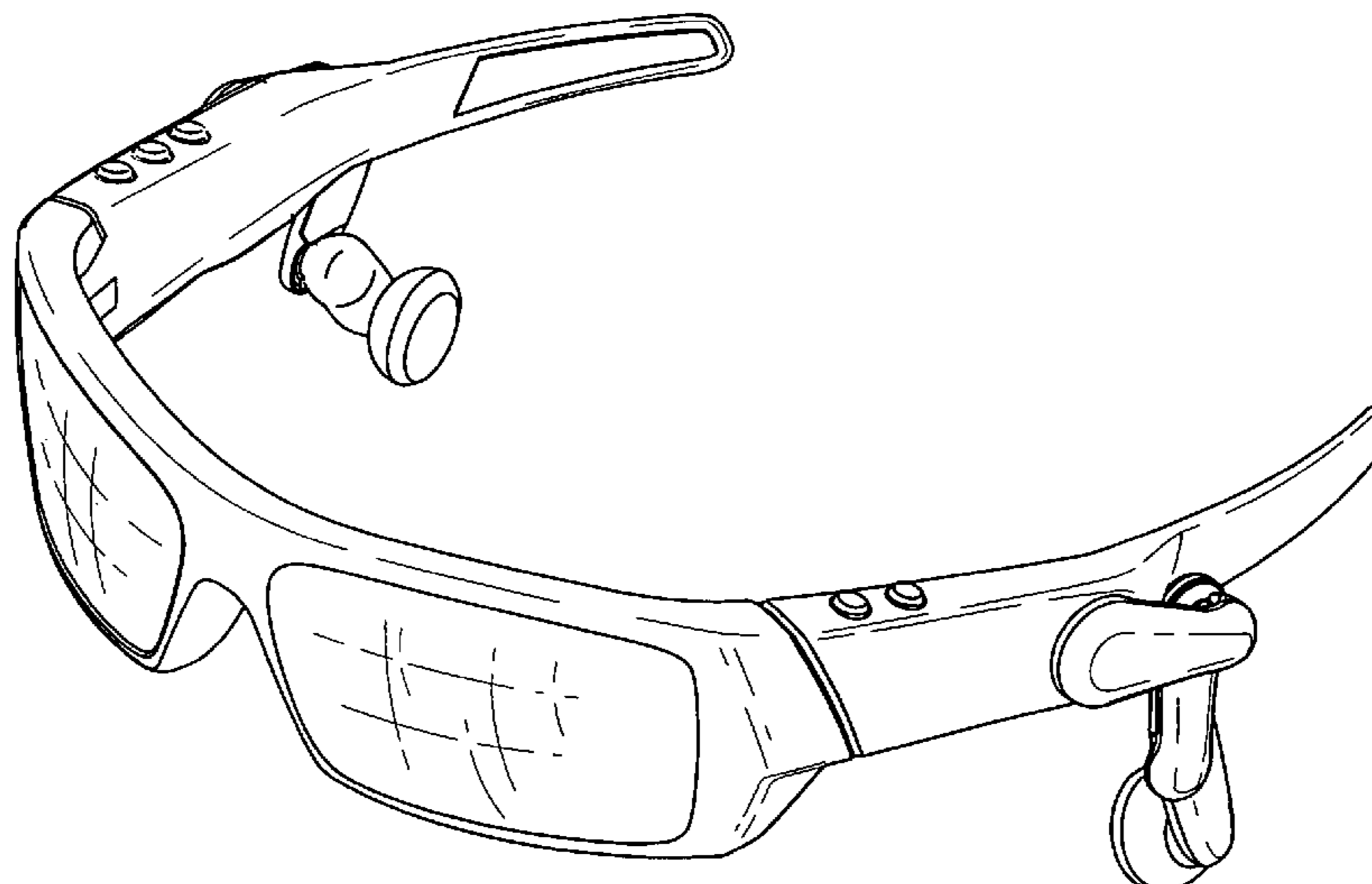
FIG. 4 is a right-side elevational view thereof, the left-side elevational view being a mirror image thereof;

FIG. 5 is a bottom plan view thereof; and,

FIG. 6 is a top plan view thereof.

The phantom lines, where utilized, are for illustrative purposes only and form no part of the claimed design.

**1 Claim, 4 Drawing Sheets**



# US D548,767 S

Page 2

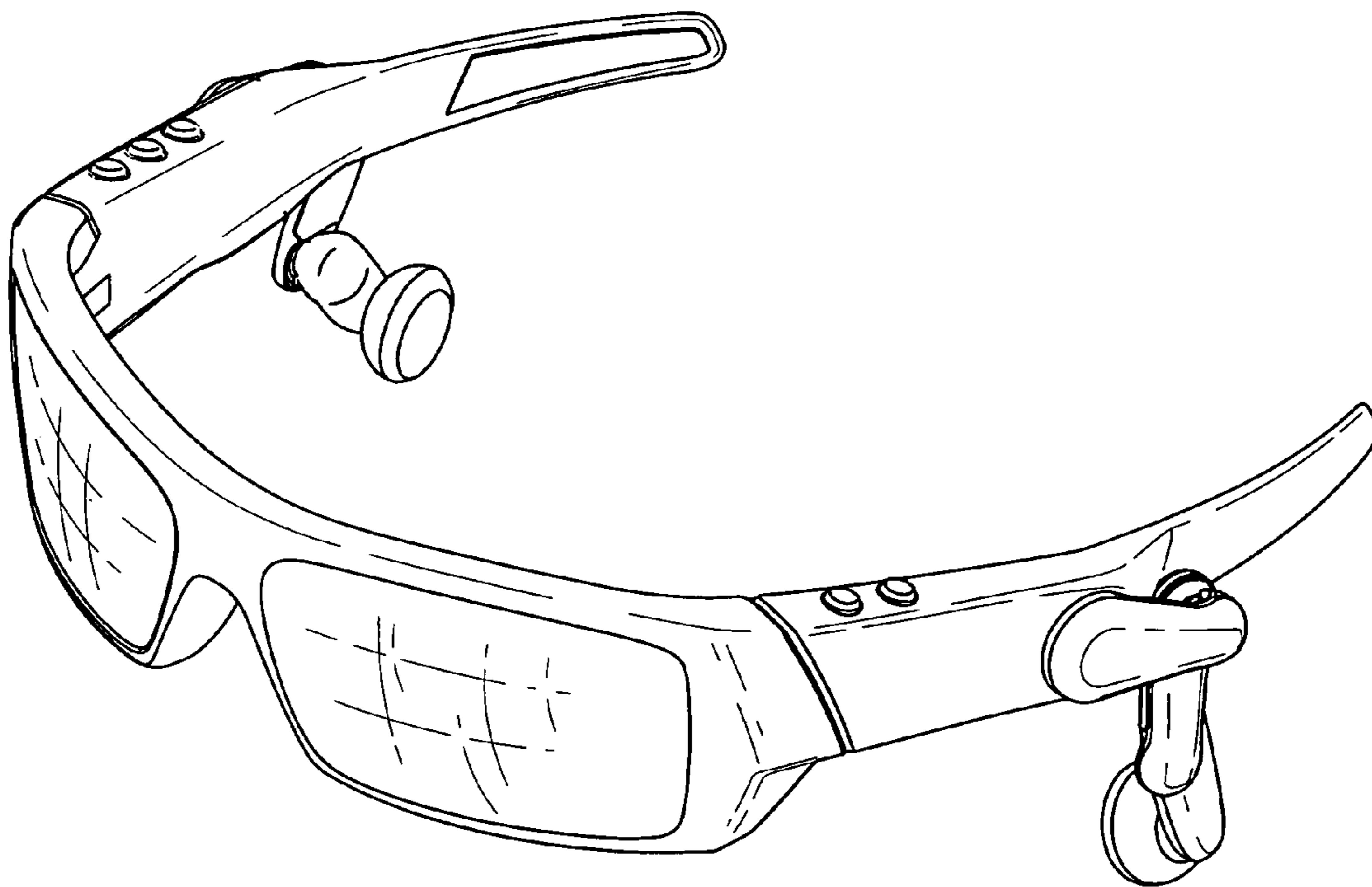
## U.S. PATENT DOCUMENTS

5,281,957	A	1/1994	Schoolman	
5,335,285	A	8/1994	Gluz	
D352,300	S *	11/1994	Gales .....	D16/309
5,367,345	A	11/1994	da Silva	
D353,387	S *	12/1994	Peters .....	D16/309
D371,383	S	7/1996	Goldman	
D372,726	S	8/1996	Simioni	
5,579,400	A	11/1996	Ballein	
5,606,743	A	2/1997	Vogt et al.	
5,608,808	A	3/1997	da Silva	
D381,346	S *	7/1997	Ronzani et al. ....	D16/130
5,694,475	A	12/1997	Boyden	
D390,589	S	2/1998	Simioni	
5,715,323	A	2/1998	Walker	
5,717,479	A	2/1998	Rickards	
5,737,436	A	4/1998	Boyden	
D397,351	S	8/1998	Simioni	
D399,243	S *	10/1998	Jannard et al. ....	D16/335
D407,099	S	3/1999	Wang	
D414,796	S	10/1999	Arnette	
6,010,216	A	1/2000	Jesiek	
6,012,812	A	1/2000	Richards	
6,091,546	A	7/2000	Spitzer	
6,091,832	A	7/2000	Shurman et al.	
6,176,576	B1 *	1/2001	Green et al. ....	351/123
D445,416	S	7/2001	Glezerman	
6,272,359	B1	8/2001	Kivela et al.	
6,301,050	B1	10/2001	DeLeon	
6,301,367	B1	10/2001	Boyden et al.	
6,421,031	B1	7/2002	Ronzani et al.	
D461,834	S *	8/2002	Jannard et al. ....	D16/326
D462,708	S *	9/2002	Miller et al. ....	D16/309
6,456,721	B1	9/2002	Fukuda	
D464,669	S *	10/2002	Thixton et al. ....	D16/326
6,690,805	B1 *	2/2004	Tsuji et al. ....	381/94.1
D514,613	S *	2/2006	Jannard et al. ....	D16/309
D523,461	S *	6/2006	Jannard et al. ....	D16/309
2002/0098877	A1	7/2002	Glezerman	
2002/0197961	A1	12/2002	Warren	
2003/0022690	A1	1/2003	Beyda et al.	
2003/0068057	A1	4/2003	Miller et al.	
2004/0000733	A1	1/2004	Swab et al.	
2004/0132509	A1	7/2004	Glezerman	
2004/0239874	A1	12/2004	Swab et al.	

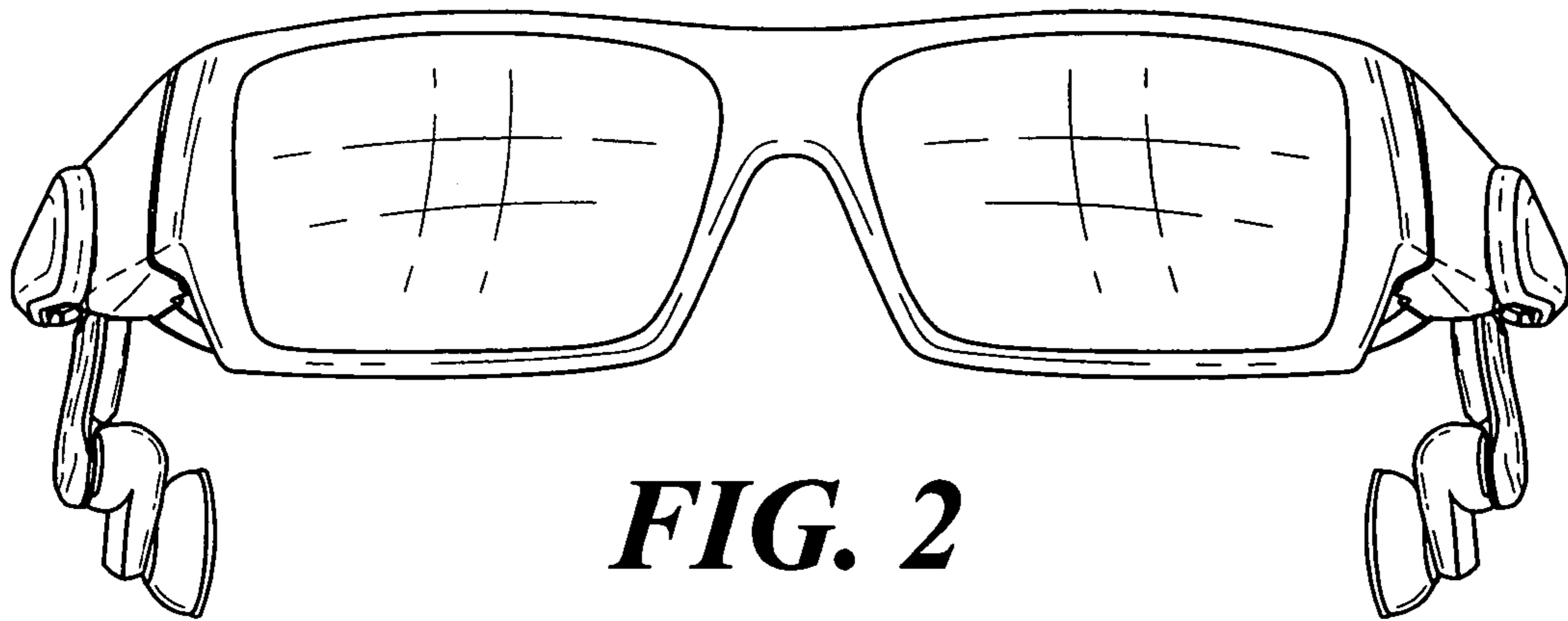
## OTHER PUBLICATIONS

U.S. Appl. No. 29/227,304, filed Apr. 7, 2005, Jannard, et al.  
U.S. Appl. No. 29/218,487, filed Dec. 2, 2004, Jannard, et al.  
Oakley, Inc., Oakley Official Eyewear Catalog 2003/2004, Oakley, Inc., published May 2003, Foothill Ranch, California.

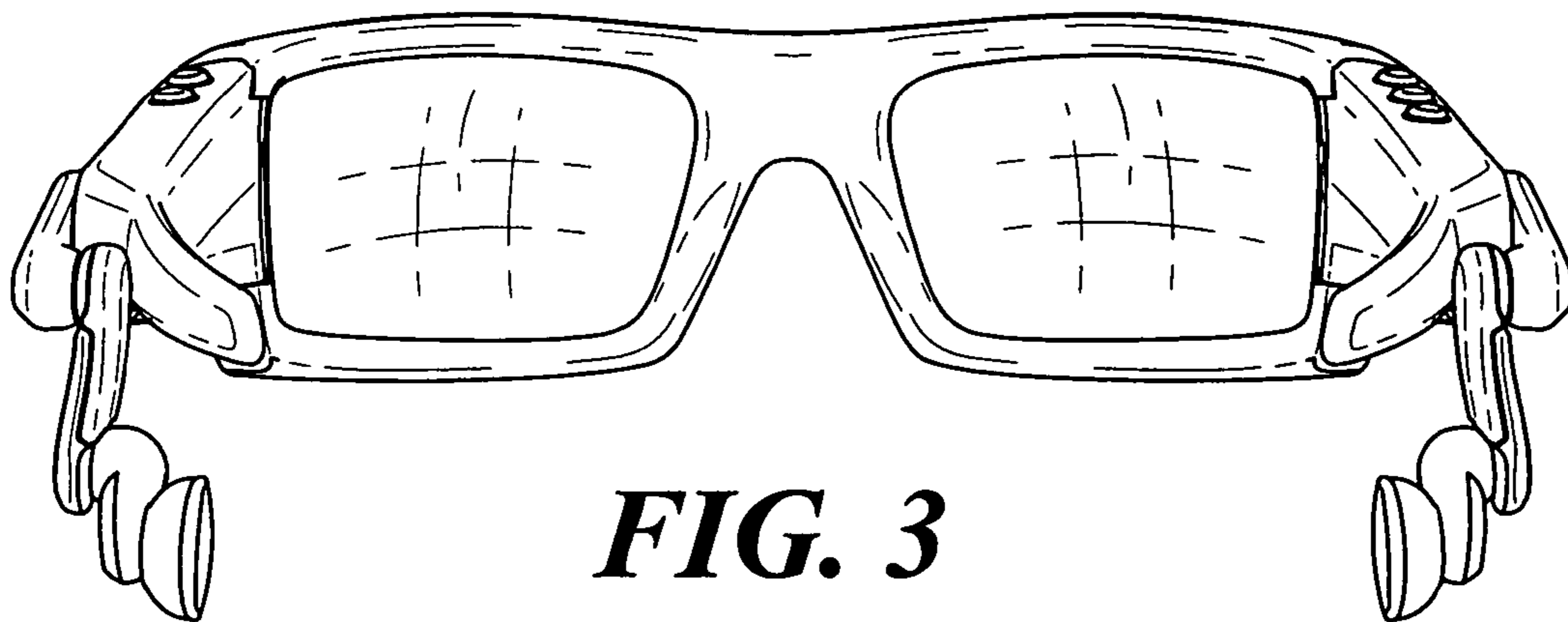
\* cited by examiner



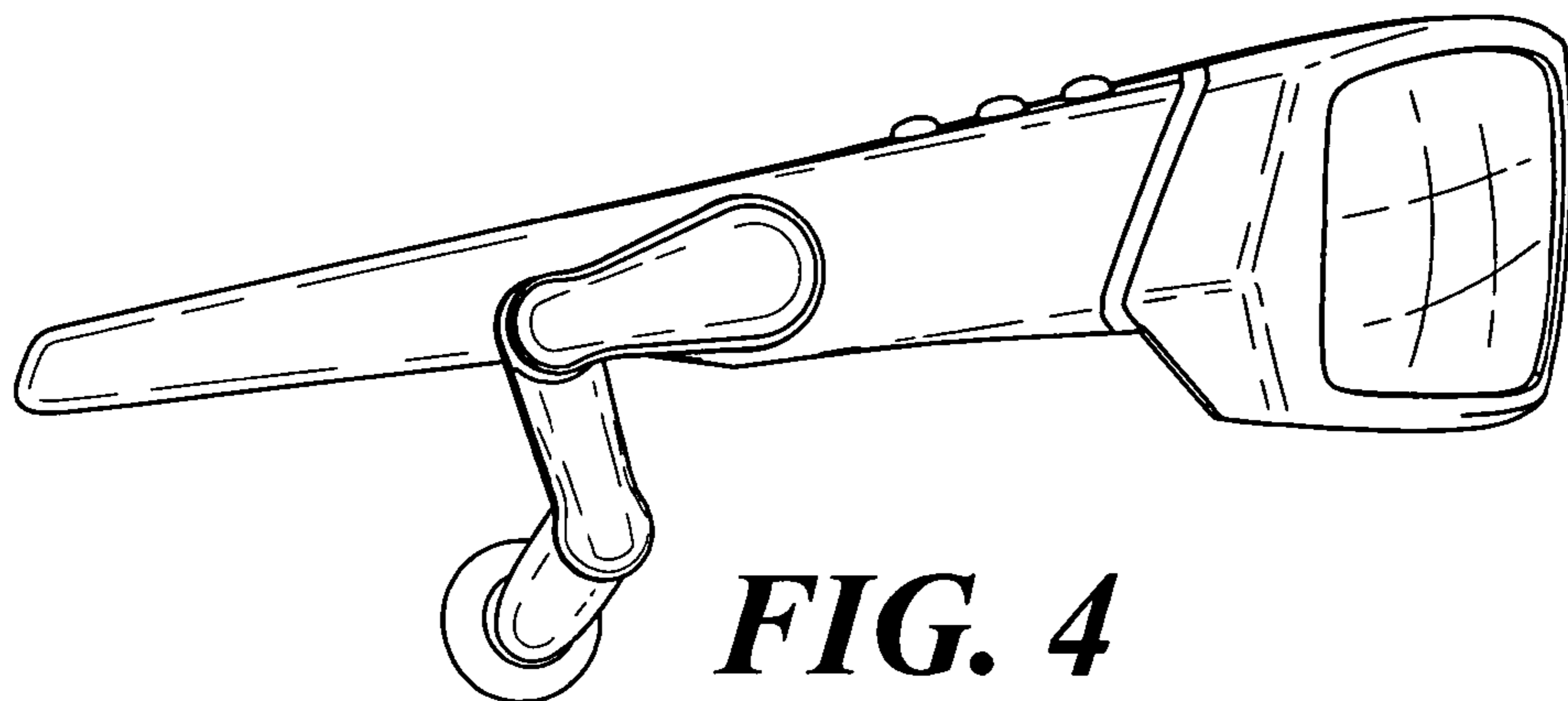
**FIG. 1**



**FIG. 2**

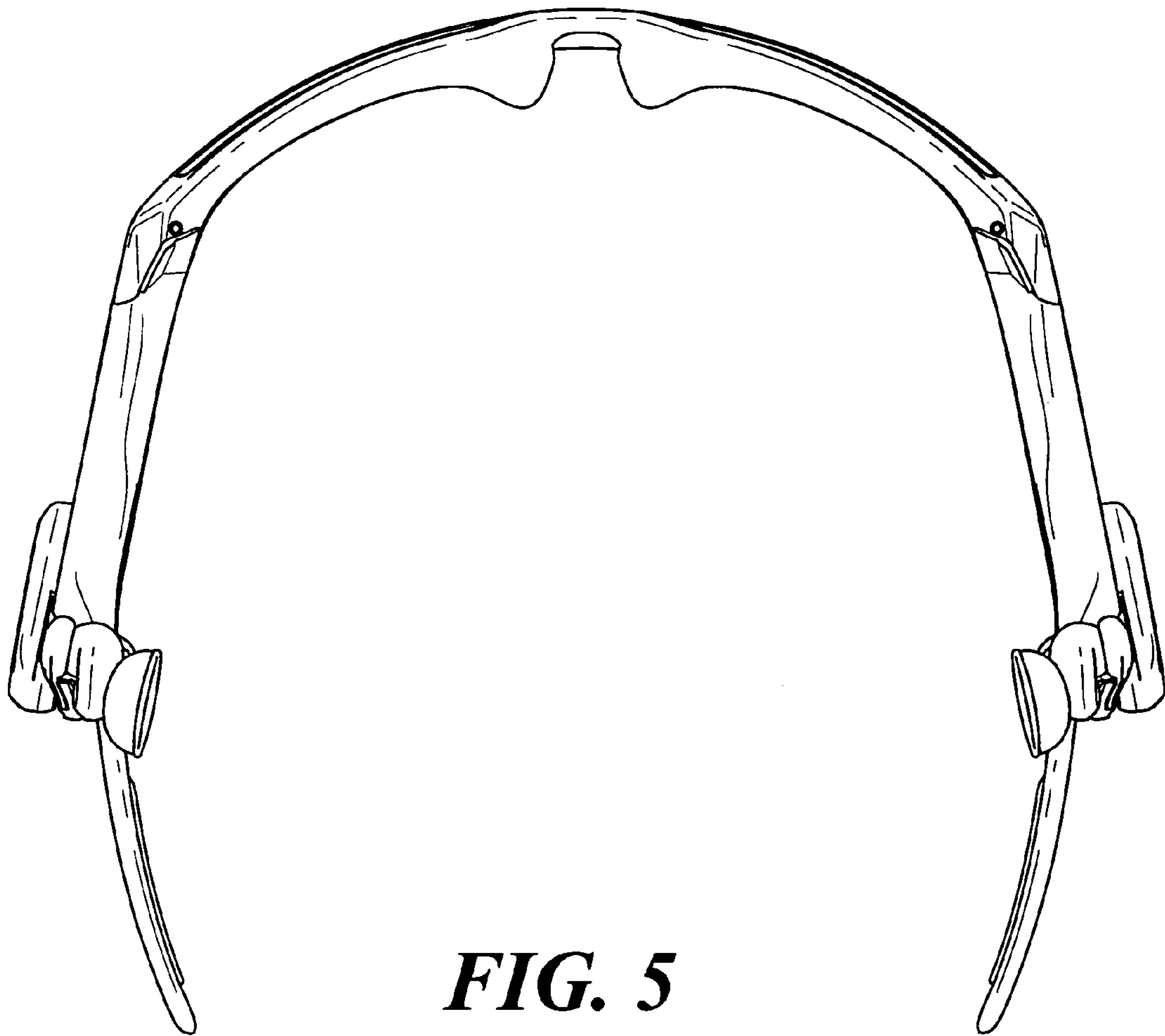


**FIG. 3**

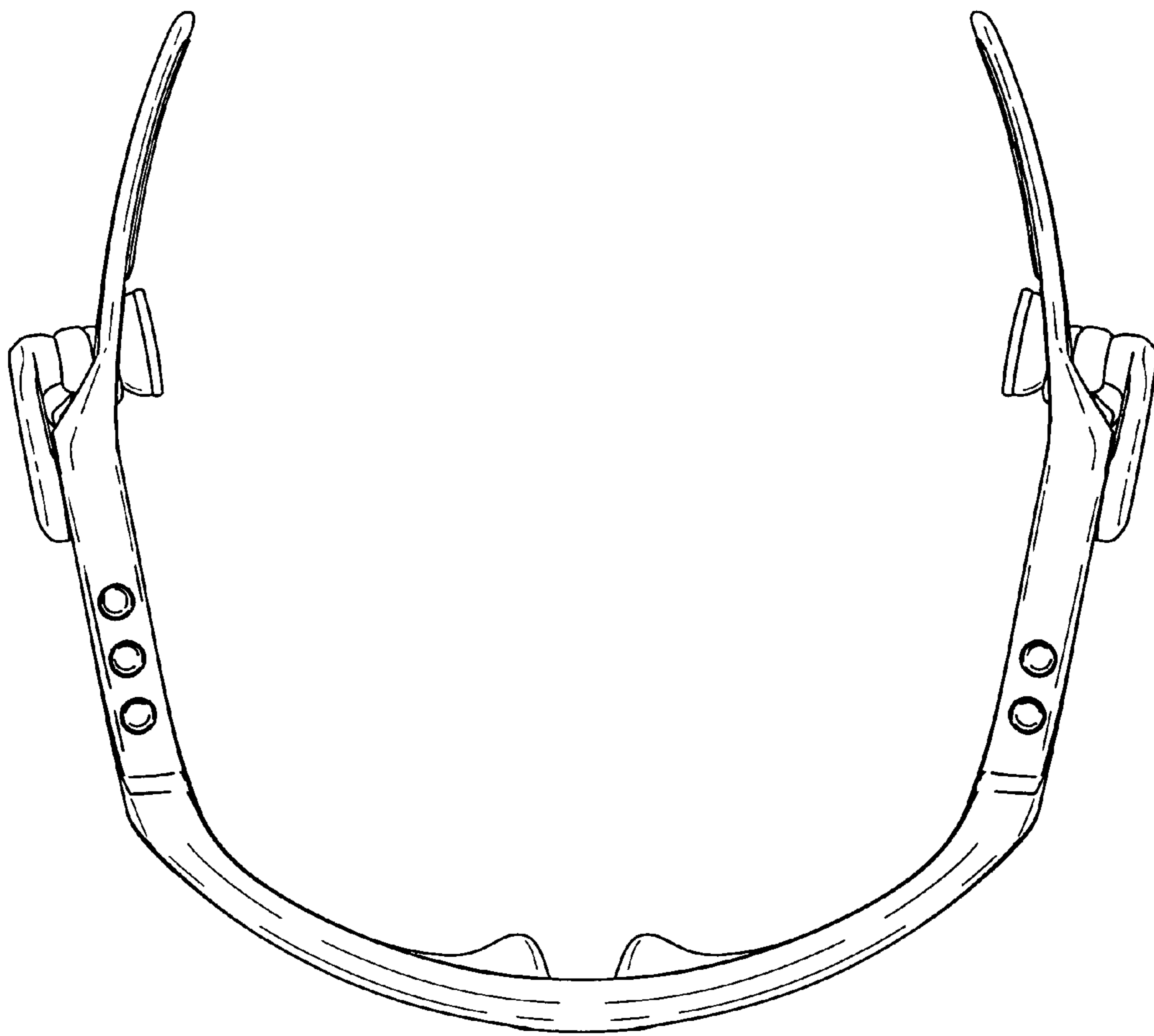


**FIG. 4**





***FIG. 5***



**FIG. 6**