



US00D548733S

(12) **United States Design Patent**
Johansson

(10) **Patent No.:** **US D548,733 S**

(45) **Date of Patent:** **** Aug. 14, 2007**

(54) **INTERNET DEVICE**

(75) Inventor: **Panu Johansson**, Tampere (FI)

(73) Assignee: **Nokia Corporation**, Espoo (FI)

(**) Term: **14 Years**

(21) Appl. No.: **29/238,815**

(22) Filed: **Sep. 22, 2005**

(30) **Foreign Application Priority Data**

Mar. 23, 2005 (FI) M20050049

(51) **LOC (8) Cl.** **14-02**

(52) **U.S. Cl.** **D14/341**

(58) **Field of Classification Search** D14/336-346,
D14/125-129; D19/26, 59, 60; 345/104,
345/156, 168, 173; 178/18.03; 349/12;
434/307 R, 308, 309, 317; 340/825.52; 709/200,
709/202, 217, 218, 249

See application file for complete search history.

(56) **References Cited**

U.S. PATENT DOCUMENTS

5,964,830	A *	10/1999	Durrett	709/200
D417,201	S *	11/1999	Davis	D14/343
D432,124	S *	10/2000	Pardikes et al.	D14/336
D437,593	S *	2/2001	Keeler et al.	D14/336
D463,420	S *	9/2002	Stener et al.	D14/336
D464,646	S *	10/2002	Lin	D14/341
D504,890	S *	5/2005	Sung et al.	D14/346
2003/0103041	A1 *	6/2003	Nguyen et al.	345/168

* cited by examiner

Primary Examiner—Freda S. Nunn

(74) *Attorney, Agent, or Firm*—Banner & Witcoff, Ltd.

(57) **CLAIM**

The ornamental design of an internet device, as shown and described.

DESCRIPTION

FIG. 1 is a front view of an internet device showing my new design; and

FIG. 2 is a rear view thereof;

FIG. 3 is a perspective front view thereof;

FIG. 4 is a perspective rear view thereof;

FIG. 5 is a bottom plan view thereof;

FIG. 6 is a top plan view thereof;

FIG. 7 is a right side view thereof;

FIG. 8 is a left side view thereof;

FIG. 9 is a front view of the internet device of FIGS. 1-8 in an in-use position;

FIG. 10 is a front view of the internet device of FIGS. 1-8 in an alternative in-use position;

FIG. 11 is a front view of the internet device showing my new design with a cover removed;

FIG. 12 is a rear view thereof;

FIG. 13 is a perspective front view thereof;

FIG. 14 is a perspective rear view thereof;

FIG. 15 is a bottom plan view thereof;

FIG. 16 is a top plan view thereof;

FIG. 17 is a right side view thereof; and,

FIG. 18 is left side view thereof.

The broken lines showing various regions in the Figures are for illustrative purposes only and form no part of the claimed design.

1 Claim, 10 Drawing Sheets

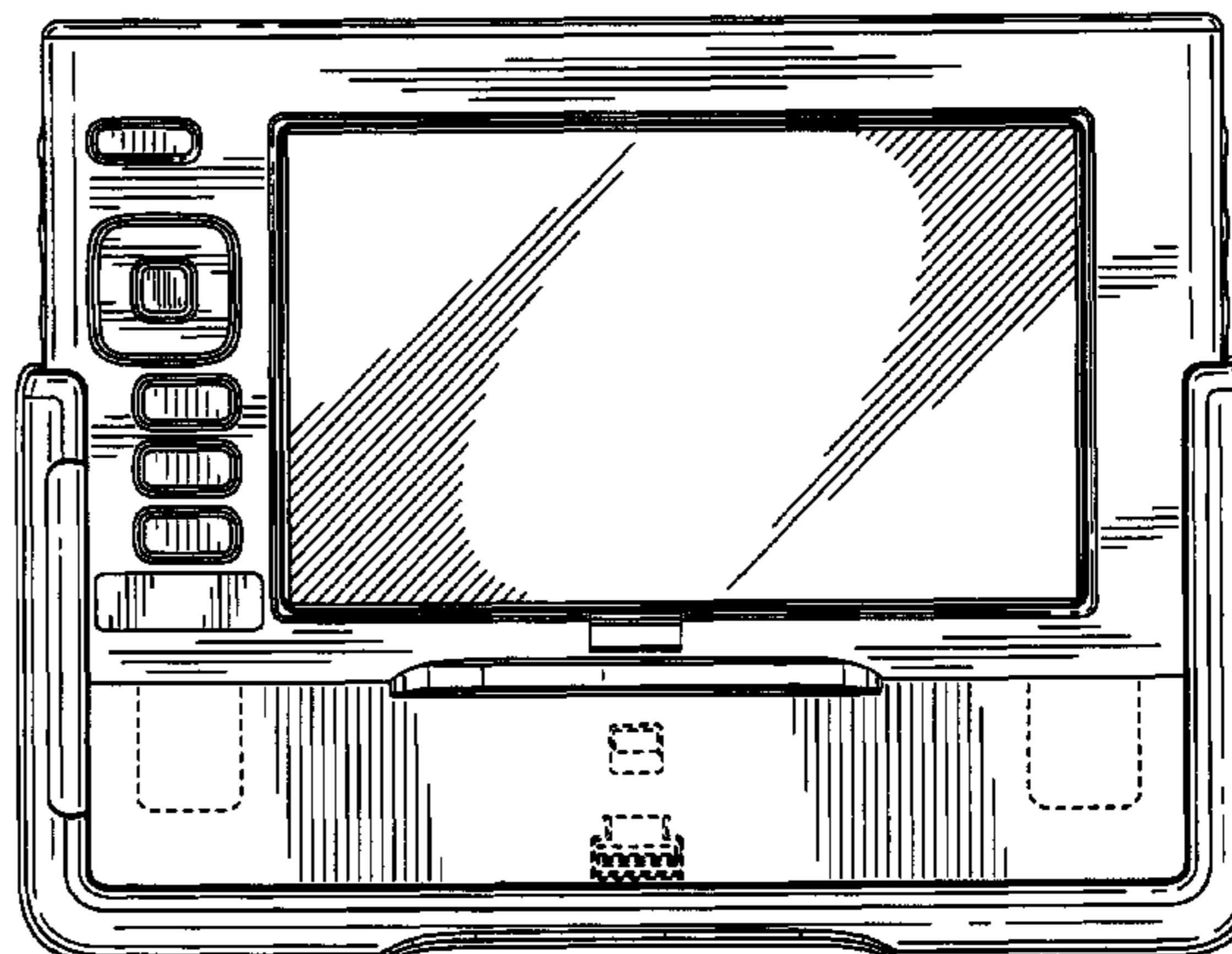
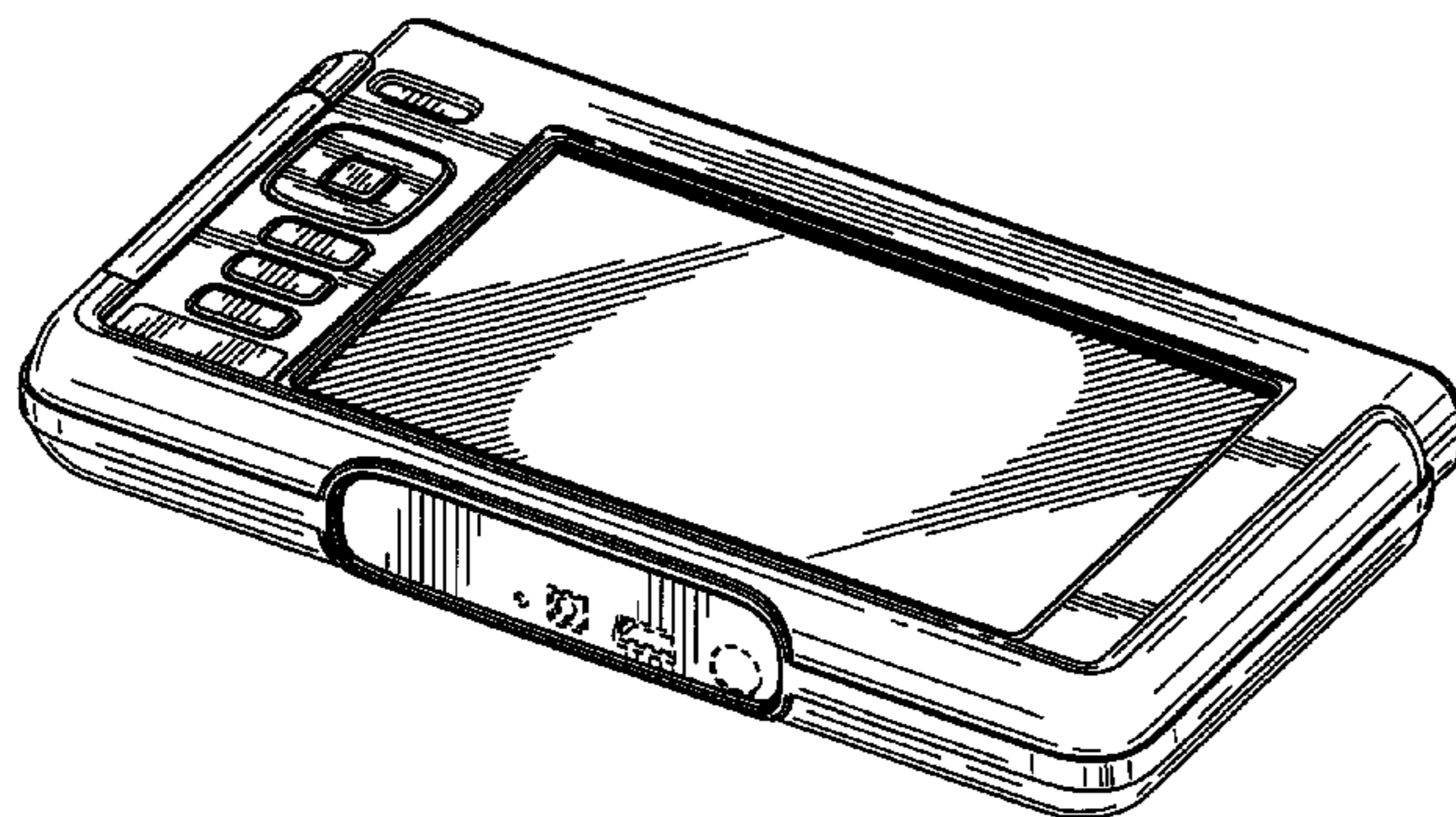

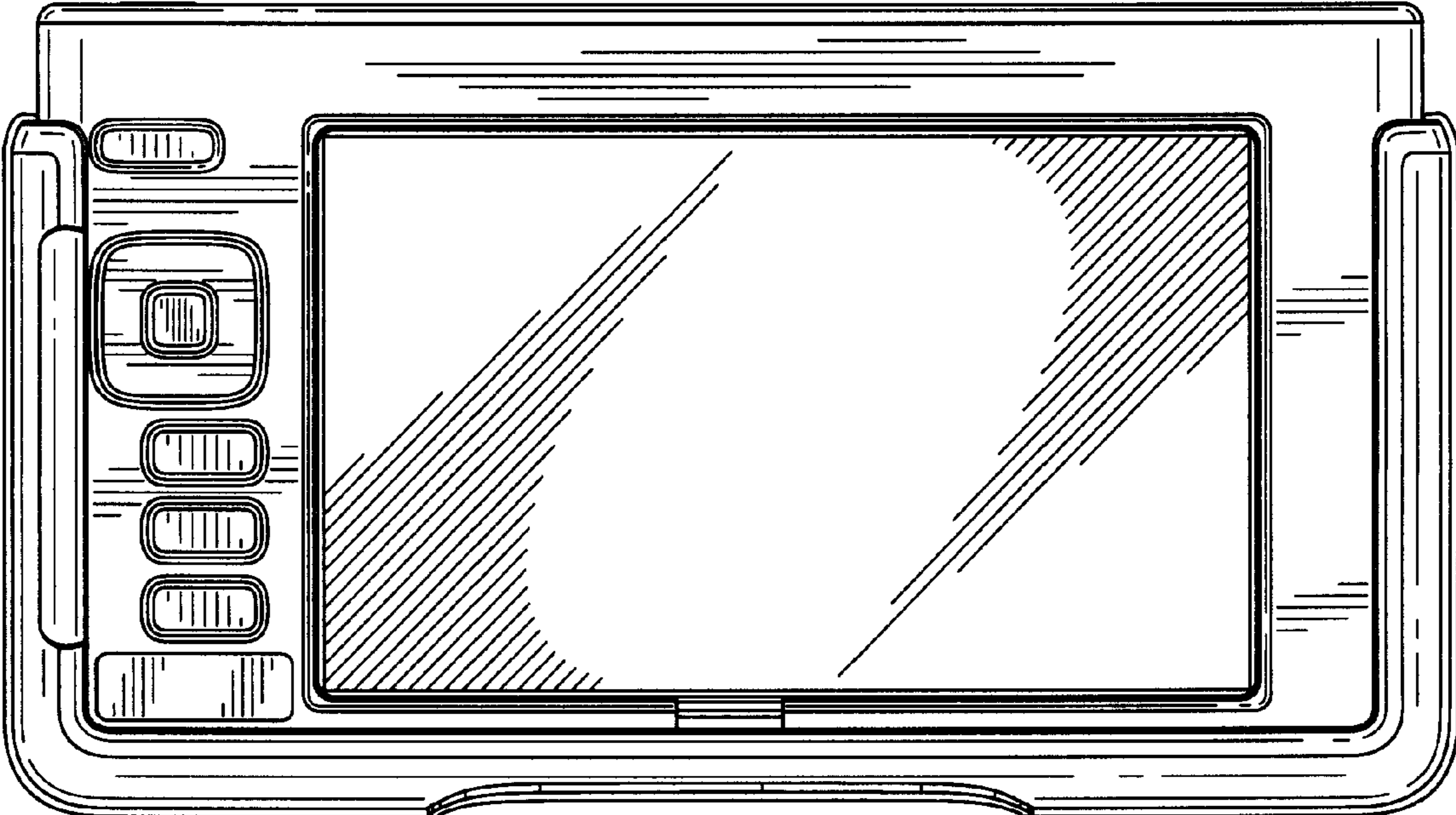

FIG. 1

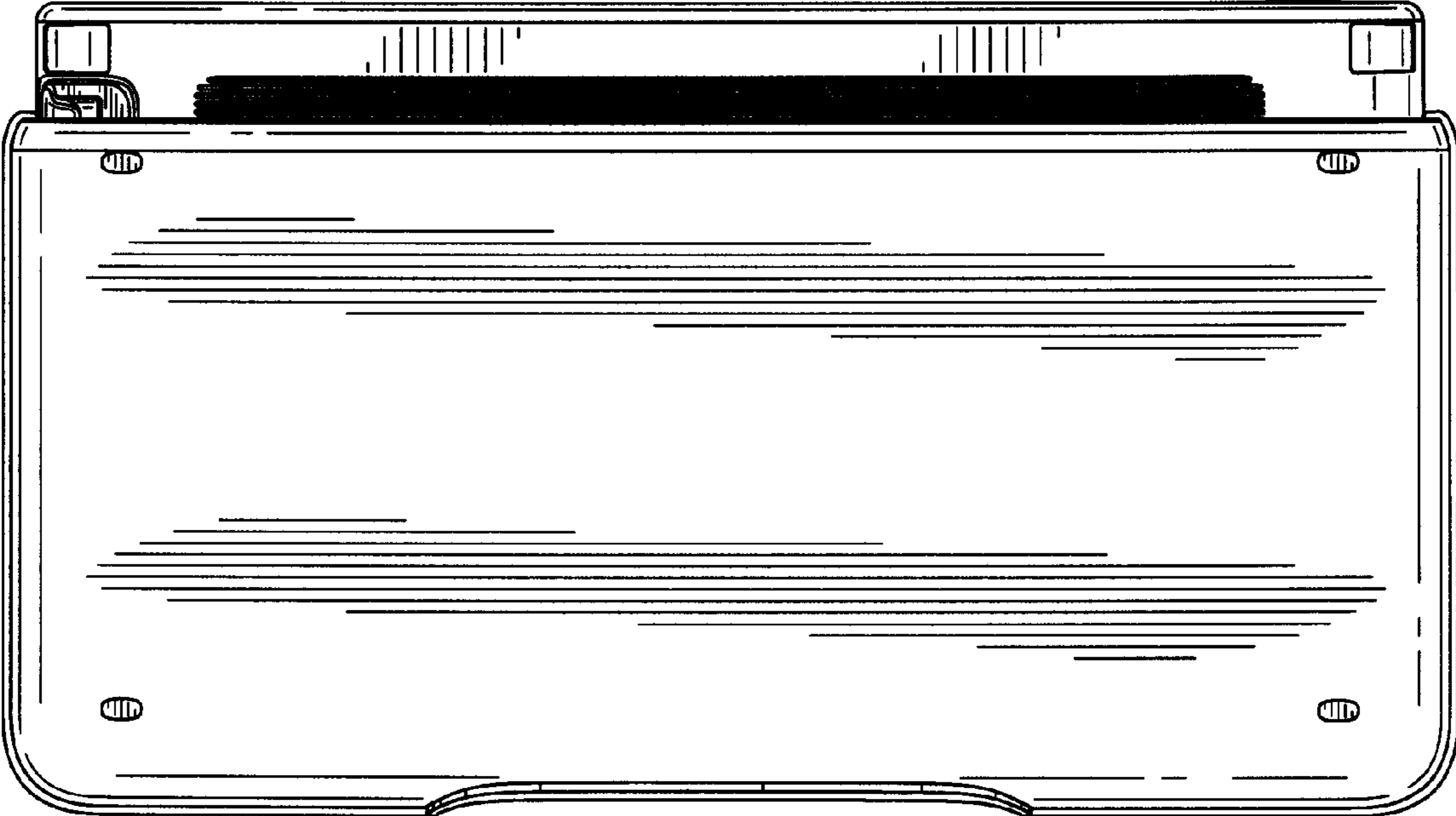

FIG. 2

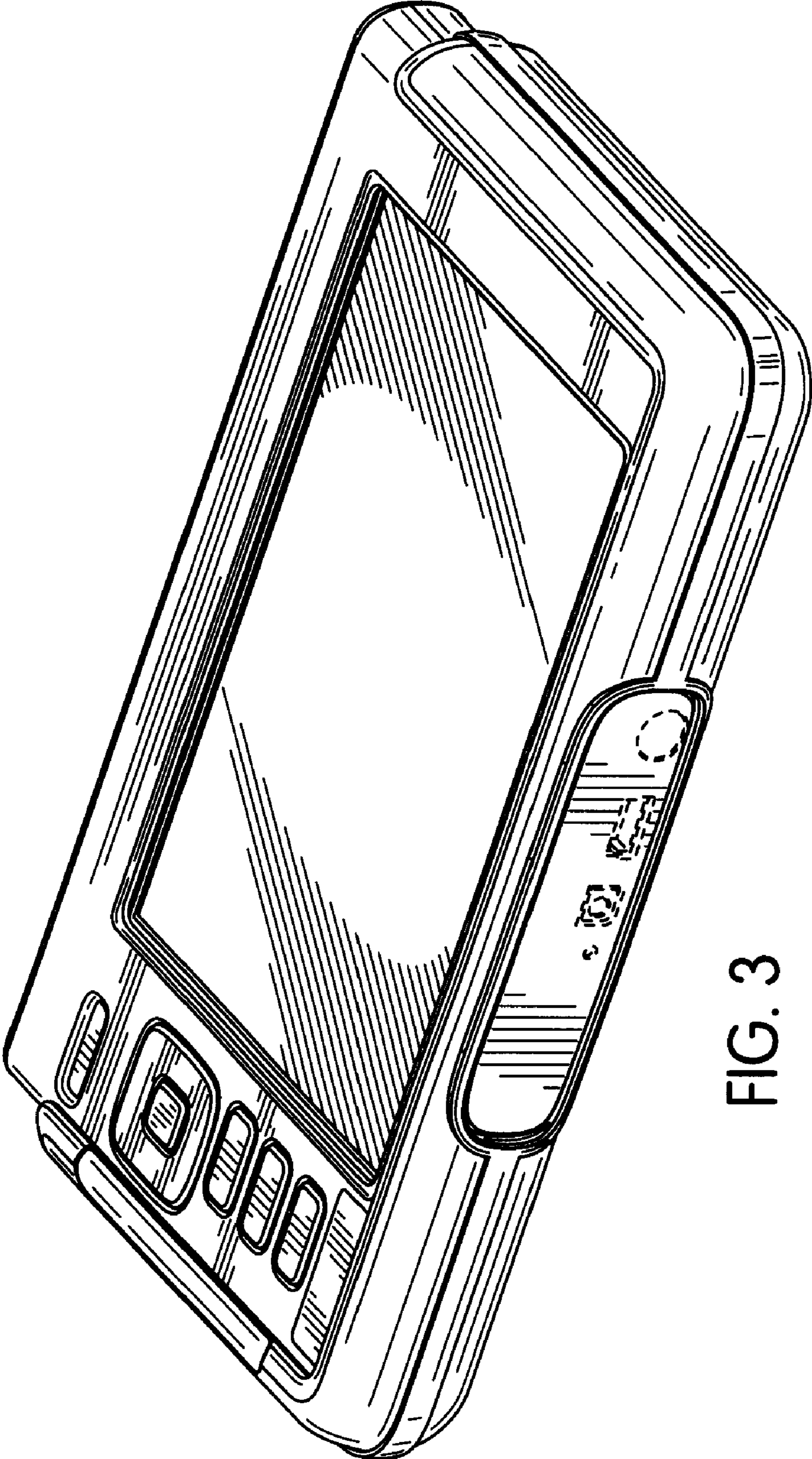

FIG. 3

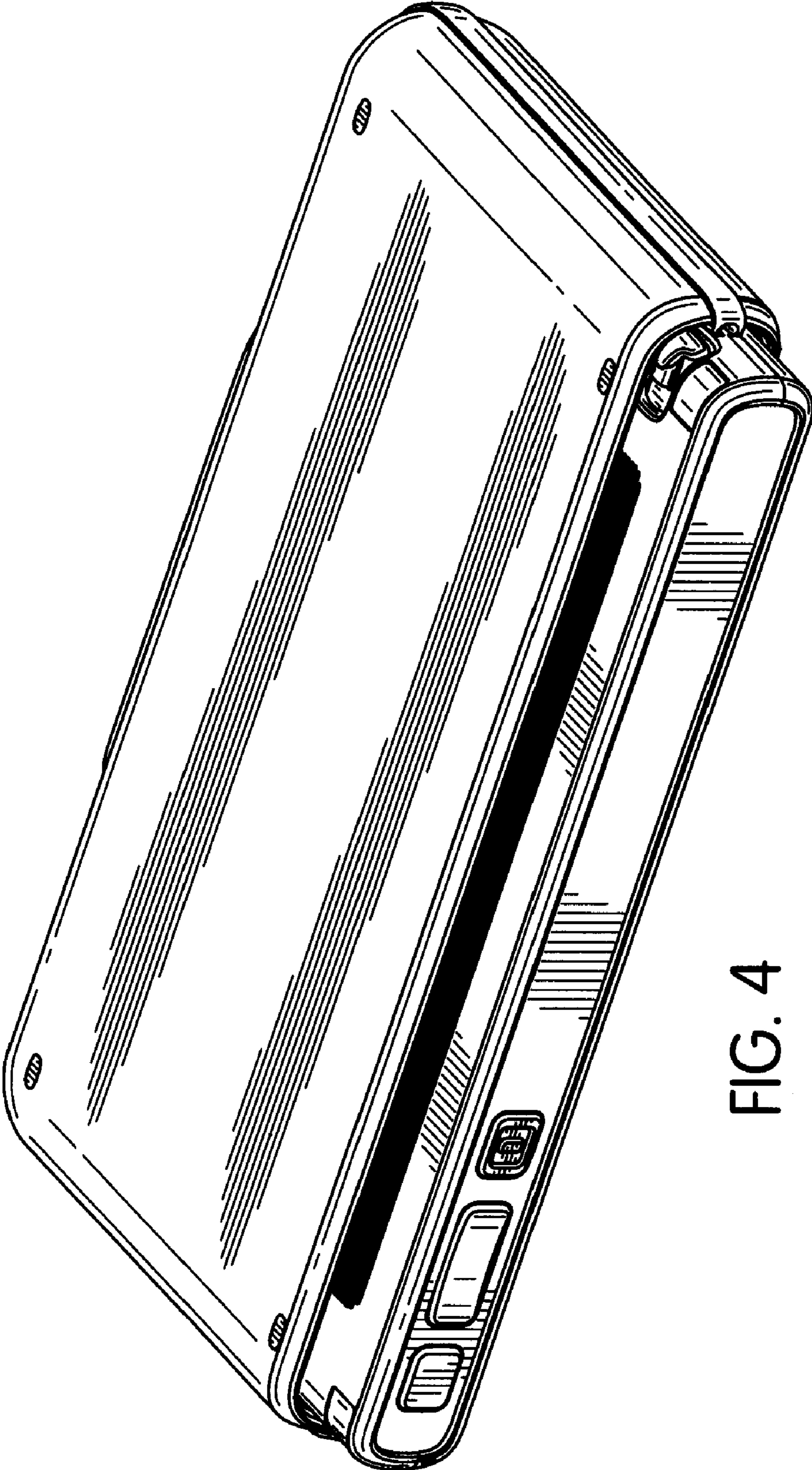

FIG. 4

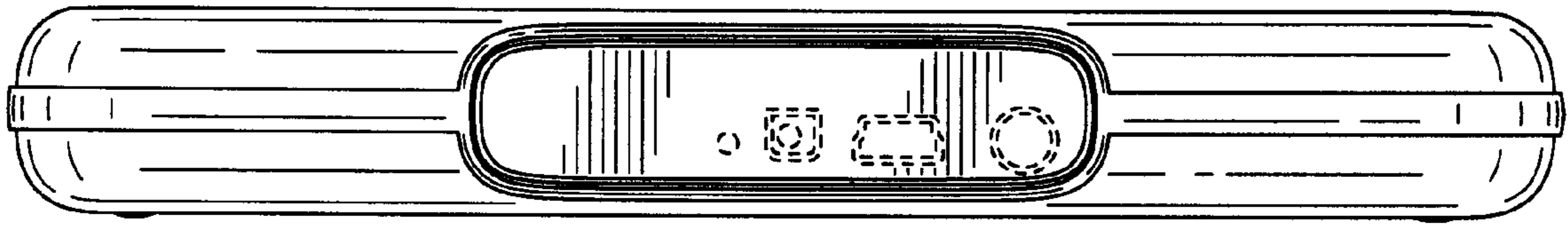

FIG. 5

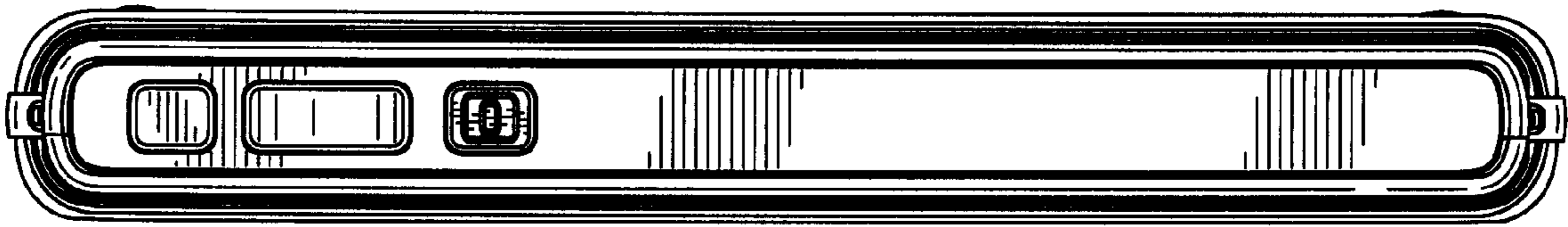

FIG. 6

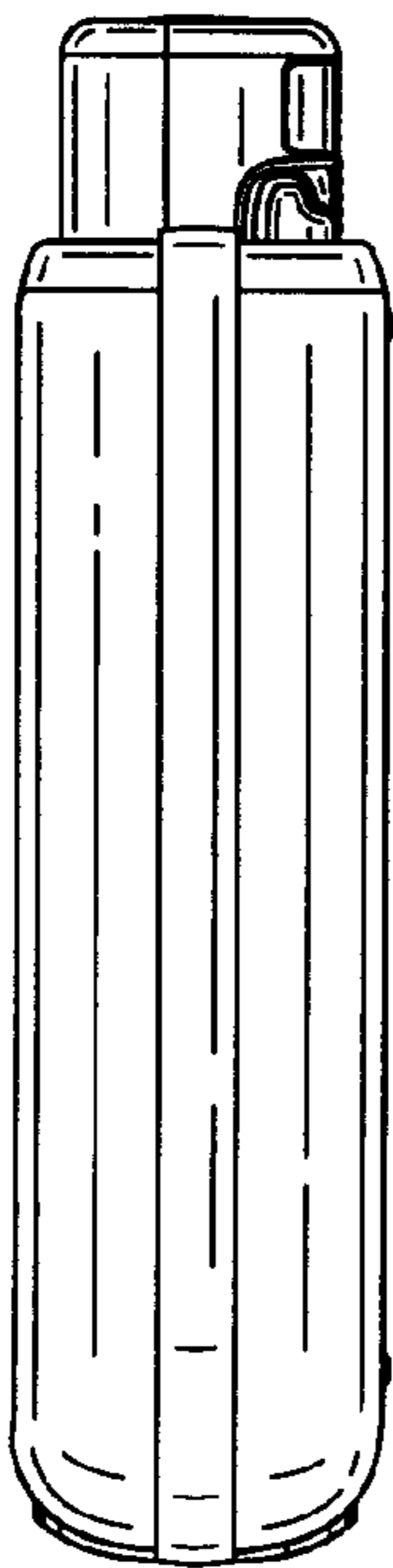

FIG. 7

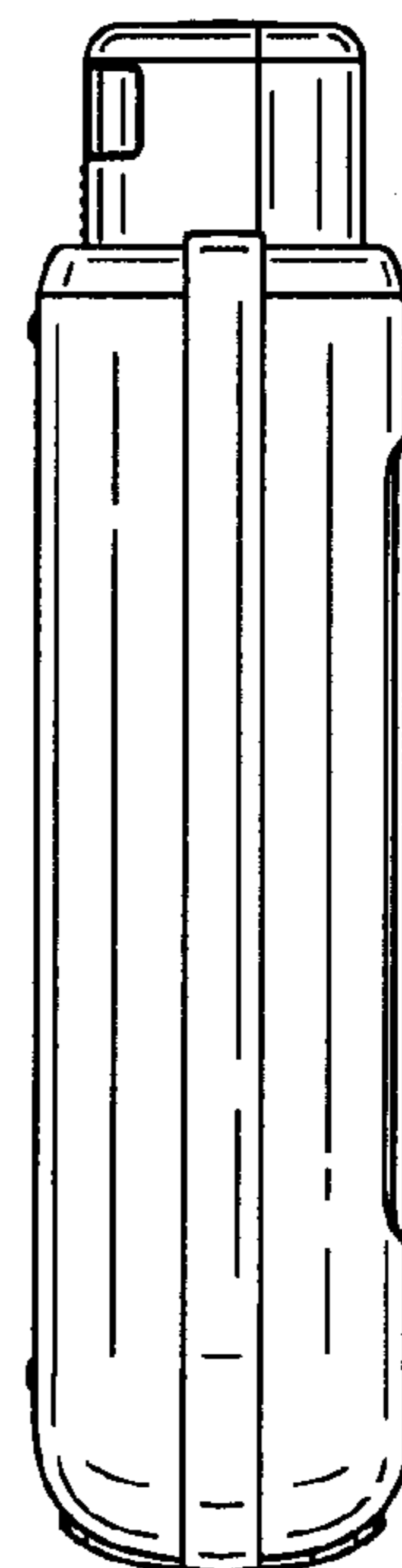

FIG. 8

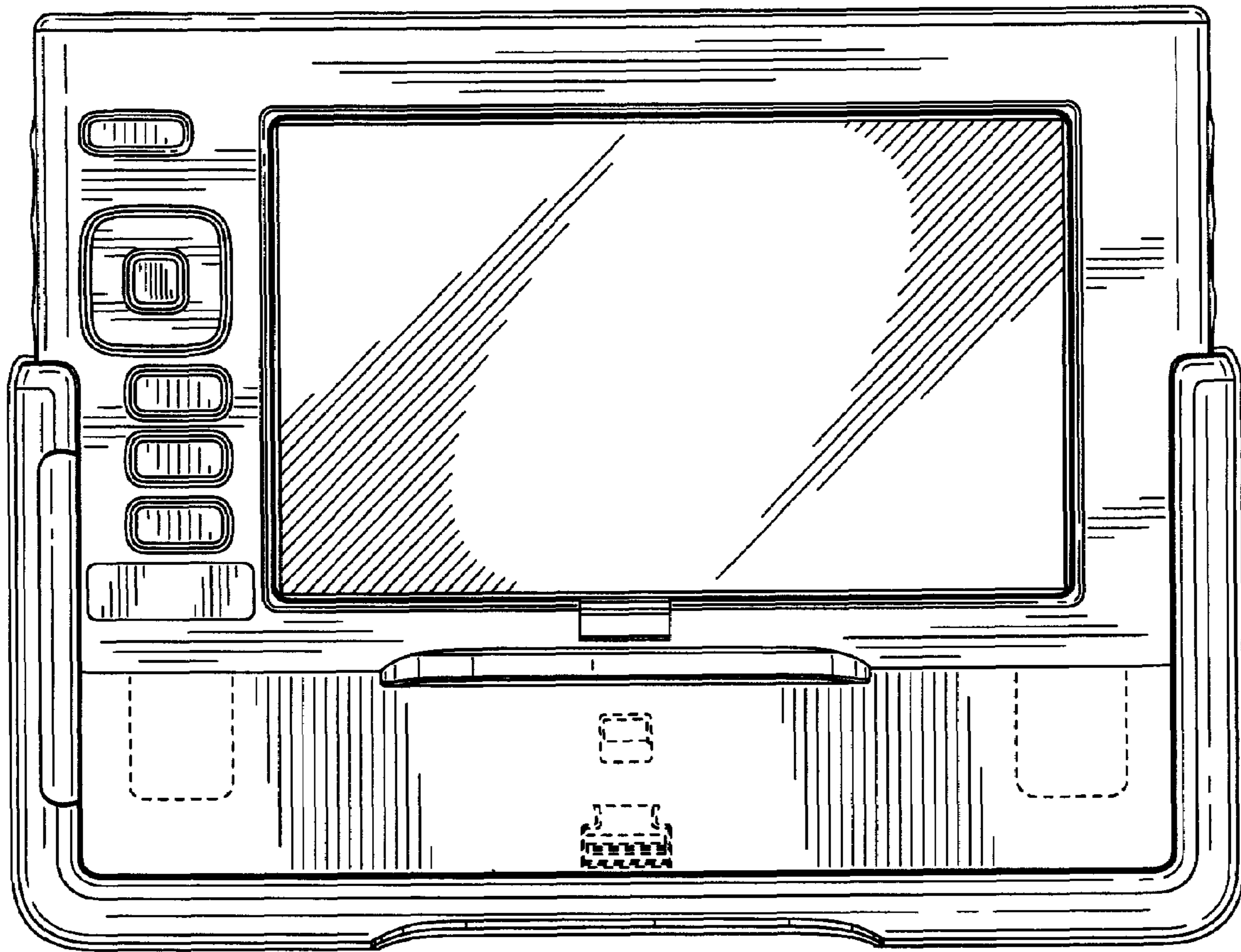

FIG. 9

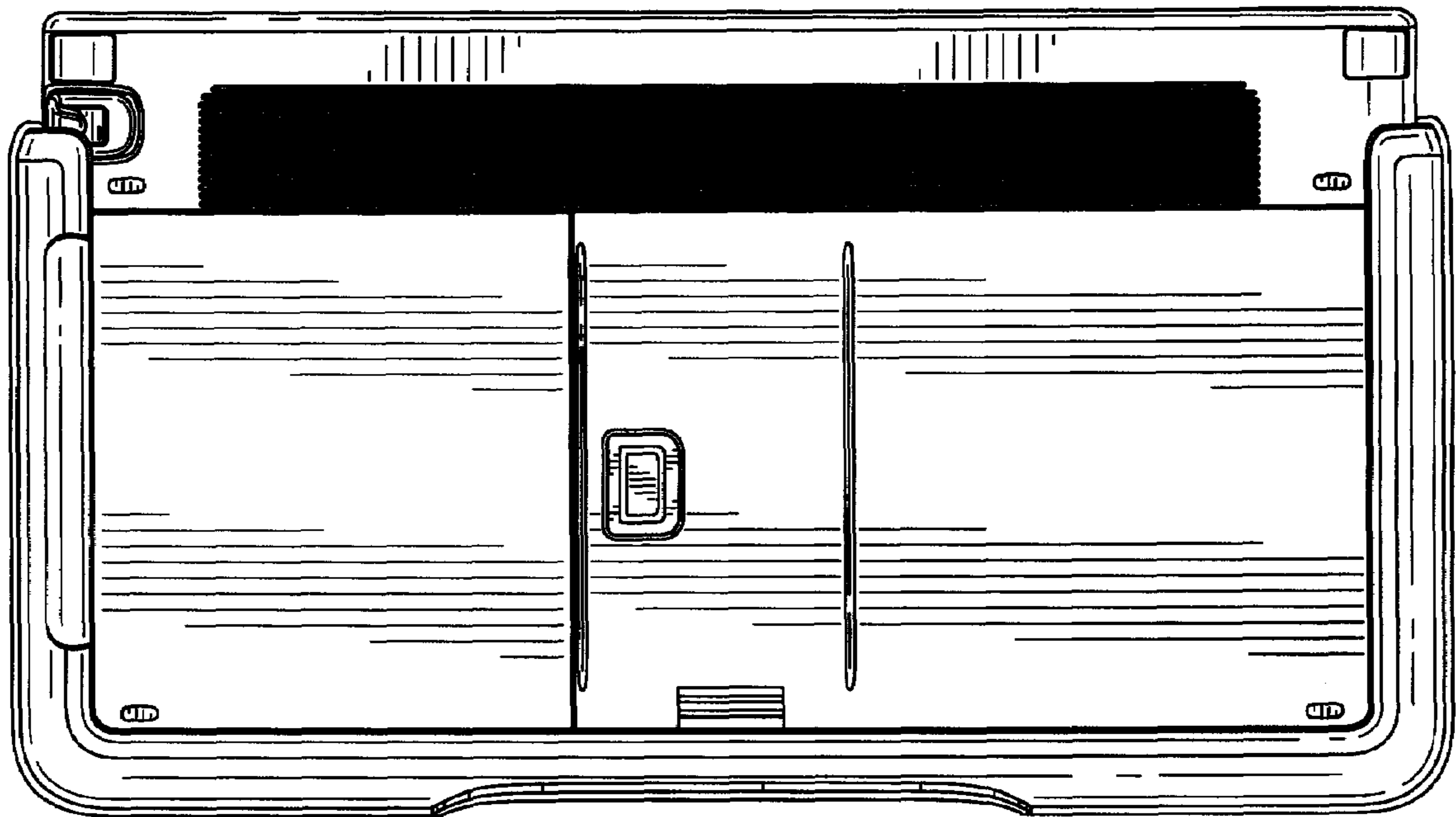

FIG. 10

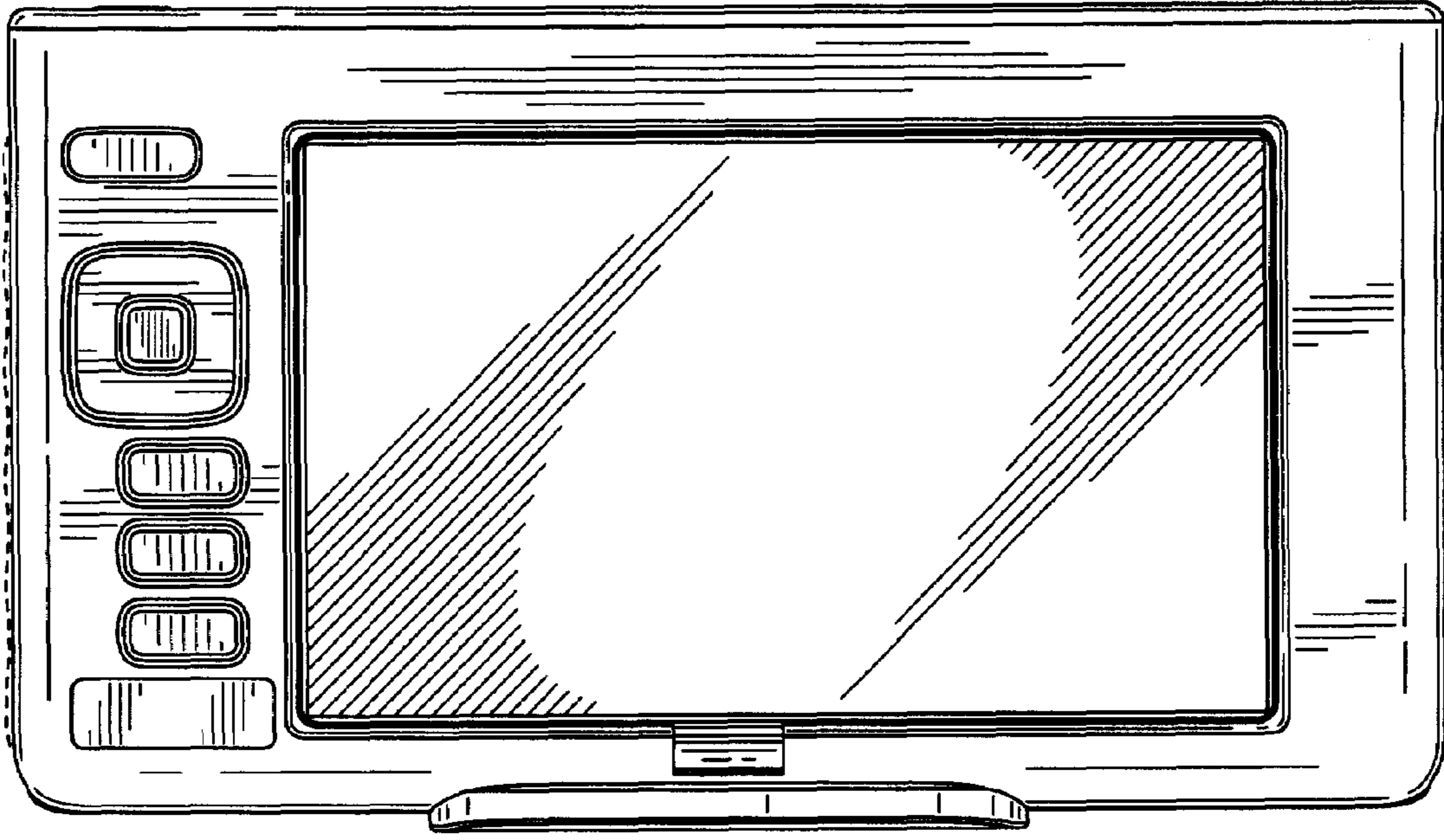

FIG. 11

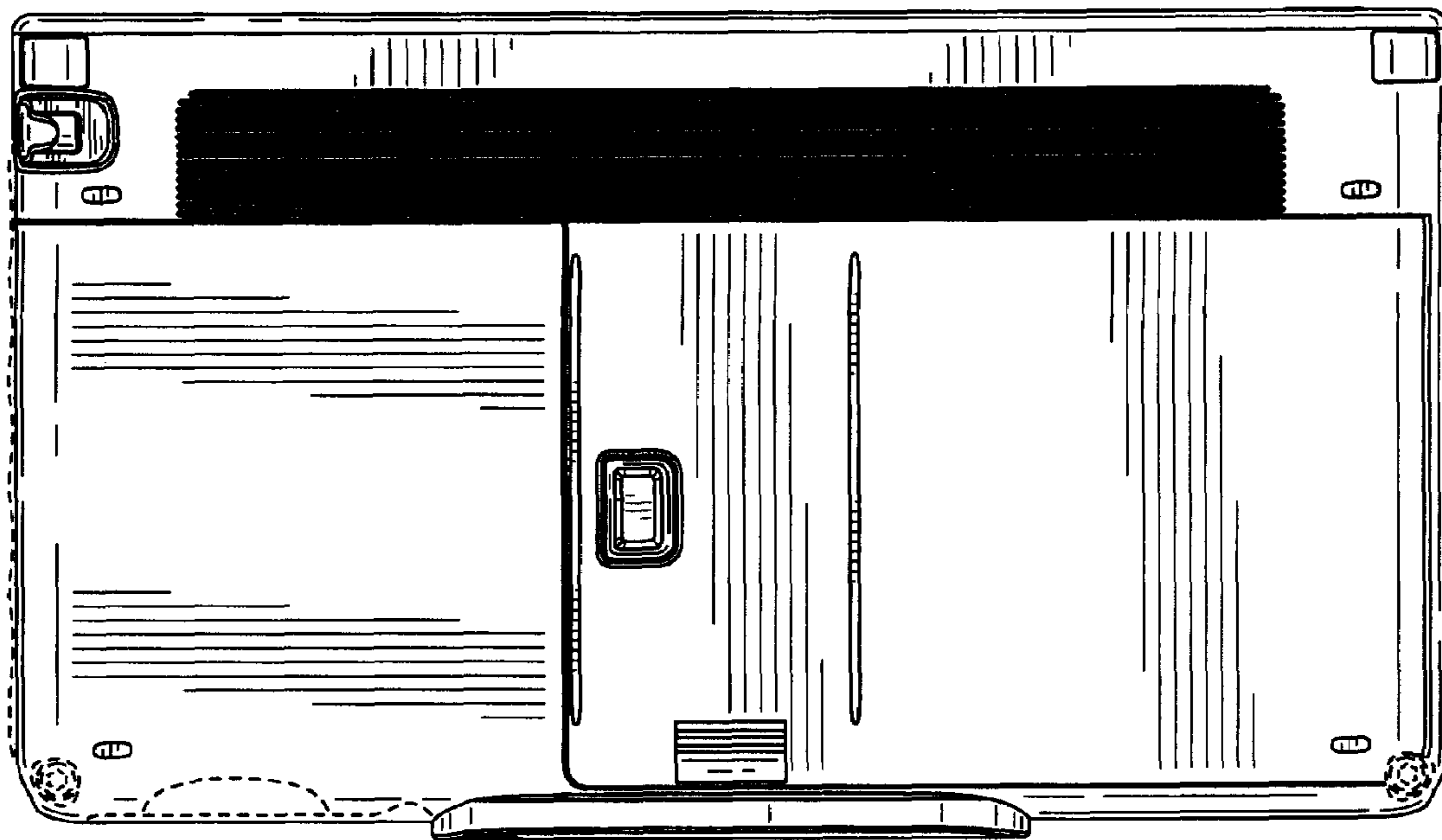

FIG. 12

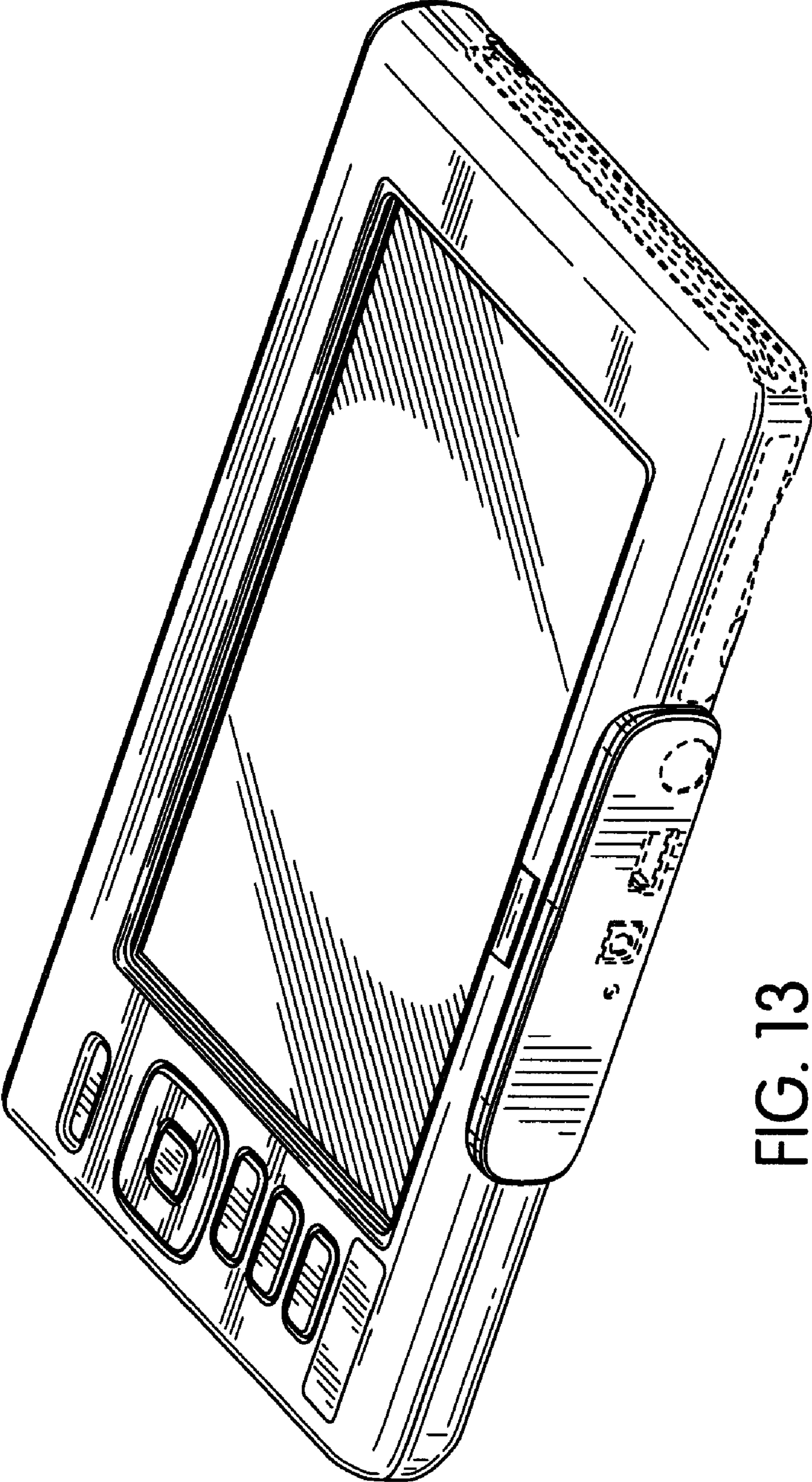

FIG. 13

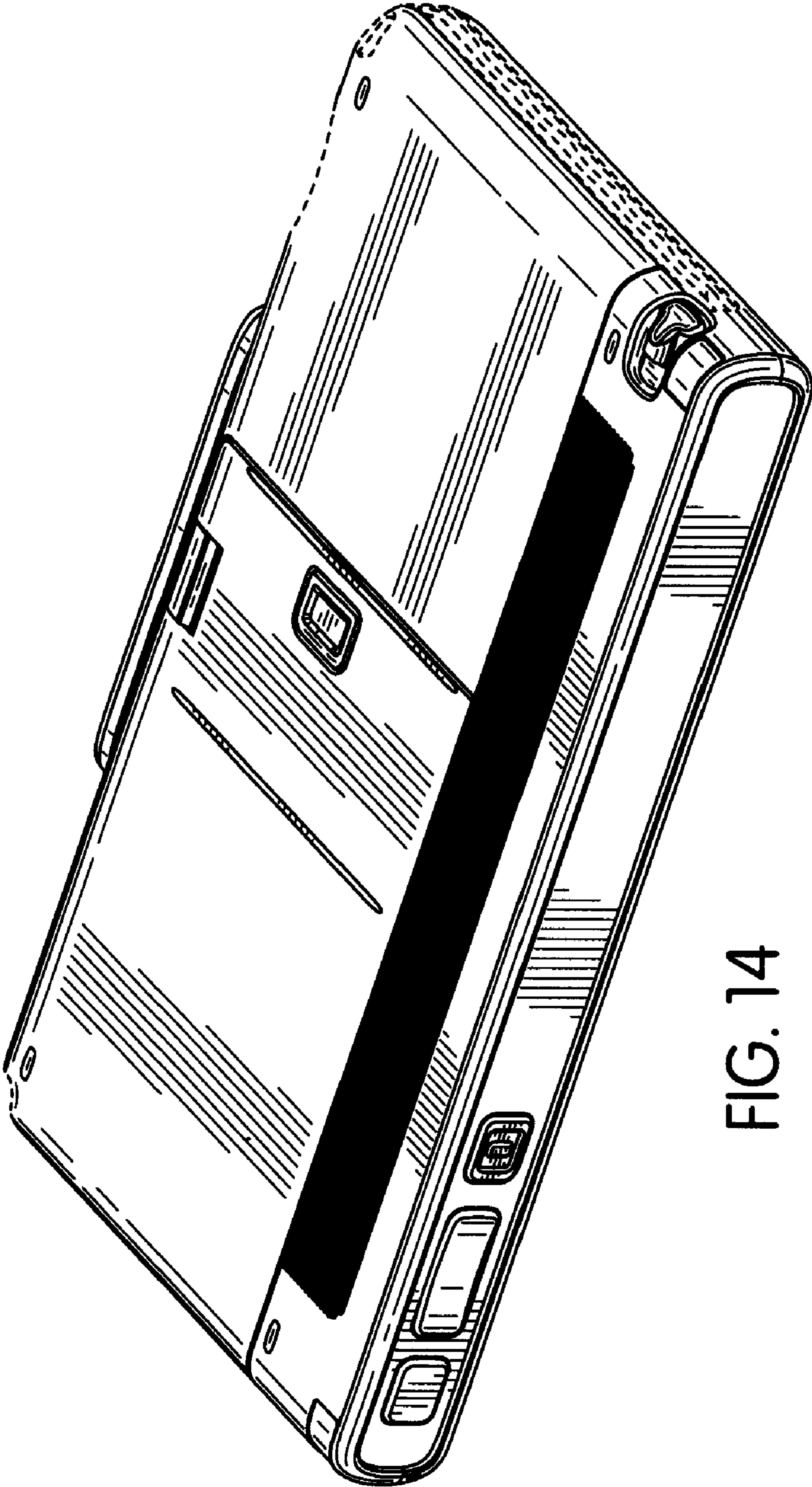

FIG. 14



FIG. 15



FIG. 16

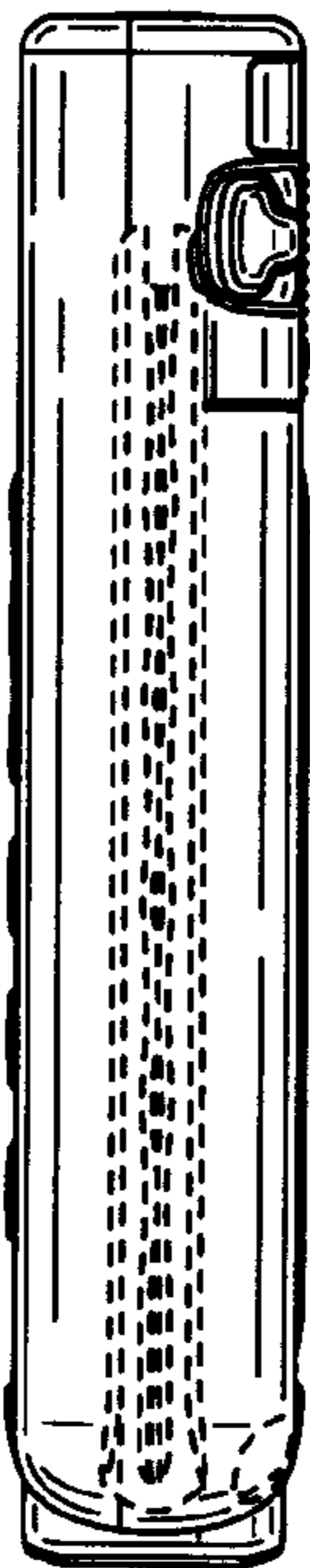

FIG. 17

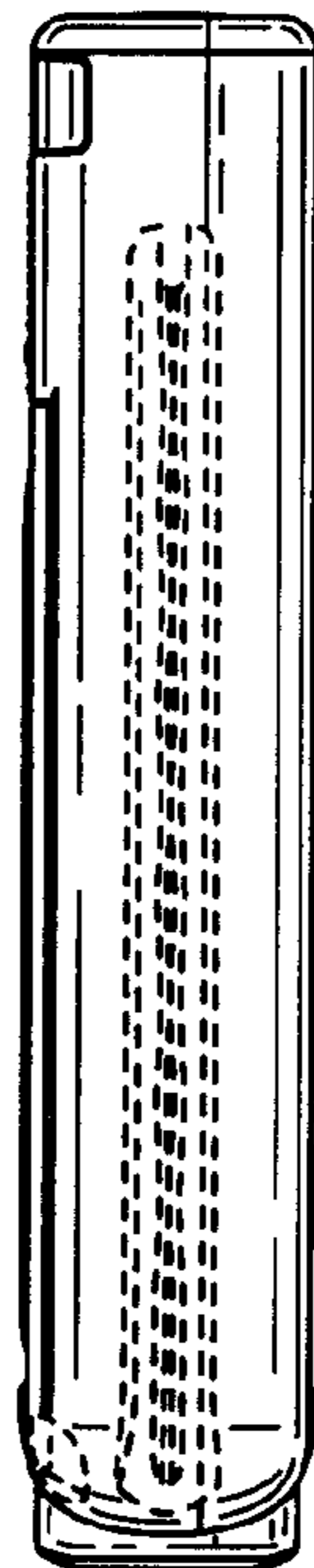

FIG. 18