

US00D548575S

(12) **United States Design Patent**
Kubota

(10) **Patent No.:** **US D548,575 S**

(45) **Date of Patent:** **** Aug. 14, 2007**

(54) **BACK PLATE FOR A HOOK TO HANG ON A WALL**

5,944,294 A * 8/1999 Baer 248/220.43

(75) Inventor: **Harunobu Kubota**, Tokyo (JP)

* cited by examiner

(73) Assignee: **Sugatsune Kogyo Co., Ltd.**,
Chiyoda-Ku (JP)

Primary Examiner—Holly H. Baynham

(74) *Attorney, Agent, or Firm*—Bacon & Thomas PLLC

(**) Term: **14 Years**

(57) **CLAIM**

(21) Appl. No.: **29/236,360**

The ornamental design for back plate for a hook to hang on a wall, as shown and described.

(22) Filed: **Aug. 16, 2005**

DESCRIPTION

(30) **Foreign Application Priority Data**

Feb. 23, 2005 (JP) 2005-004892

FIG. 1 is a front view of back plate for a hook to hang on a wall embodying my new design;

(51) **LOC (8) Cl.** **08-05**

FIG. 2 is a left side view thereof;

(52) **U.S. Cl.** **D8/373**

FIG. 3 is a rear view thereof;

(58) **Field of Classification Search** D8/373,

FIG. 4 is a plan view thereof;

D8/367, 372, 566, 553; 248/301, 304, 214-215,
248/220.41, 220.42, 220.43

FIG. 5 is a bottom view thereof;

See application file for complete search history.

FIG. 6 is an environmental, perspective view thereof; and,

FIG. 7 is a reduced scale environmental, perspective view.

(56) **References Cited**

The broken line showing of partial structure and a hook is included for the purpose of illustrating environment and forms no part of the claimed design.

U.S. PATENT DOCUMENTS

2,991,968 A * 7/1961 Lydard 248/220.42
D340,110 S * 10/1993 Reed et al. D23/389

1 Claim, 4 Drawing Sheets

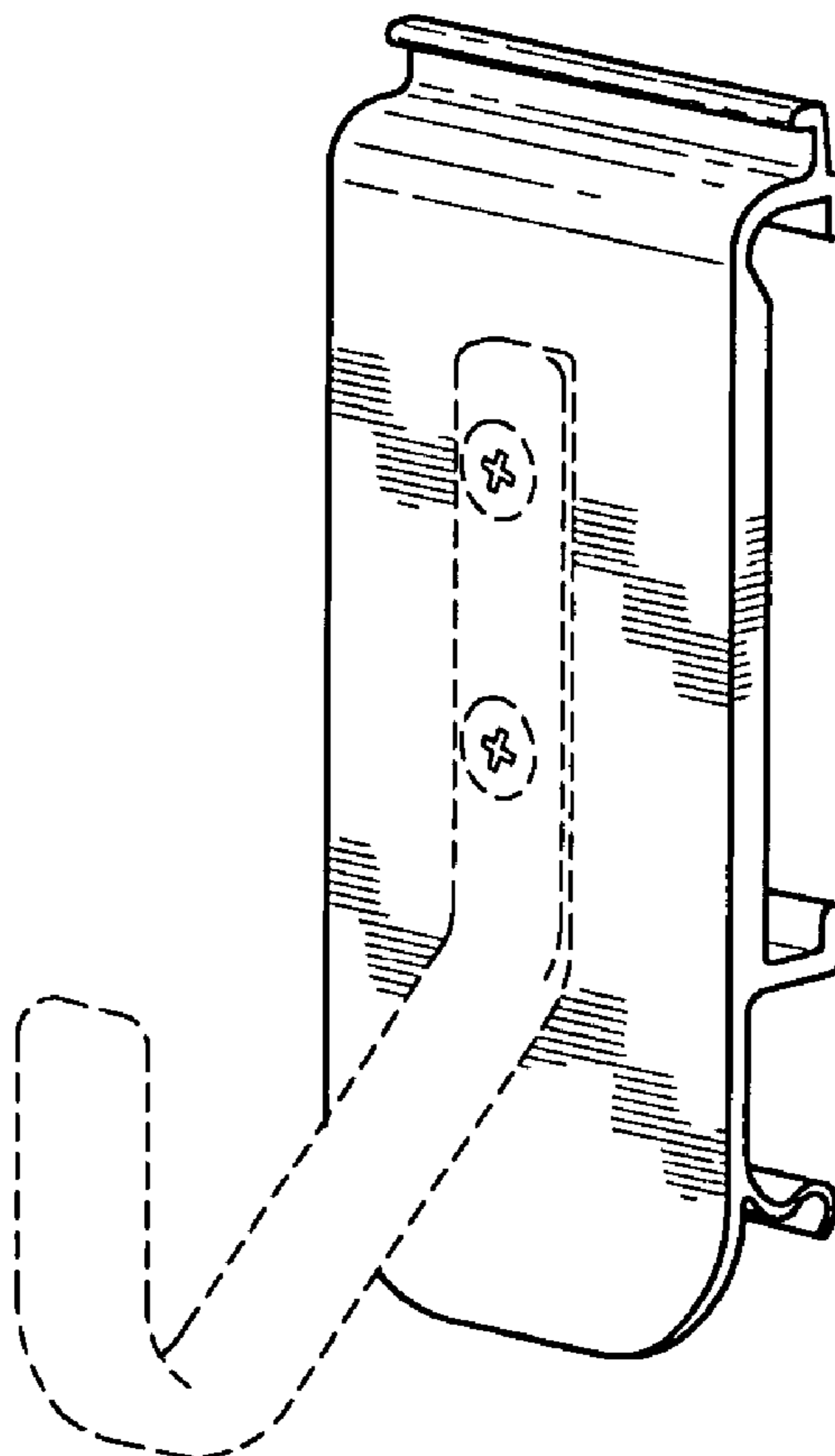

FIG. 1

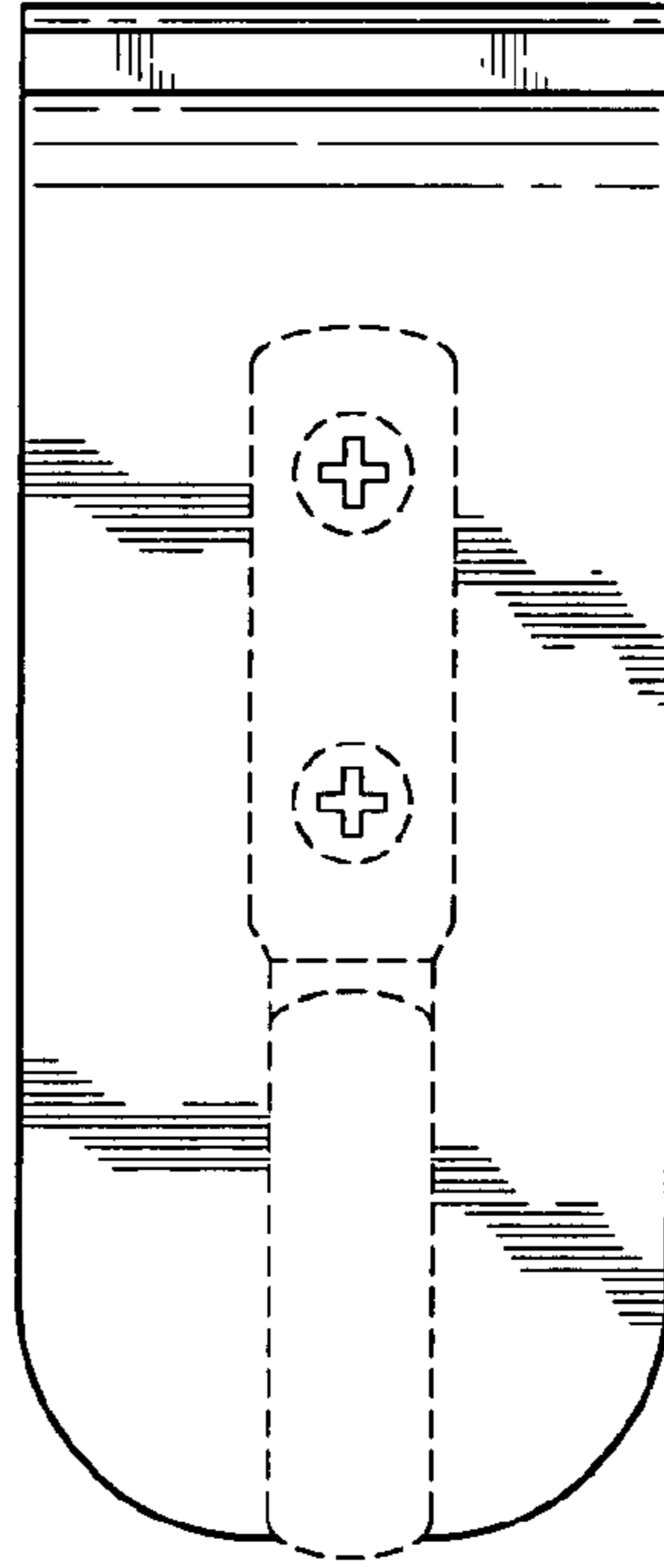

FIG. 2

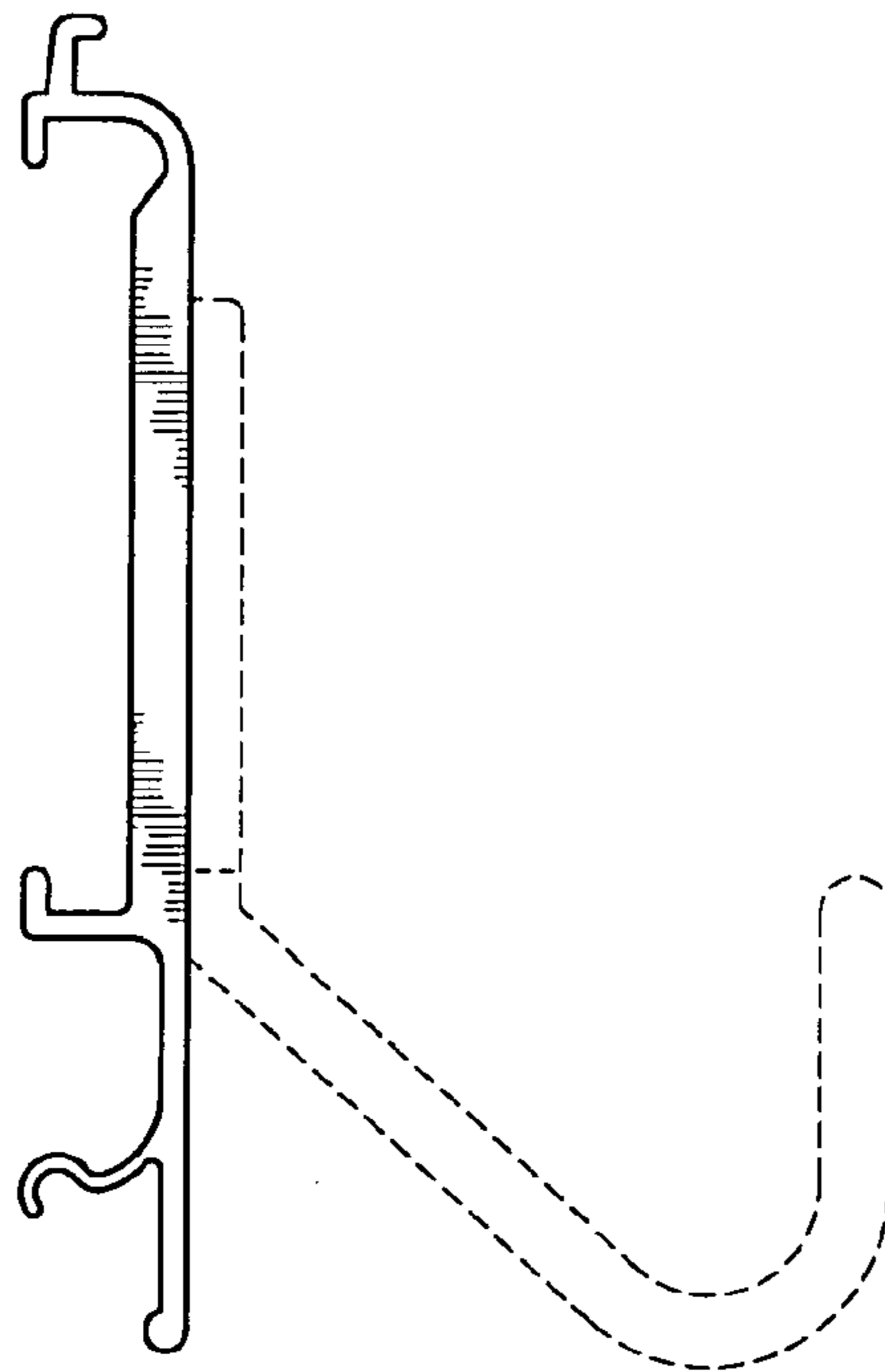

FIG. 3

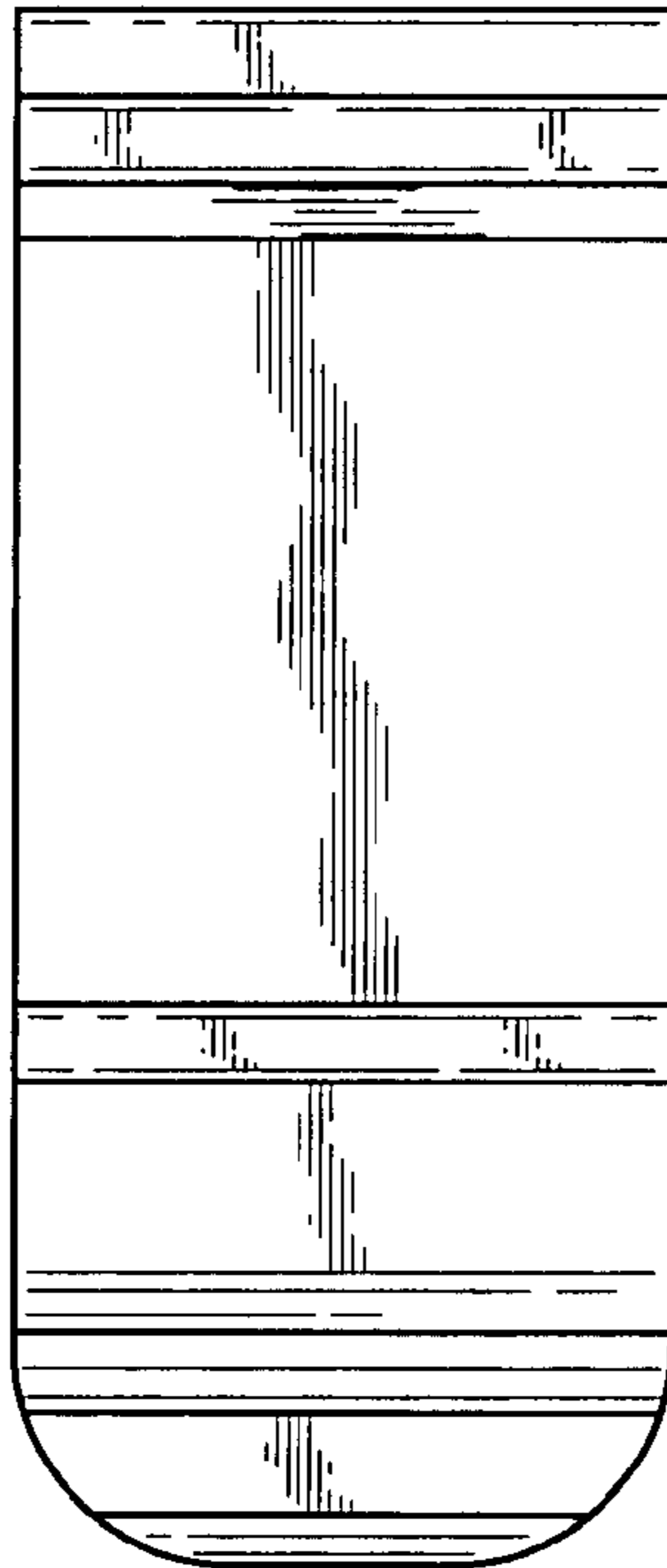

FIG. 4

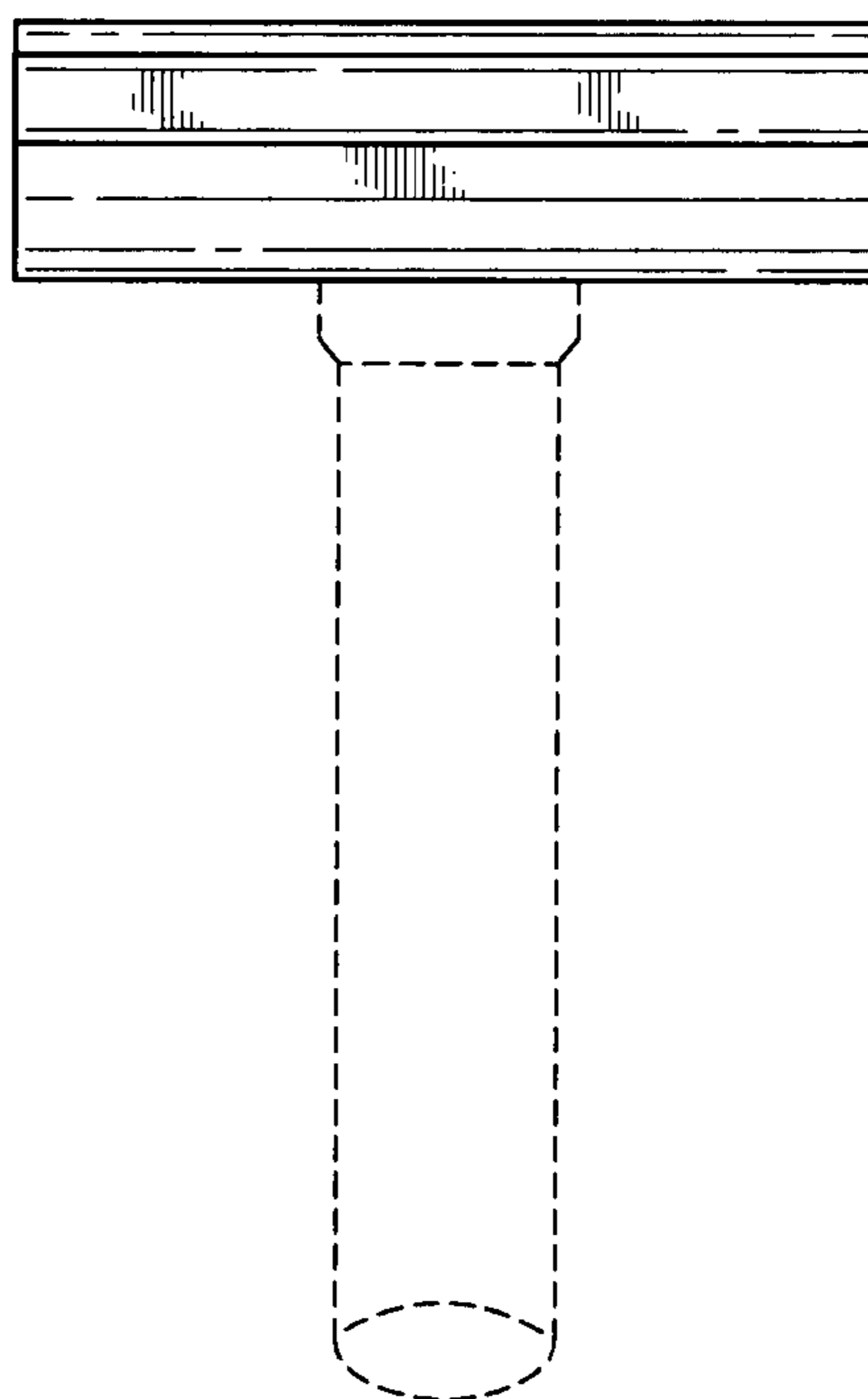

FIG. 5

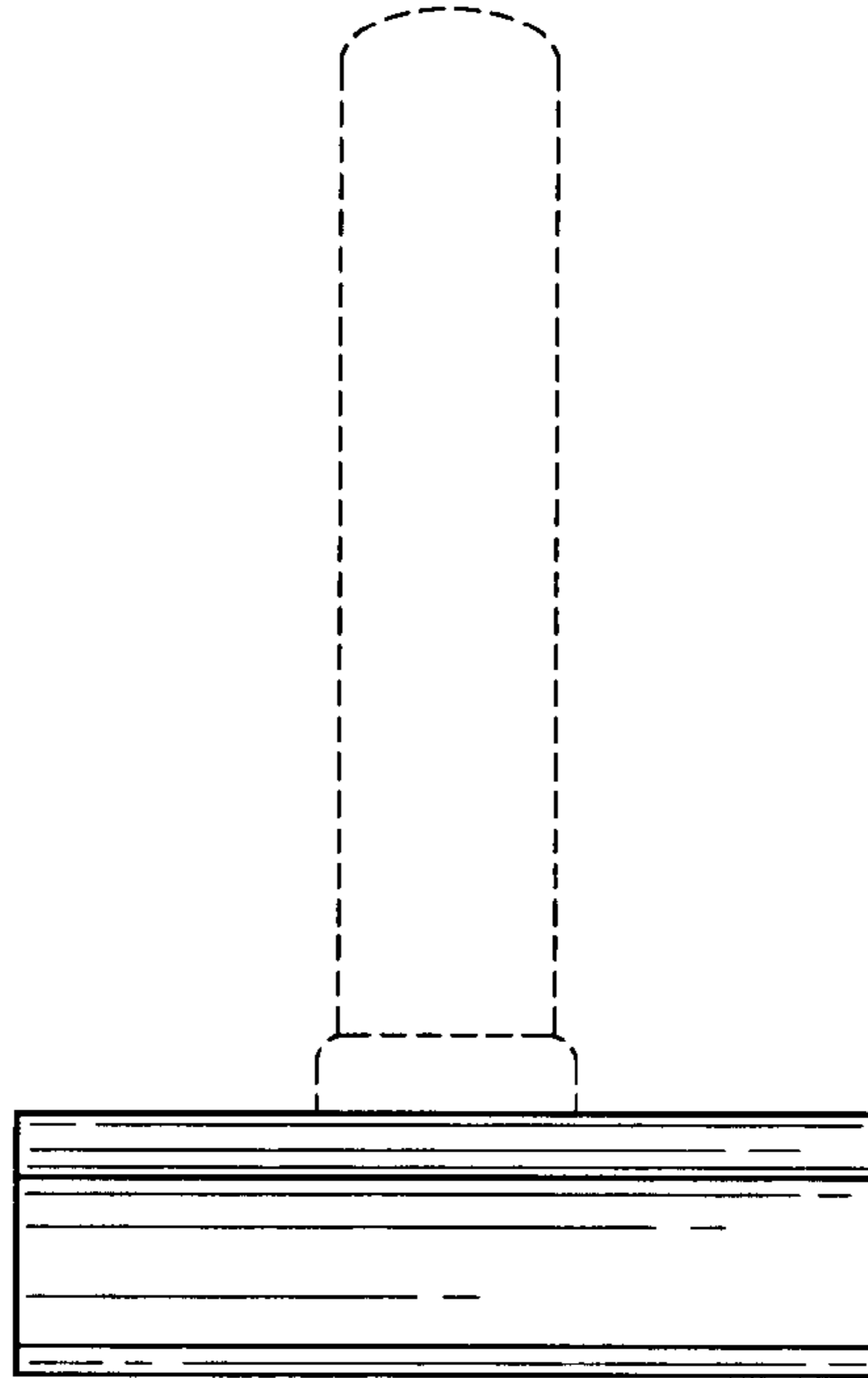

FIG. 6

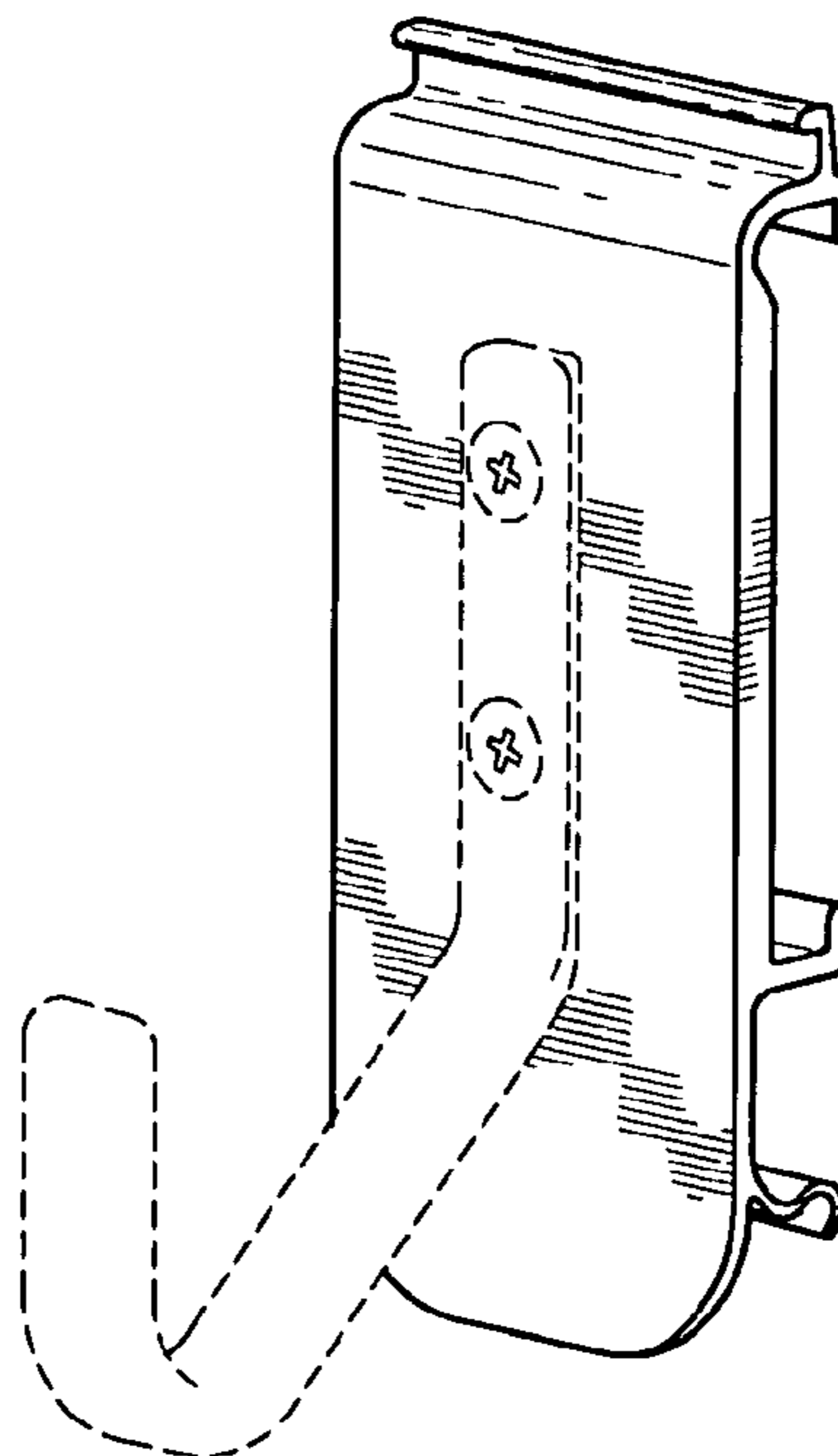

FIG. 7

