



US00D548566S

(12) **United States Design Patent** (10) **Patent No.:** **US D548,566 S**
Smaldone (45) **Date of Patent:** **** Aug. 14, 2007**

(54) **LOCK**

(75) Inventor: **Alfonso Smaldone**, Brooklyn, NY (US)

(73) Assignee: **Safe Skies LLC**, New York, NY (US)

(**) Term: **14 Years**

(21) Appl. No.: **29/252,786**

(22) Filed: **Jan. 27, 2006**

(51) **LOC (8) Cl.** **08-07**

(52) **U.S. Cl.** **D8/334**

(58) **Field of Classification Search** D8/330-348;
70/20-29, 53, 58, 233, 38 R, 38 A, 38 B,
70/DIG. 9, DIG. 63, DIG. 70

See application file for complete search history.

(56) **References Cited**

U.S. PATENT DOCUMENTS

D316,955 S * 5/1991 Goida et al. D8/334
D372,187 S * 7/1996 Ling D8/334

(Continued)

OTHER PUBLICATIONS

www.tamperseal.com, Search Alert TSA Luggage Locks;
Searchalert Case TSA Lock, Apr. 27, 2006; Relevant pp. 2 of 2.

Primary Examiner—Mitchell Siegel

(74) *Attorney, Agent, or Firm*—Steven Horowitz

(57) **CLAIM**

The ornamental design for a lock, as shown and described.

DESCRIPTION

FIG. 1 is a front elevational view of the lock of the present invention showing my new design;

FIG. 2 is a rear elevational view thereof;

FIG. 3 is a right side view thereof;

FIG. 4 is a left side view thereof;

FIG. 5 is a bottom view thereof;

FIG. 6 is a top view thereof;

FIG. 7 is a perspective view thereof;

FIG. 8 is a front elevational view of a second embodiment of the lock of the present invention having three dials;

FIG. 9 is a rear elevational view of the second embodiment shown in FIG. 8;

FIG. 10 is a right side view of the second embodiment shown in FIG. 8;

FIG. 11 is a left side view of the second embodiment shown in FIG. 8;

FIG. 12 is a bottom view of the second embodiment shown in FIG. 8;

FIG. 13 is a top view of the second embodiment shown in FIG. 8;

FIG. 14 is a perspective view of the second embodiment shown in FIG. 8;

FIG. 15 is a rear elevational view of a third embodiment of the present invention shown in FIG. 2 without the shackle blocker;

FIG. 16 is a perspective view of the third embodiment shown in FIG. 15;

FIG. 17 is a top view of the third embodiment shown in FIG. 15;

FIG. 18 is a rear elevational view of a fourth embodiment of the present invention shown in FIG. 9 without the shackle blocker

FIG. 19 is a perspective view of the fourth embodiment shown in FIG. 18; and,

FIG. 20 is a top view of the fourth embodiment shown in FIG. 18.

The broken line showing is included for the purpose of illustrating and forms no part of the claimed design.

1 Claim, 6 Drawing Sheets

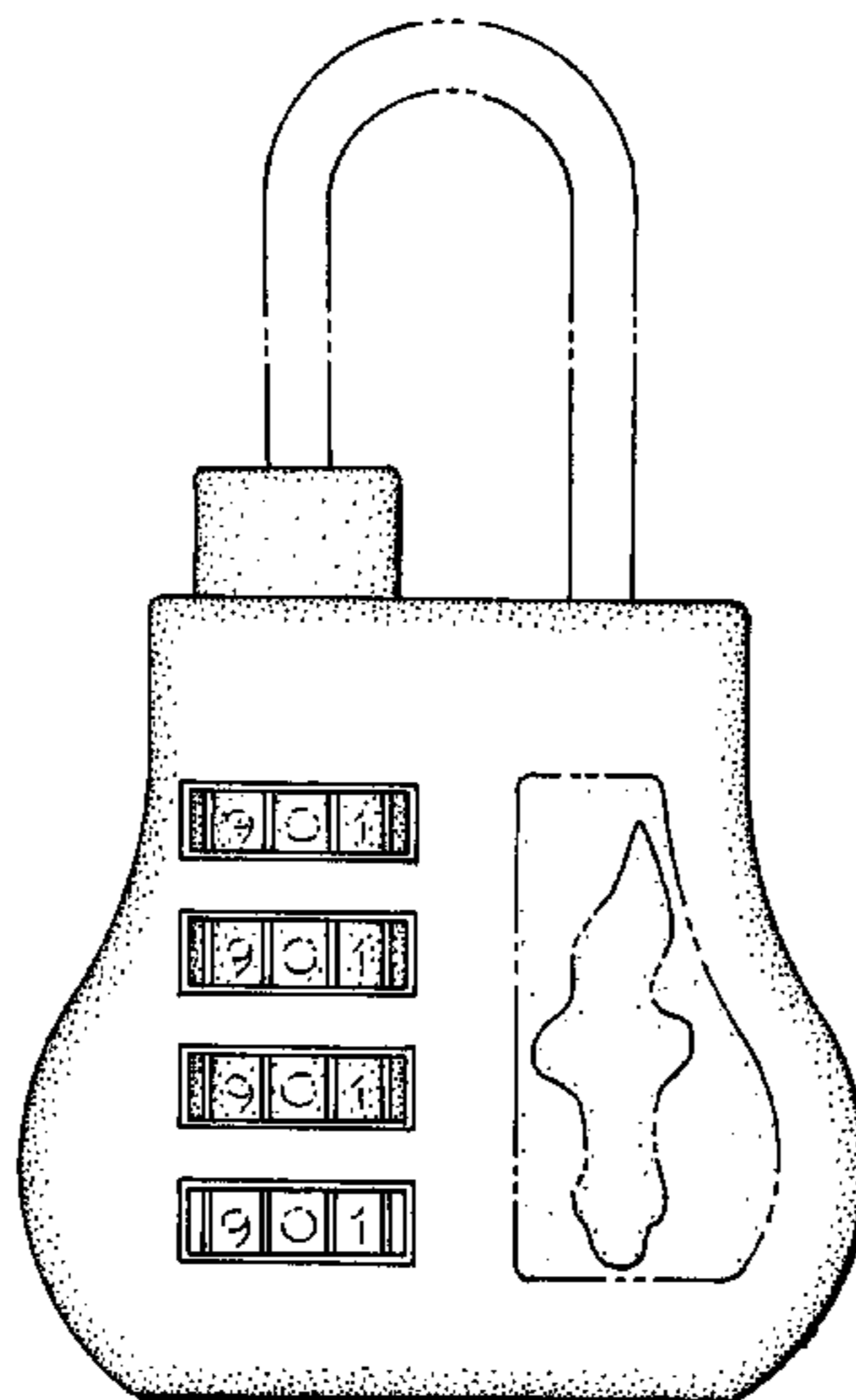

US D548,566 S

Page 2

U.S. PATENT DOCUMENTS

D434,635 S	*	12/2000	Ruan	D8/334	
D453,467 S	*	2/2002	Nakamura	D8/334	
D472,790 S	*	4/2003	Lai	D8/334	
D486,720 S	*	2/2004	Ling	D8/334	
D497,303 S	*	10/2004	Sun	D8/334	
D535,548 S	*	1/2007	Lin	D8/334	

* cited by examiner

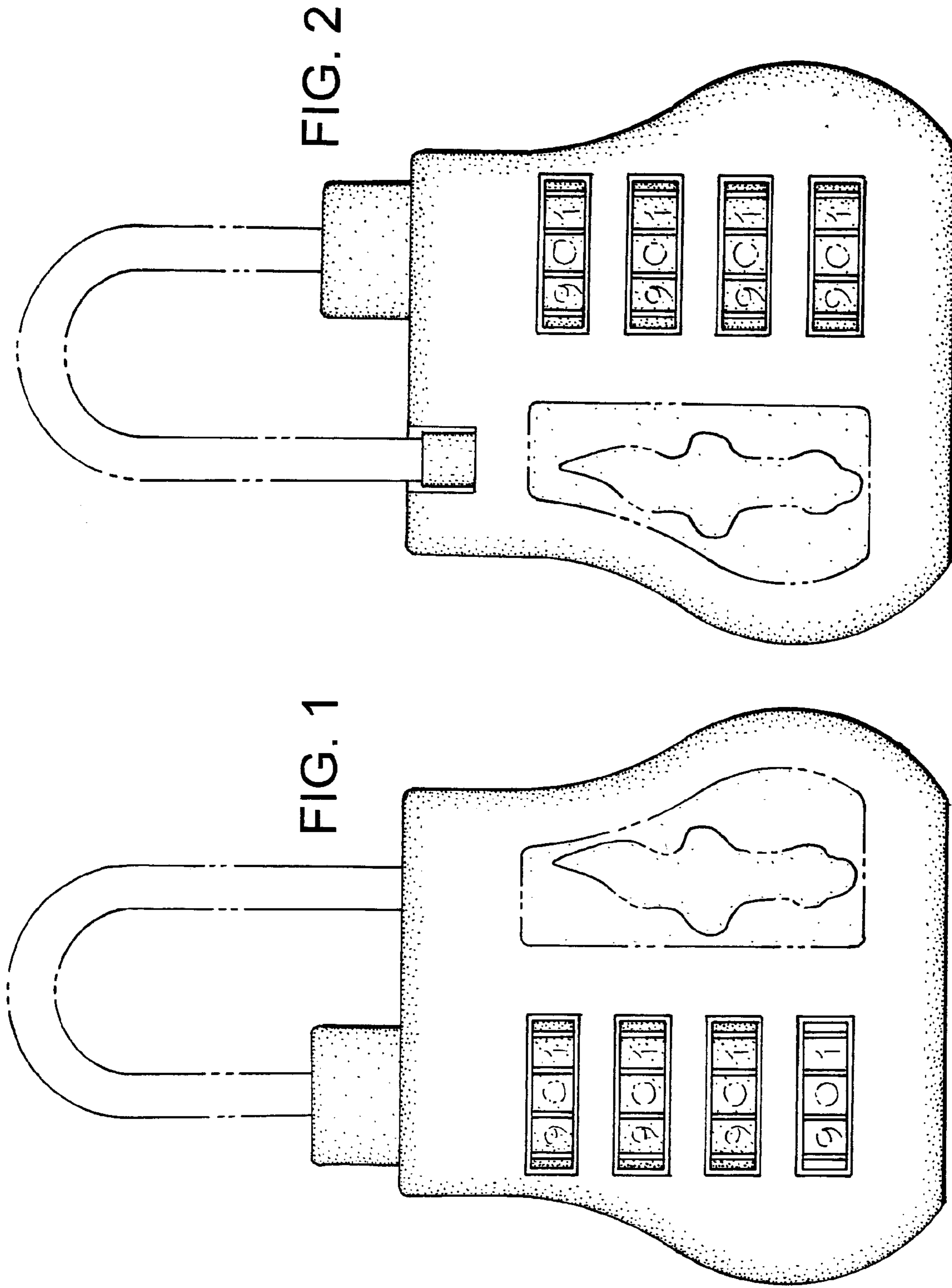

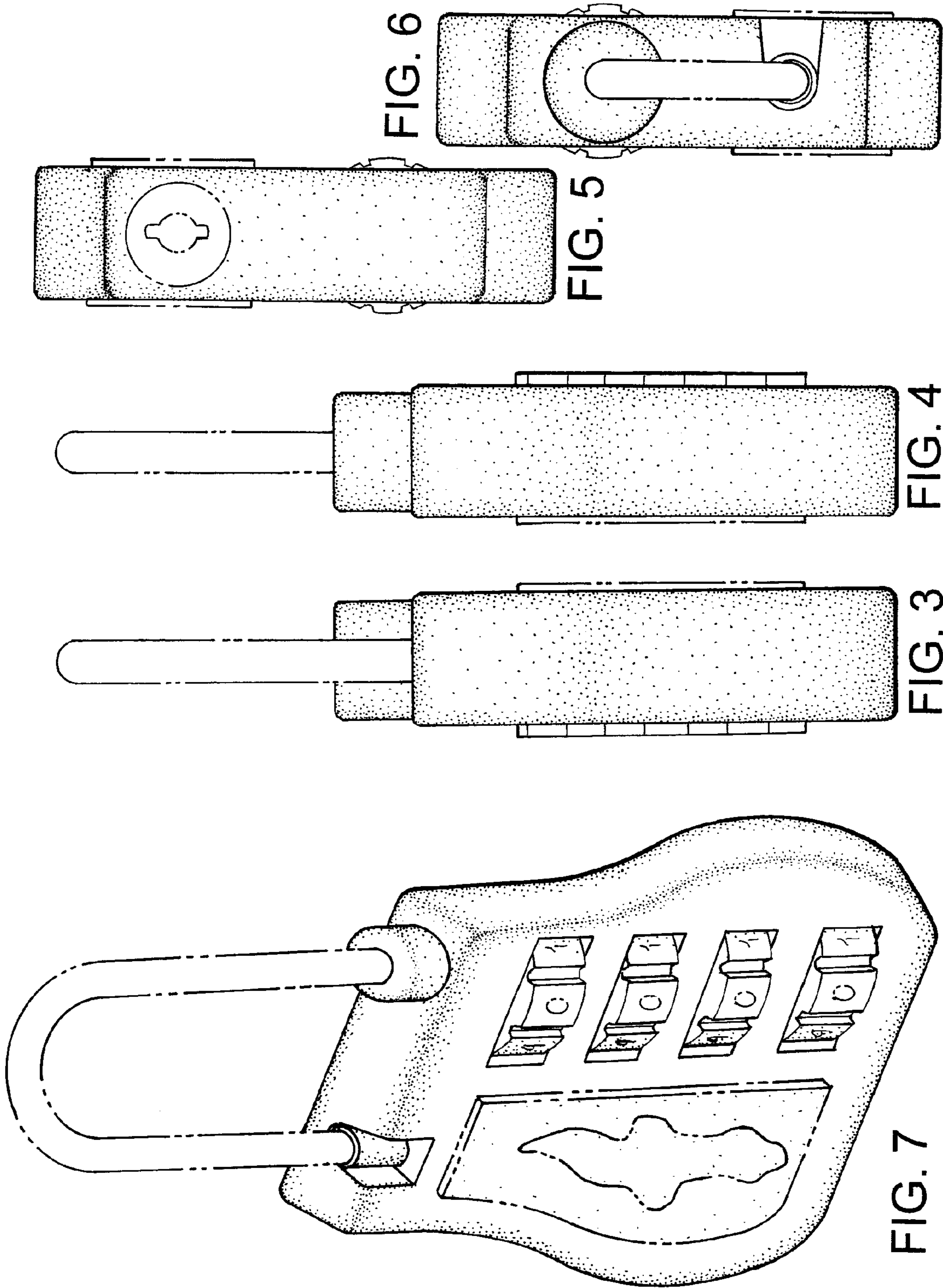

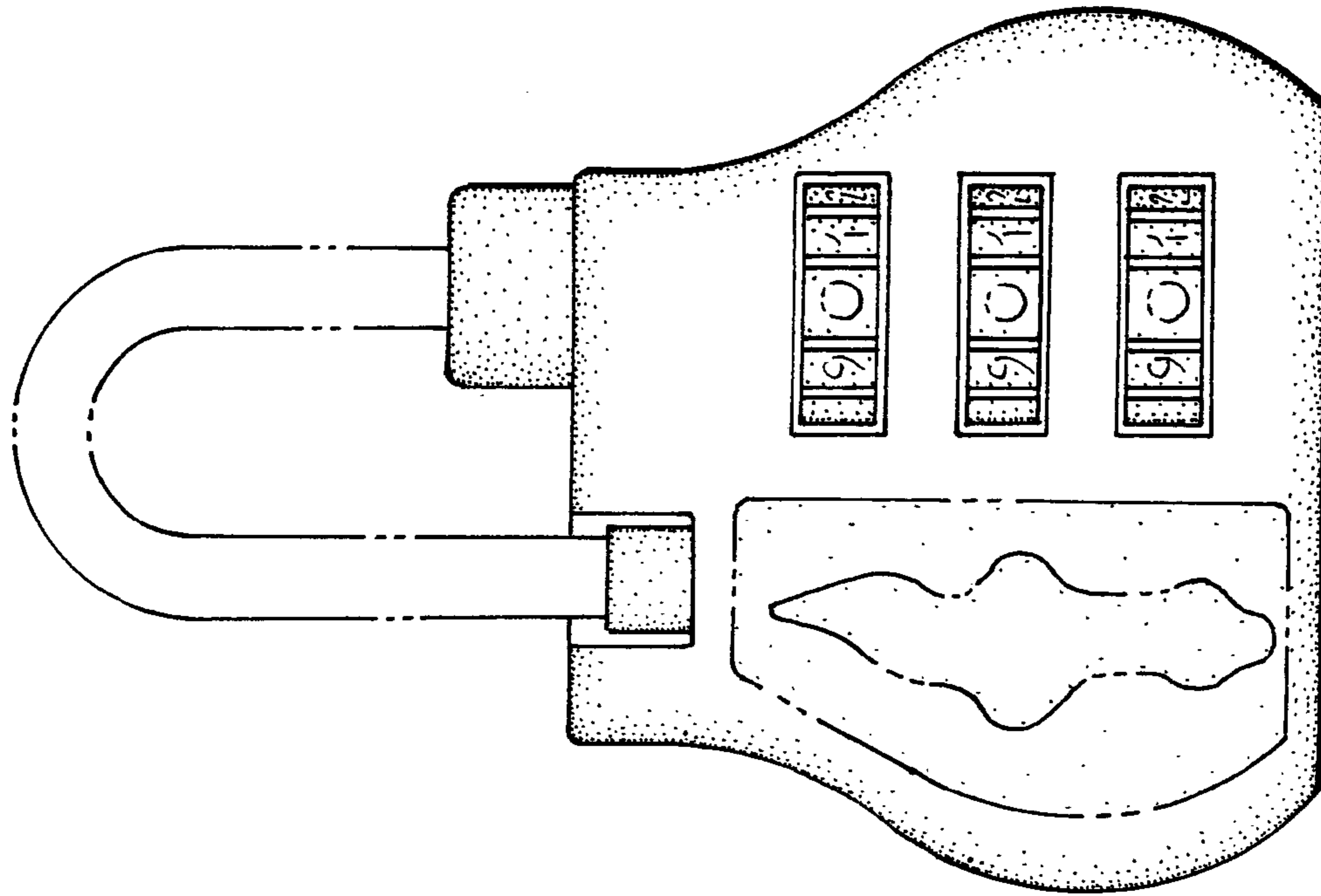

FIG. 9

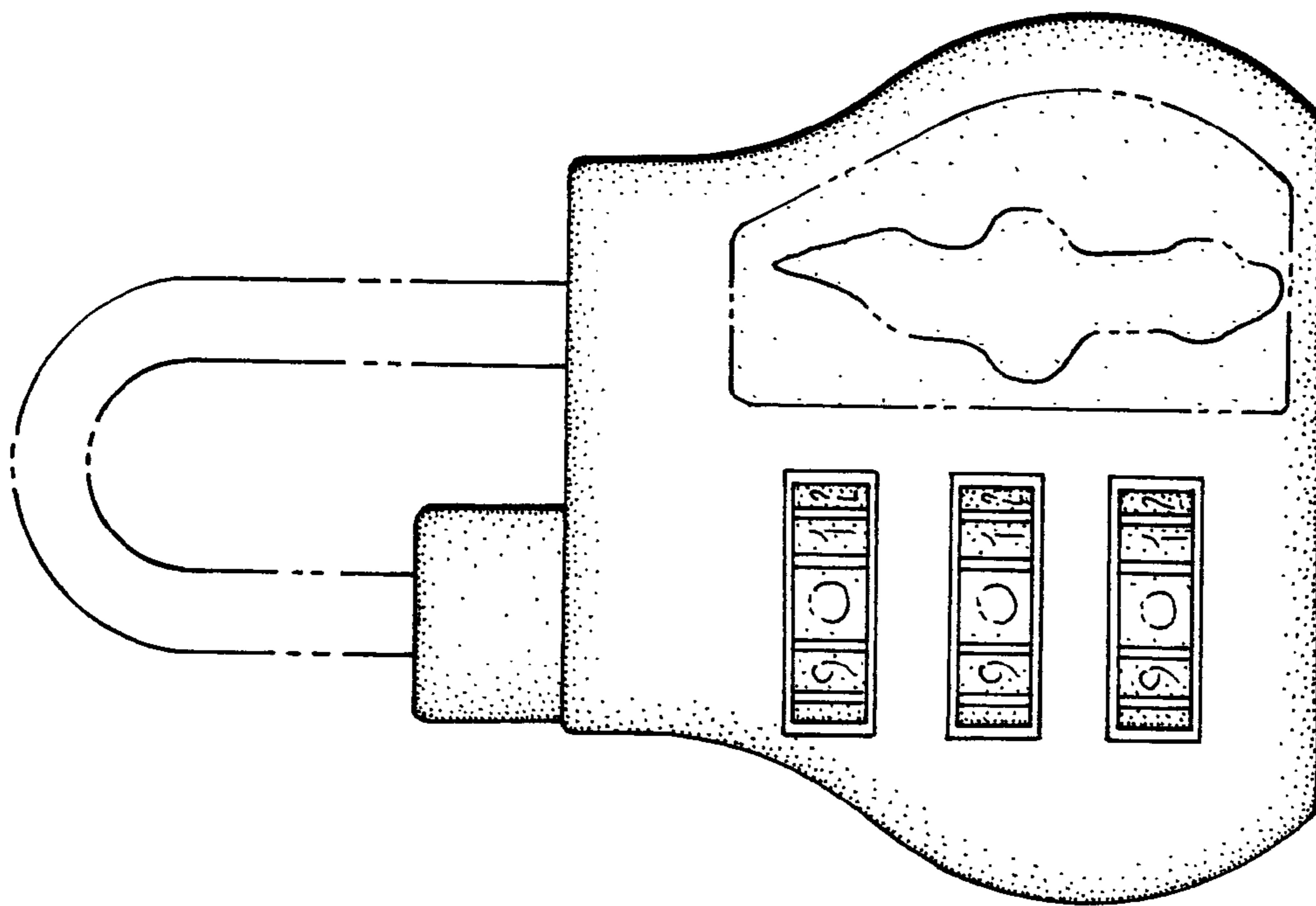

FIG. 8

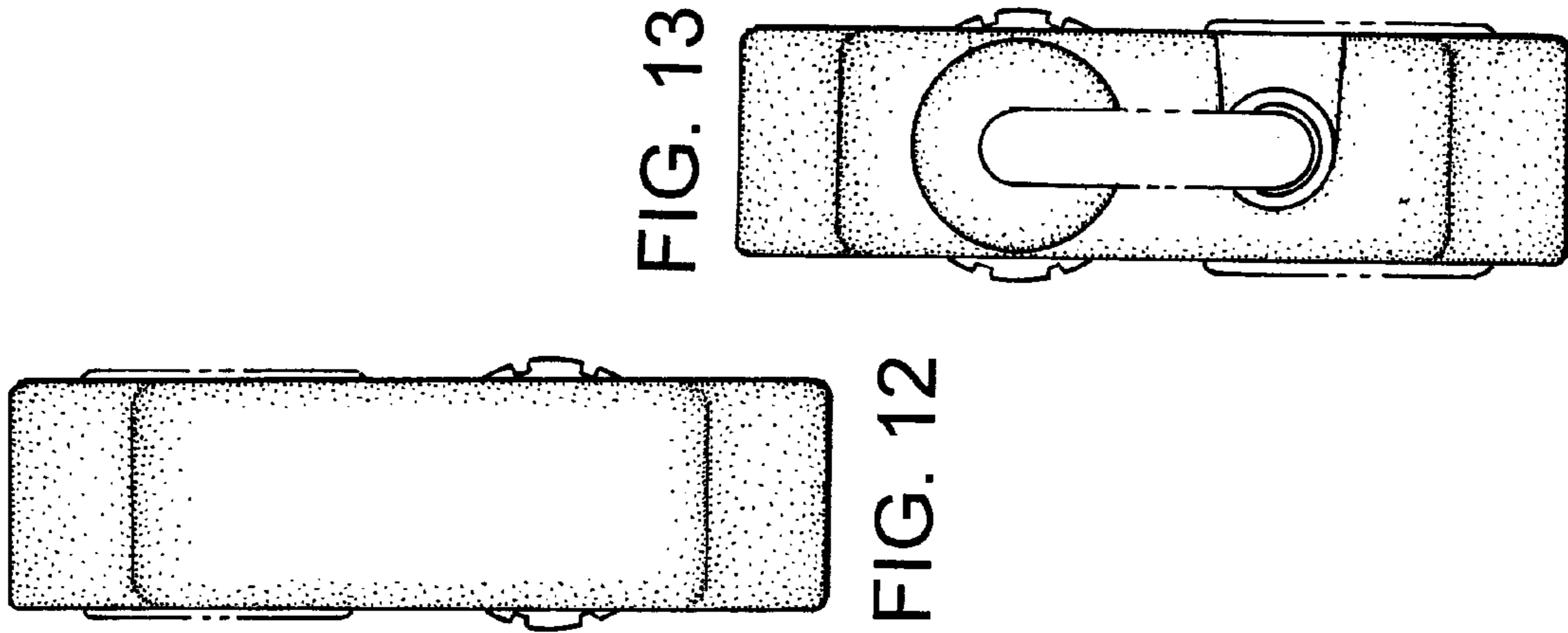

FIG. 10

FIG. 11

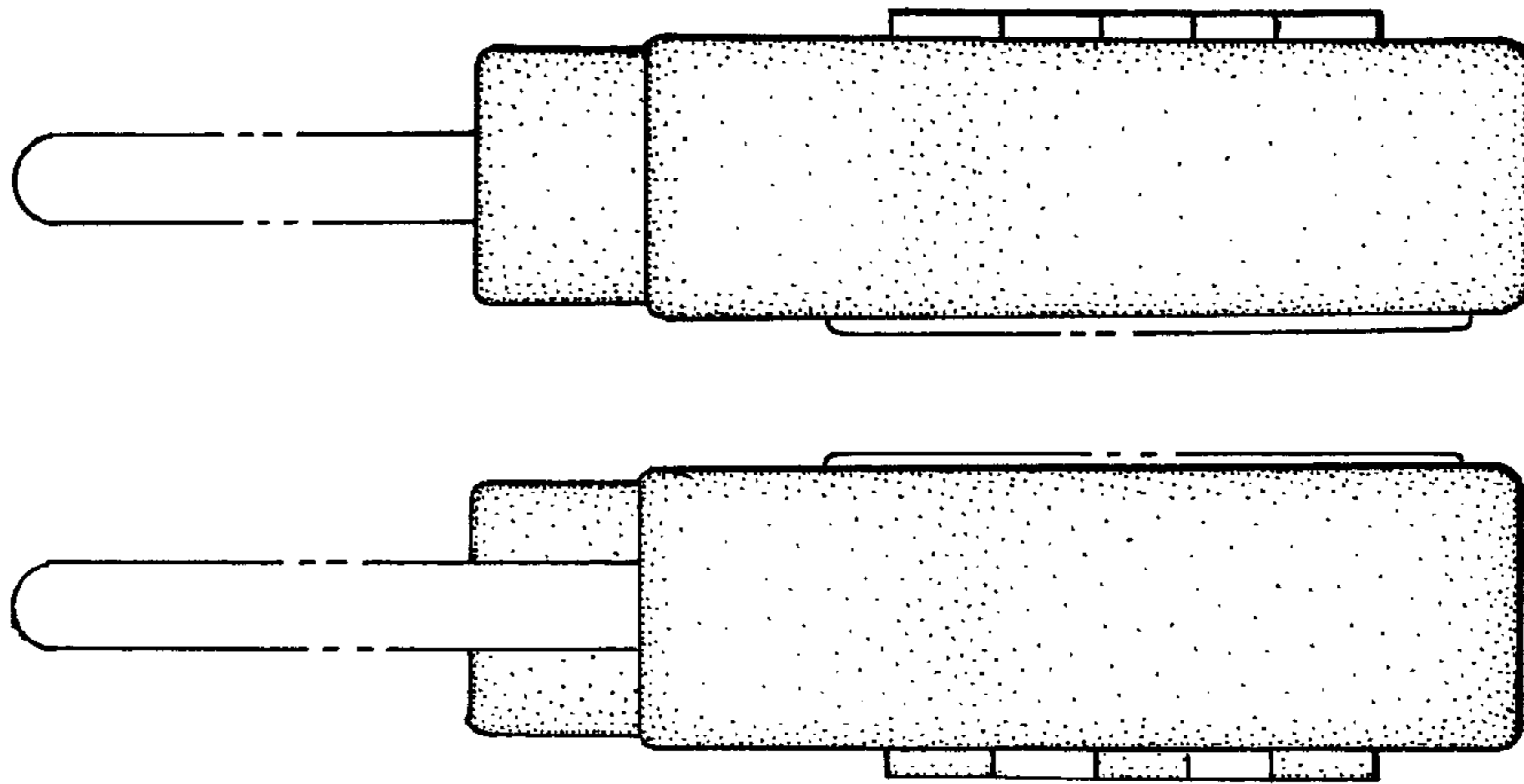

FIG. 13

FIG. 12

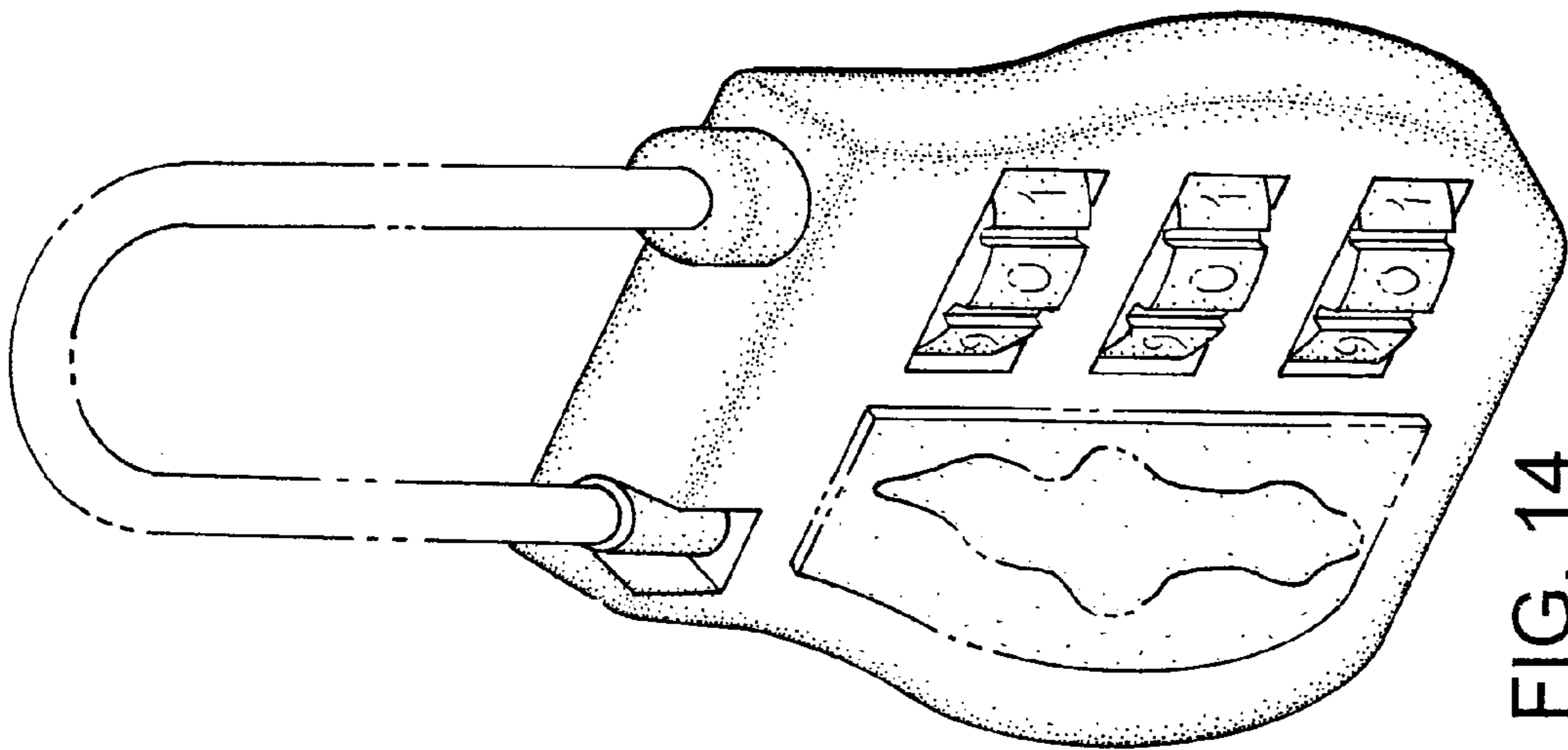

FIG. 14

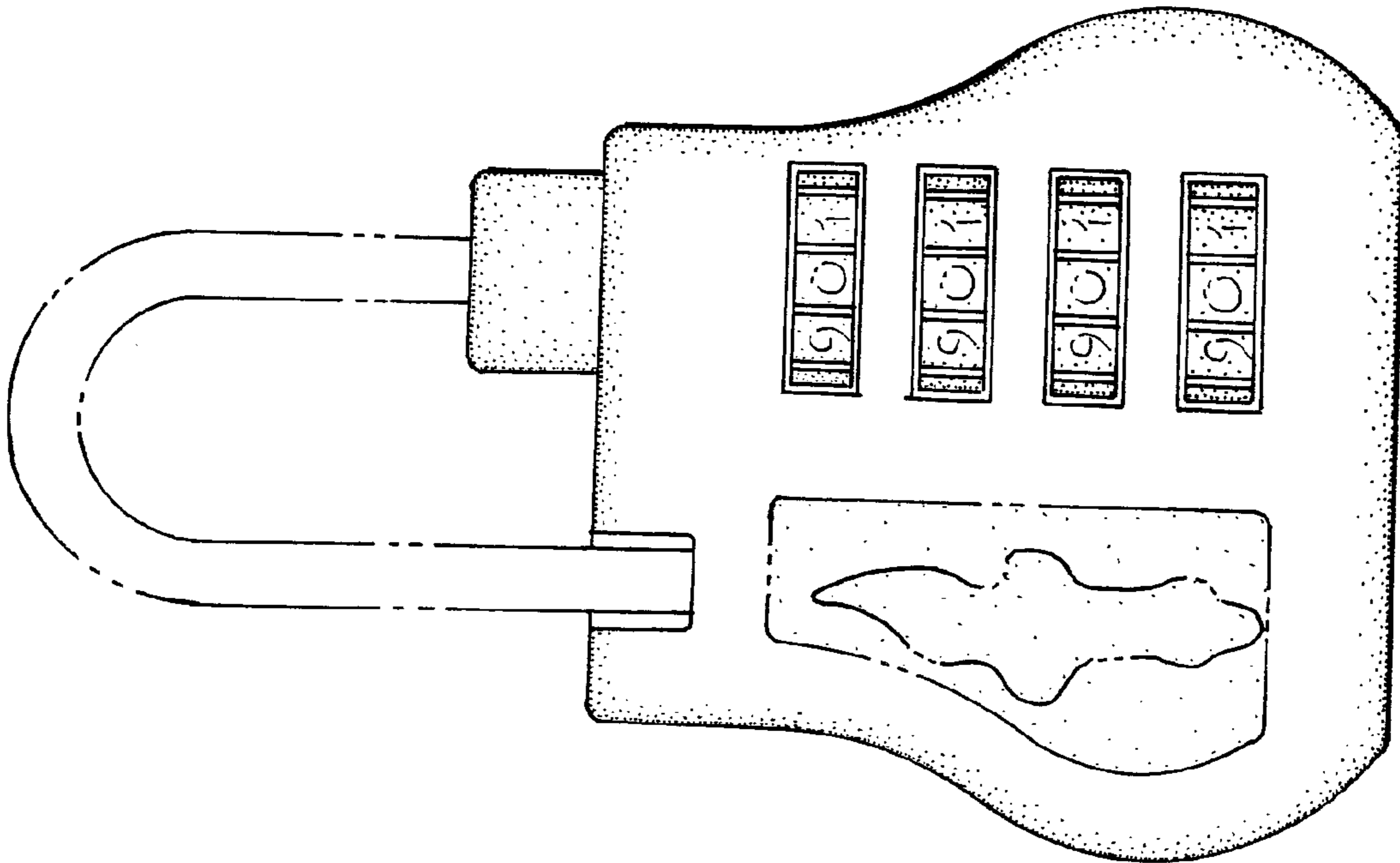

FIG. 15

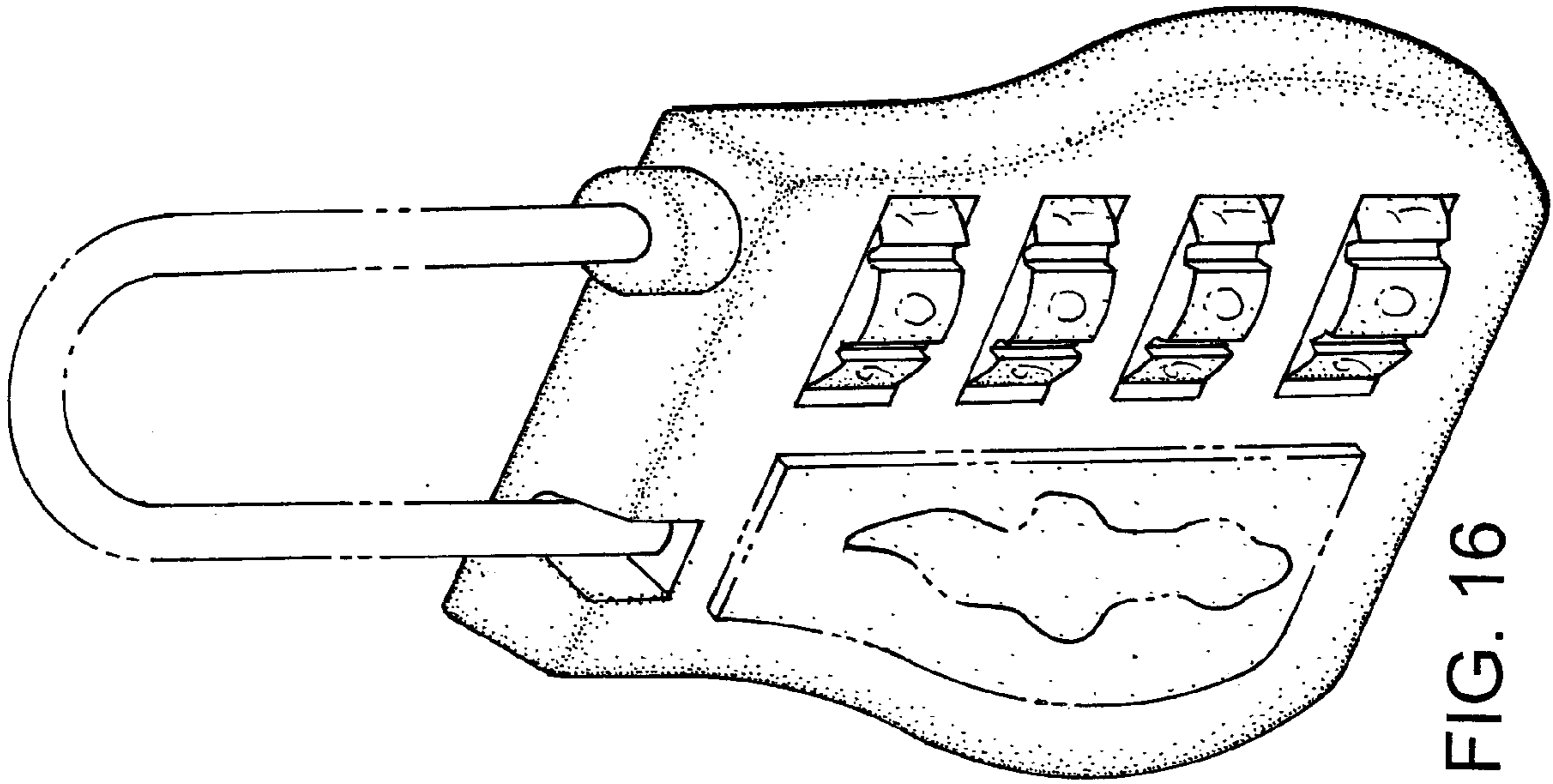

FIG. 16

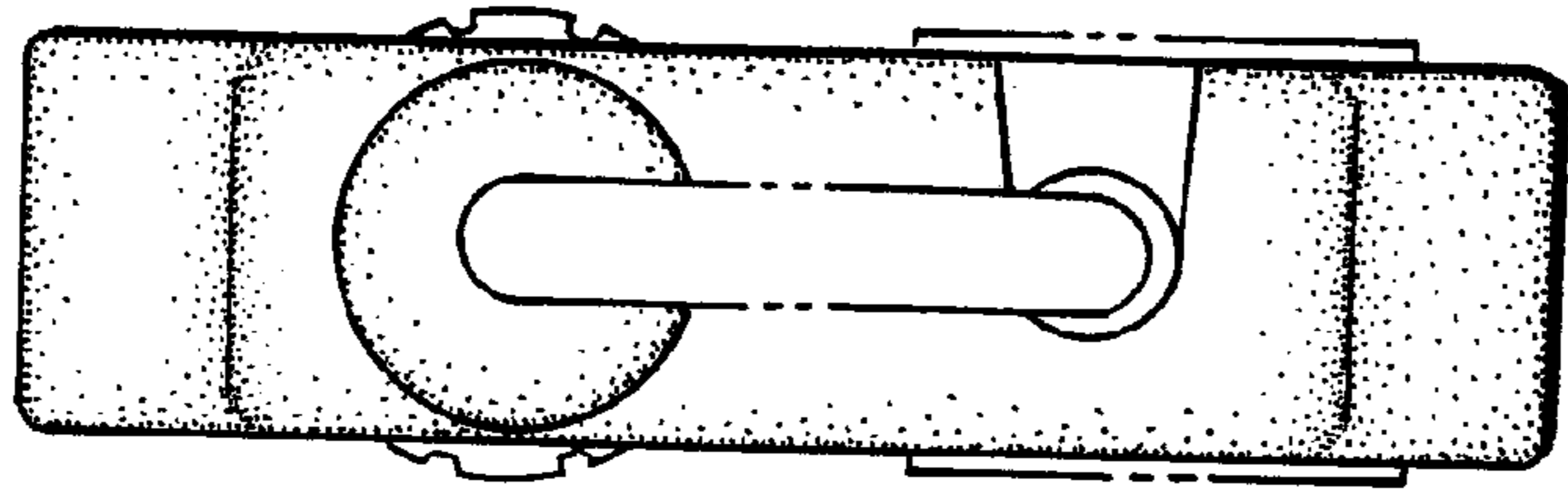

FIG. 17

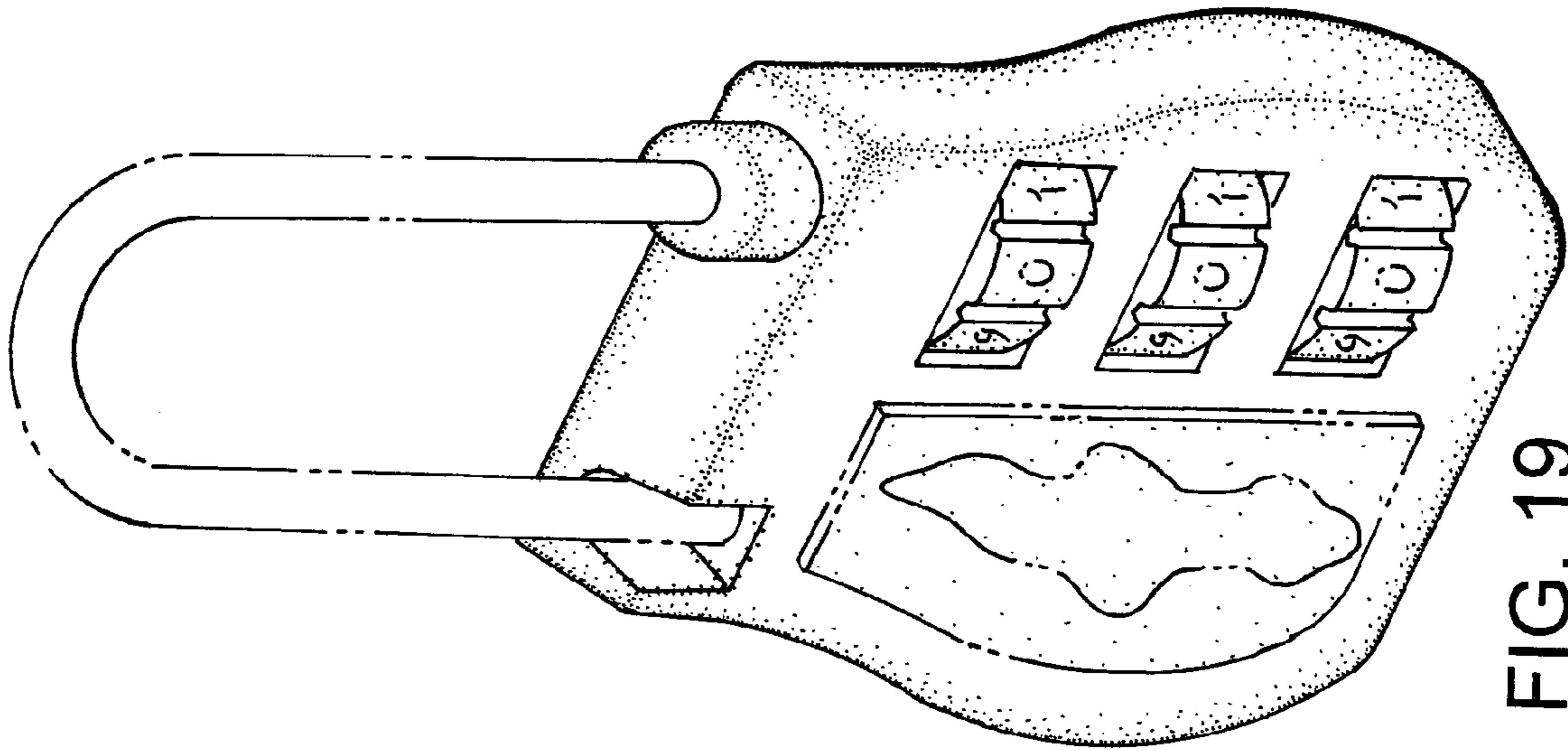

FIG. 19

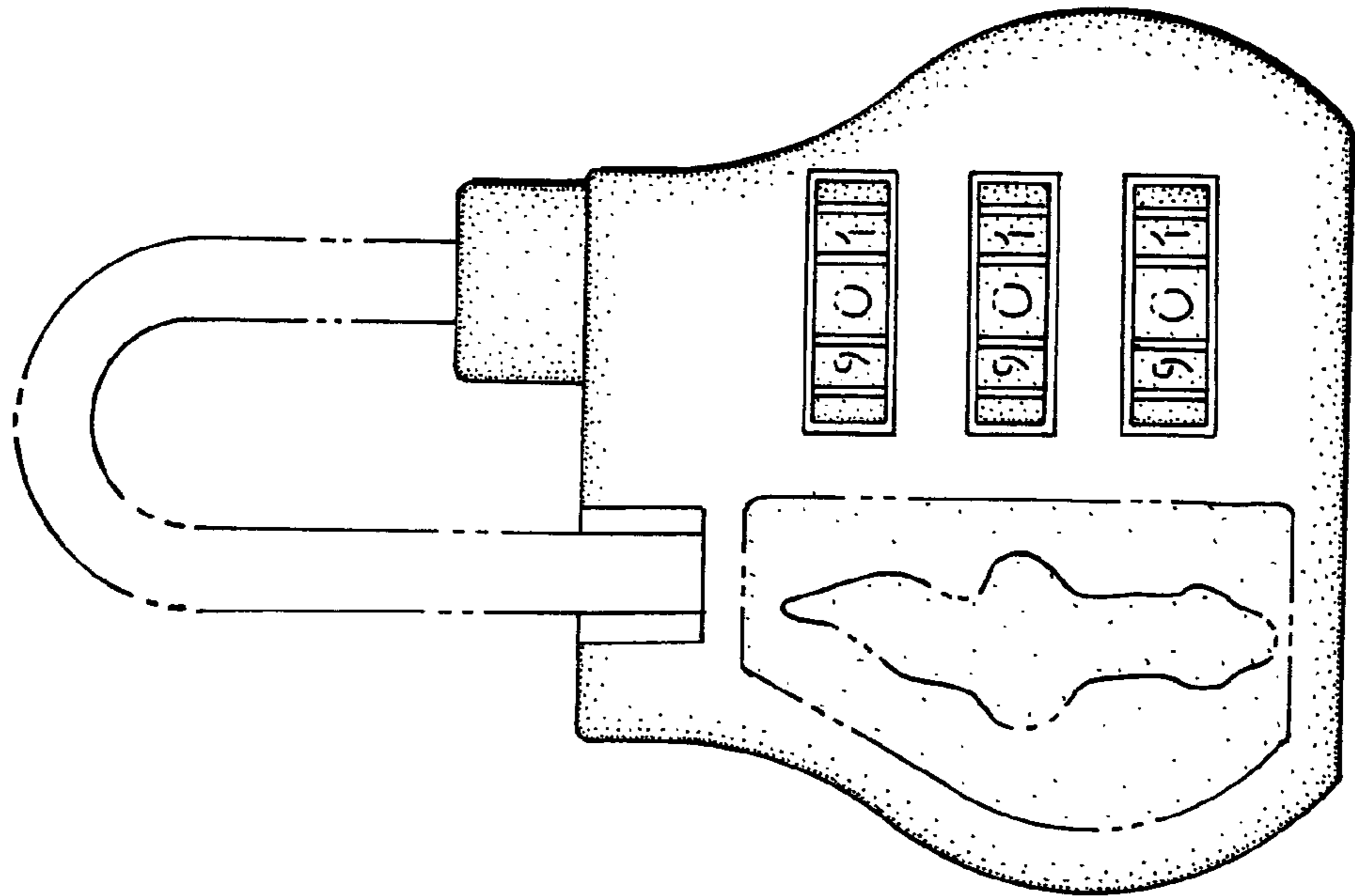

FIG. 18

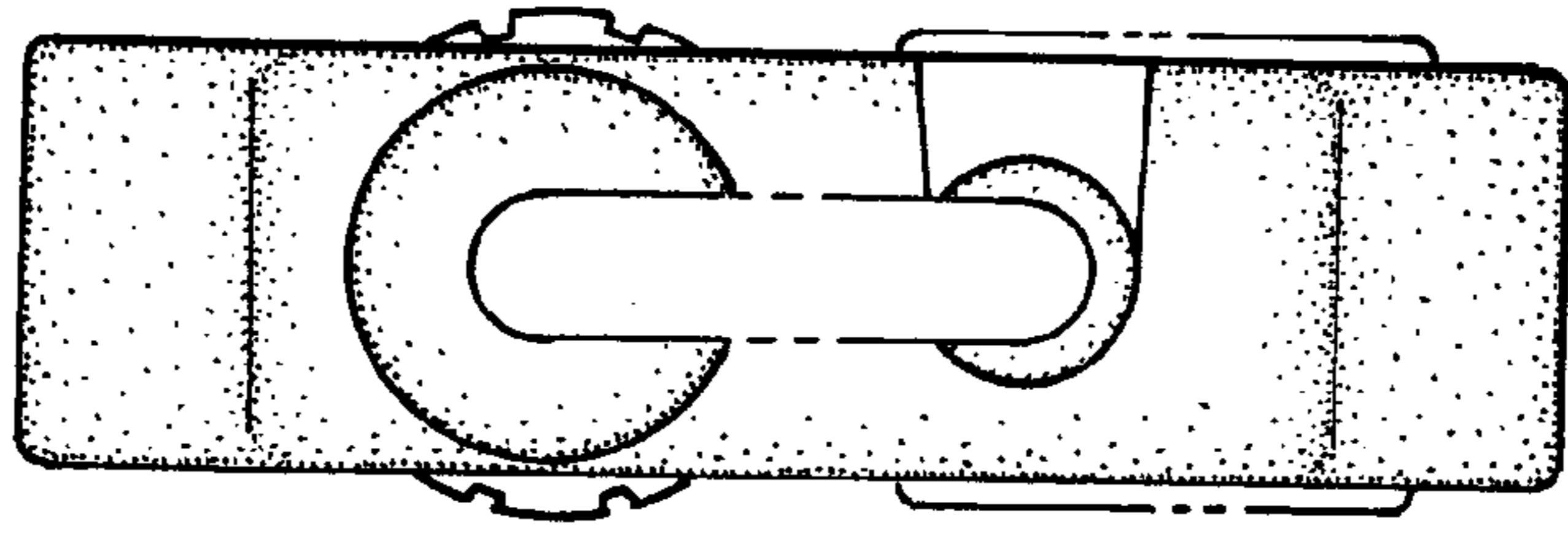

FIG. 20