



US00D548386S

(12) **United States Design Patent**
McDowell

(10) **Patent No.:** **US D548,386 S**

(45) **Date of Patent:** **** Aug. 7, 2007**

(54) **LAMPSHADE**

(75) Inventor: **Mark McDowell**, Davie, FL (US)

(73) Assignee: **Blumberg Industries, Inc.**, Miami Lakes, FL (US)

(**) Term: **14 Years**

(21) Appl. No.: **29/270,738**

(22) Filed: **Jan. 3, 2007**

Related U.S. Application Data

(62) Division of application No. 29/214,854, filed on Oct. 8, 2004.

(51) **LOC (8) Cl.** **26-99**

(52) **U.S. Cl.** **D26/118**

(58) **Field of Classification Search** D26/113,
D26/118, 119, 128, 120, 121, 130, 104, 67,
D26/153, 77, 37, 72, 85, 91, 105, 129; 362/228,
362/363, 317, 351, 354, 355, 356, 358, 223,
362/362

See application file for complete search history.

(56) **References Cited**

U.S. PATENT DOCUMENTS

- 41,547 A * 2/1864 Stratton D26/128
- 249,690 A * 11/1881 Swift 362/362
- D69,320 S * 1/1926 Hall D26/130
- 1,586,577 A * 6/1926 Raitt 362/356
- 1,955,684 A * 4/1934 Rezofsky 362/444
- D114,108 S 4/1939 Manning
- 2,230,186 A 1/1941 Johns et al.
- 2,538,676 A 1/1951 Enright
- 2,637,805 A 5/1953 Jacobs
- 2,711,476 A 6/1955 Wells
- 2,713,632 A 7/1955 Fine
- D201,295 S * 6/1965 Robichaud D26/58
- 3,222,517 A * 12/1965 Peter 362/350
- 3,239,662 A 3/1966 Noller
- D204,899 S 5/1966 Currey
- D218,474 S * 8/1970 Devine D26/131
- 3,666,934 A * 5/1972 Moore 362/294

- D226,327 S * 2/1973 Anderson D26/67
- D244,875 S 6/1977 Baca
- D246,269 S * 11/1977 Baker D26/129
- 4,079,245 A * 3/1978 Baker 362/355
- 4,233,656 A * 11/1980 Shemitz 362/352
- 4,290,099 A 9/1981 Vicars-Harris
- 4,344,115 A 8/1982 Pickens et al.
- D287,107 S 12/1986 Bergeron et al.
- D294,645 S 3/1988 Ewing et al.
- 4,731,716 A * 3/1988 Chang 362/352
- D298,861 S * 12/1988 Ewing et al. D26/71
- D323,037 S * 1/1992 Edwards D26/118
- D345,024 S * 3/1994 Fox D26/58
- 5,375,048 A 12/1994 Barnes
- D377,402 S * 1/1997 Perkins D25/135
- D385,650 S * 10/1997 Okros D26/120
- D396,319 S * 7/1998 Sutton D26/128
- D416,099 S * 11/1999 Hardy D26/9
- D417,026 S * 11/1999 Taylor et al. D26/67
- 6,000,817 A * 12/1999 Chan 362/352
- D429,360 S 8/2000 Chelf et al.
- D434,518 S * 11/2000 Rivers D26/110
- D438,327 S 2/2001 Chelf et al.
- D447,272 S * 8/2001 Smith D26/118
- D463,613 S * 9/2002 Block D26/142
- 6,474,831 B1 11/2002 Ruuttu et al.
- 6,537,063 B1 3/2003 Pecoskie
- D477,892 S * 7/2003 Alduby D26/118
- D482,158 S * 11/2003 Velikov et al. D26/128
- 6,652,124 B2 * 11/2003 Schubert et al. 362/285
- 6,669,468 B2 12/2003 Pesu
- 6,742,915 B1 6/2004 Westerheide
- D495,822 S 9/2004 Yoneda
- 6,793,377 B2 9/2004 Chu
- 2003/0064337 A1 4/2003 Pesu
- 2003/0218883 A1 * 11/2003 Thevenot 362/362

OTHER PUBLICATIONS

Lumicube, lighting designs by Michael Seal; "LUMISHADES"; www.lumicube.com/pages/lumishades.html; 2002.*

Global Lighting; "eda c"; <http://globallighting.net/product.htm?c=3&p=63>; 2004.*

* cited by examiner

Primary Examiner—Freda S. Nunn

Assistant Examiner—Kevin K. Rudzinski

(74) *Attorney, Agent, or Firm*—McCormick, Paulding & Huber LLP

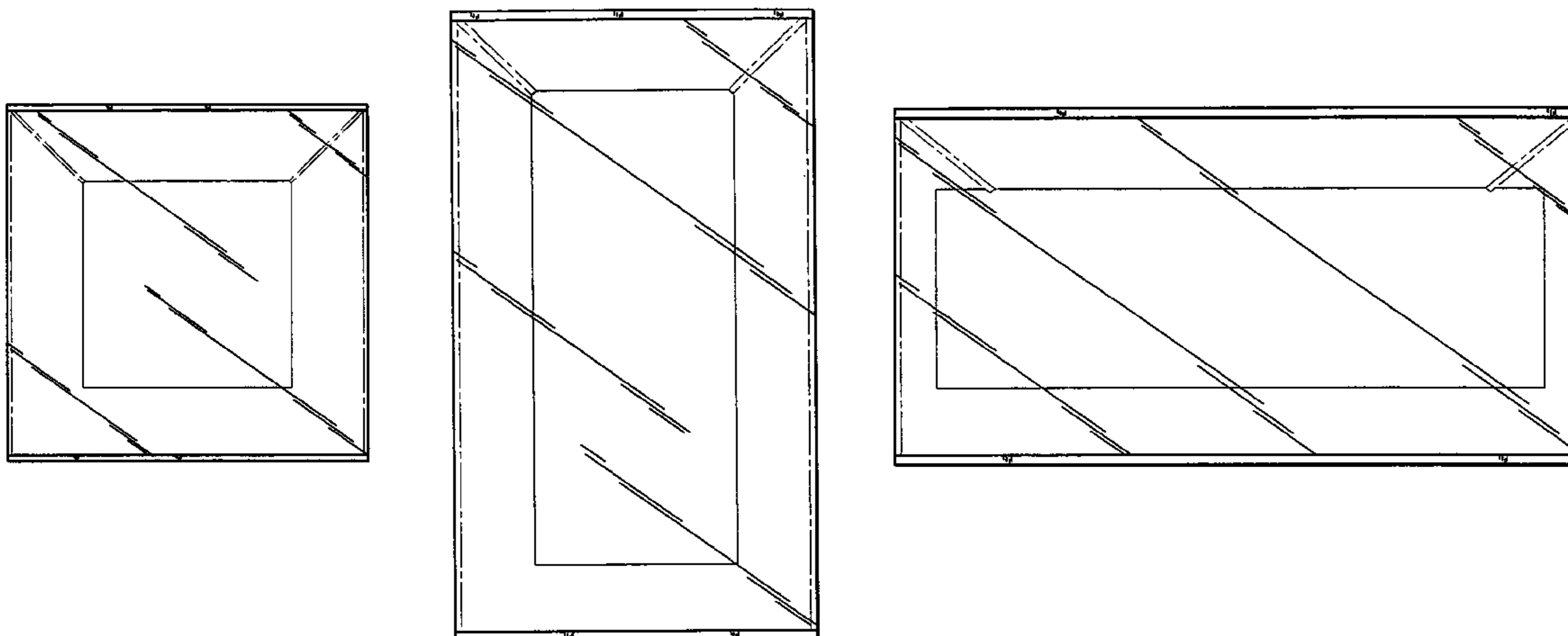

(57)

CLAIM

The ornamental design for a lampshade, as shown and described.

DESCRIPTION

FIG. 1 is a front view of a lampshade comprising a first embodiment of the new, original and ornamental design, the rear, left-hand and right-hand side views being a mirror image thereof.

FIG. 2 is a bottom view of a lampshade comprising the first embodiment of the new, original and ornamental design.

FIG. 3 is a top view of a lampshade comprising the first embodiment of the new, original and ornamental design.

FIG. 4 is a front view of a lampshade comprising a second embodiment of the new, original and ornamental design, the rear, left-hand and right-hand side views being a mirror image thereof.

FIG. 5 is a bottom view of a lampshade comprising the second embodiment of the new, original and ornamental design.

FIG. 6 is a top view of a lampshade comprising the second embodiment of the new, original and ornamental design.

FIG. 7 is a front view of a lampshade comprising a third embodiment of the new, original and ornamental design, the rear, left-hand and right-hand side views being a mirror image thereof.

FIG. 8 is a bottom view of a lampshade comprising the third embodiment of the new, original and ornamental design.

FIG. 9 is a top view of a lampshade comprising the third embodiment of the new, original and ornamental design.

FIG. 10 is a front view of a lampshade comprising a fourth embodiment of the new, original and ornamental design, the rear, left-hand and right-hand side views being a mirror image thereof.

FIG. 11 is a bottom view of a lampshade comprising the fourth embodiment of the new, original and ornamental design.

FIG. 12 is a top view of a lampshade comprising the fourth embodiment of the new, original and ornamental design.

FIG. 13 is a front view of a lampshade comprising a fifth embodiment of the new, original and ornamental design, the rear, left-hand and right-hand side views being a mirror image thereof.

FIG. 14 is a bottom view of a lampshade comprising the fifth embodiment of the new, original and ornamental design.

FIG. 15 is a top view of a lampshade comprising the fifth embodiment of the new, original and ornamental design.

FIG. 16 is a front view of a lampshade comprising a sixth embodiment of the new, original and ornamental design, the rear, left-hand and right-hand side views being a mirror image thereof.

FIG. 17 is a bottom view of a lampshade comprising the sixth embodiment of the new, original and ornamental design.

FIG. 18 is a top view of a lampshade comprising the sixth embodiment of the new, original and ornamental design.

FIG. 19 is a front view of a lampshade comprising a seventh embodiment of the new, original and ornamental design, the rear, left-hand and right-hand side views being a mirror image thereof.

FIG. 20 is a bottom view of a lampshade comprising the seventh embodiment of the new, original and ornamental design.

FIG. 21 is a top view of a lampshade comprising the seventh embodiment of the new, original and ornamental design.

FIG. 22 is a front view of a lampshade comprising an eighth embodiment of the new, original and ornamental design, the rear, left-hand and right-hand side views being a mirror image thereof.

FIG. 23 is a bottom view of a lampshade comprising the eighth embodiment of the new, original and ornamental design.

FIG. 24 is a top view of a lampshade comprising the eighth embodiment of the new, original and ornamental design.

FIG. 25 is a front view of a lampshade comprising the ninth embodiment of the new, original and ornamental design, the rear view being a mirror image thereof.

FIG. 26 is a right-hand side view of a lampshade comprising the ninth embodiment of the new, original and ornamental design, the left-hand being a mirror image thereof.

FIG. 27 is a bottom view of a lampshade comprising the ninth embodiment of the new, original and ornamental design.

FIG. 28 is a top view of the lampshade comprising the ninth embodiment of the new, original and ornamental design.

FIG. 29 is a front view of a lampshade comprising the tenth embodiment of the new, original and ornamental design, the rear view being a mirror image thereof.

FIG. 30 is a right-hand side view of a lampshade comprising the tenth embodiment of the new, original and ornamental design, the left-hand being a mirror image thereof.

FIG. 31 is a bottom view of a lampshade comprising the tenth embodiment of the new, original and ornamental design.

FIG. 32 is a top view of a lampshade comprising the tenth embodiment of the new, original and ornamental design.

FIG. 33 is a front view of a lampshade comprising the eleventh embodiment of the new, original and ornamental design, the rear view being a mirror image thereof.

FIG. 34 is a right-hand side view of a lampshade comprising the eleventh embodiment of the new, original and ornamental design, the left-hand being a mirror image thereof.

FIG. 35 is a front view of a lampshade comprising the eleventh embodiment of the new, original and ornamental design.

FIG. 36 is a top view of a lampshade comprising the eleventh embodiment of the new, original and ornamental design.

FIG. 37 is a front view of a lampshade comprising the twelfth embodiment of the new, original and ornamental design, the rear view being a mirror image thereof.

FIG. 38 is a right-hand side view of a lampshade comprising the twelfth embodiment of the new, original and ornamental design, the left-hand being a mirror image thereof.

FIG. 39 is a bottom view of a lampshade comprising the twelfth embodiment of the new, original and ornamental design; and,

FIG. 40 is a top view of a lampshade comprising the twelfth embodiment of the new, original and ornamental design.

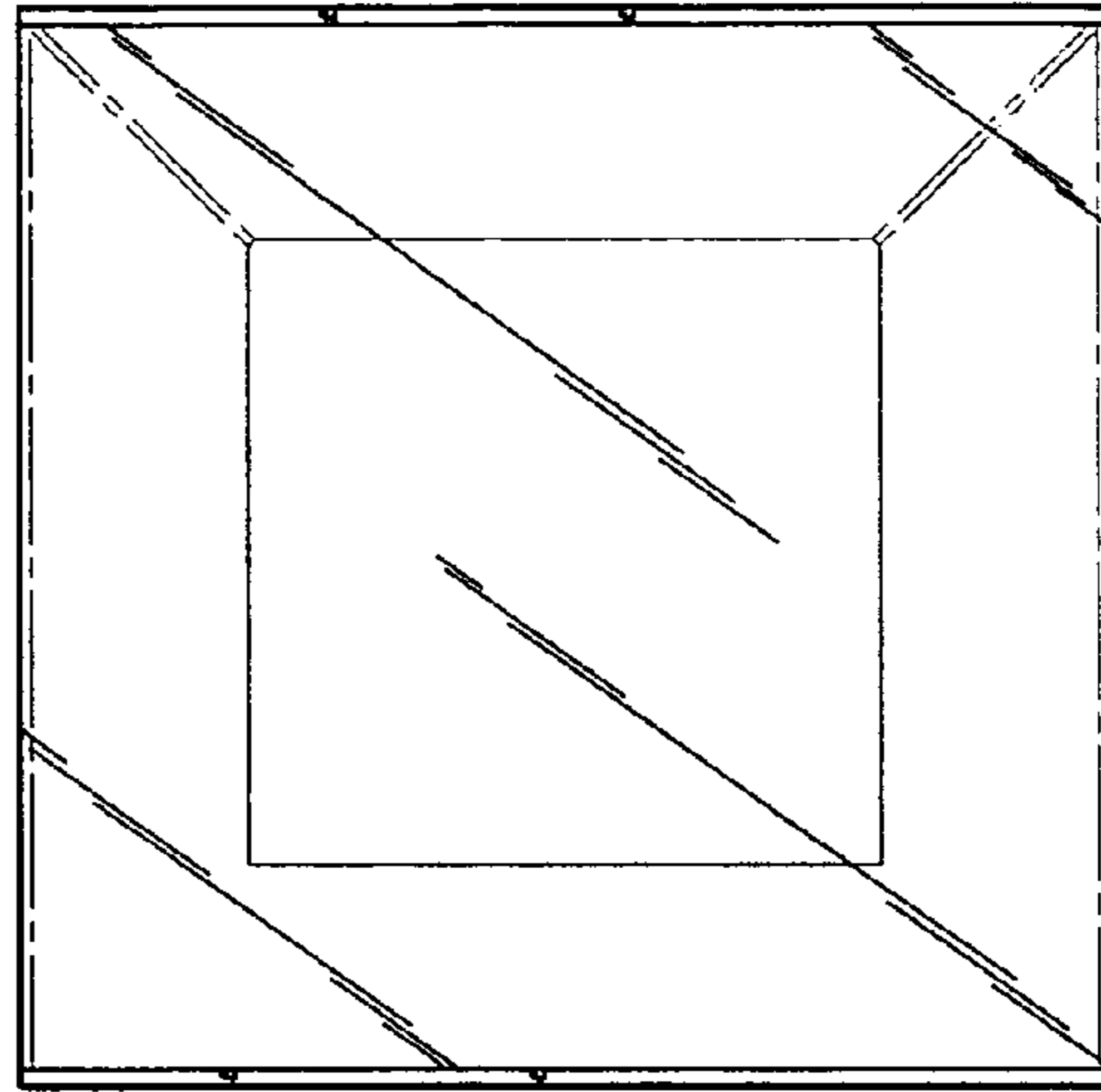

FIG. 1

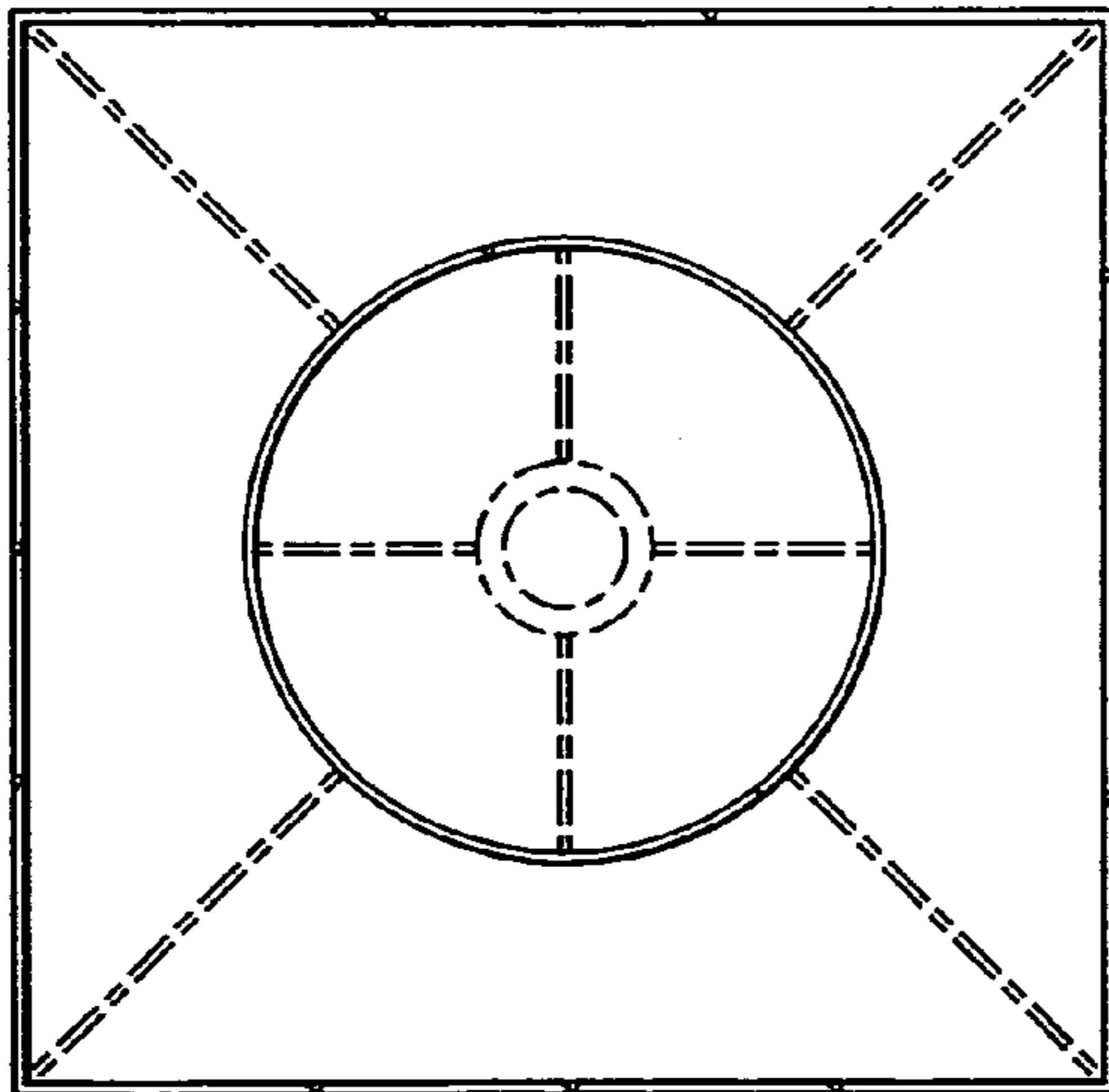

FIG. 2

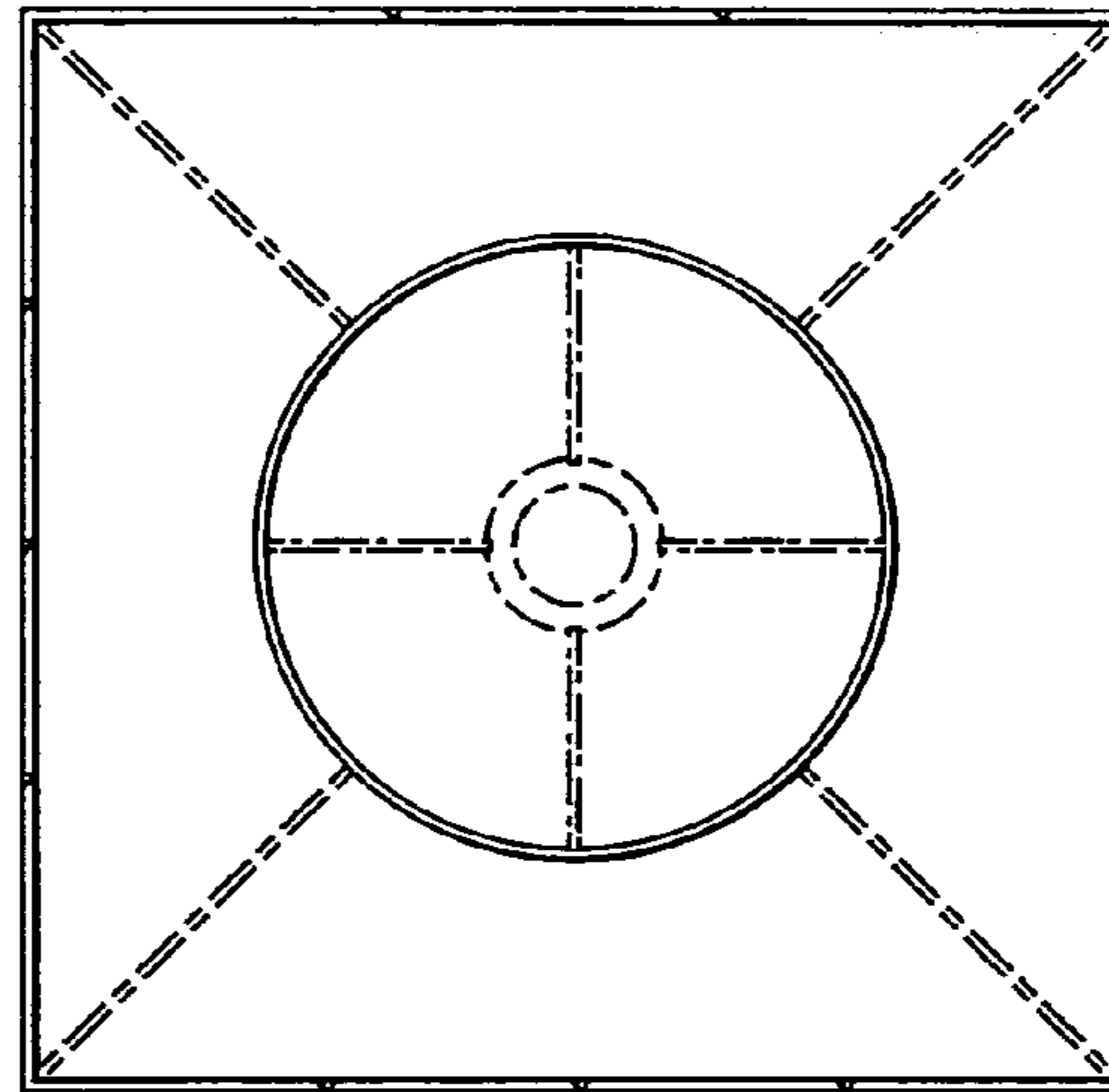

FIG. 3

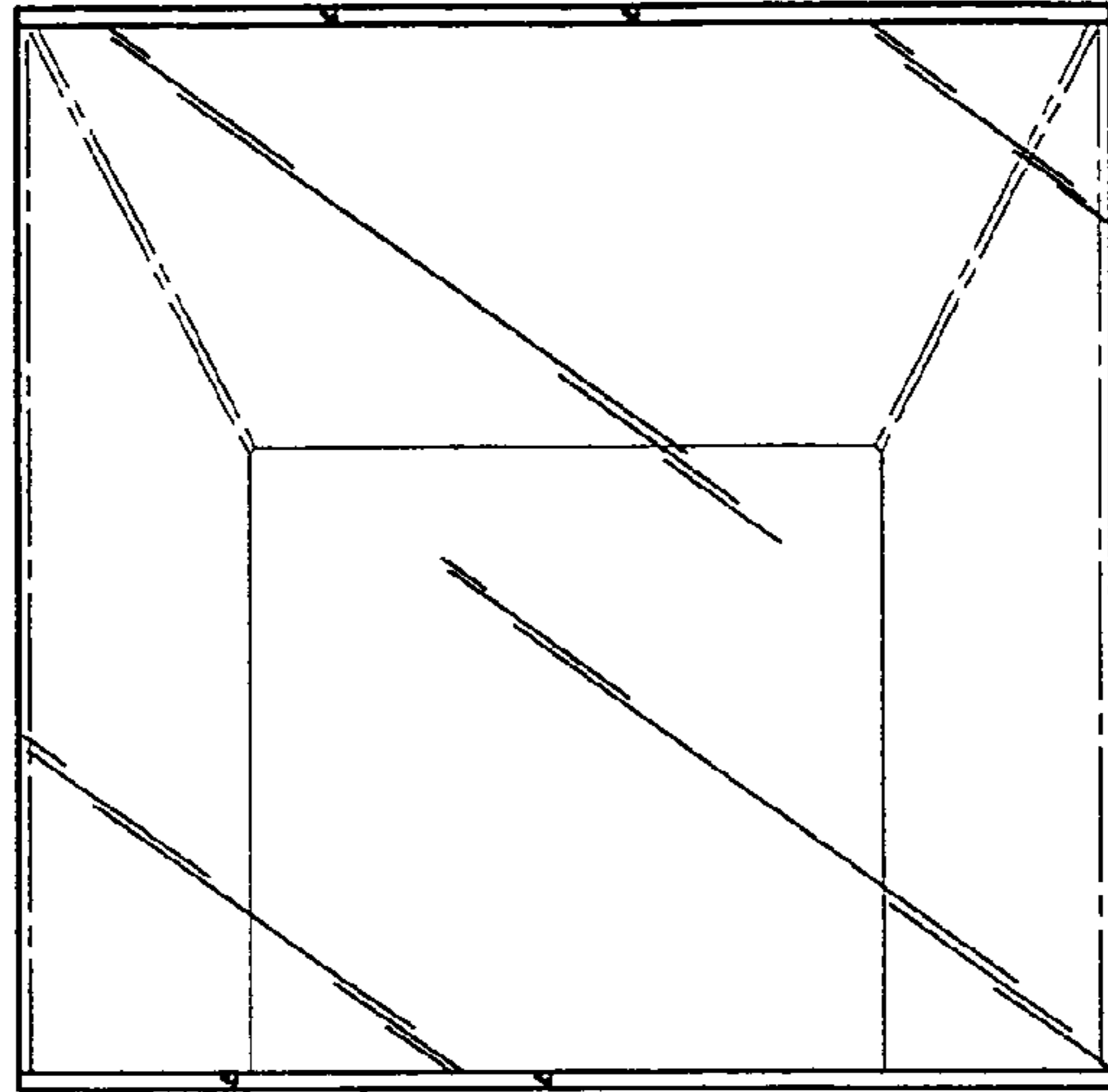

FIG. 4

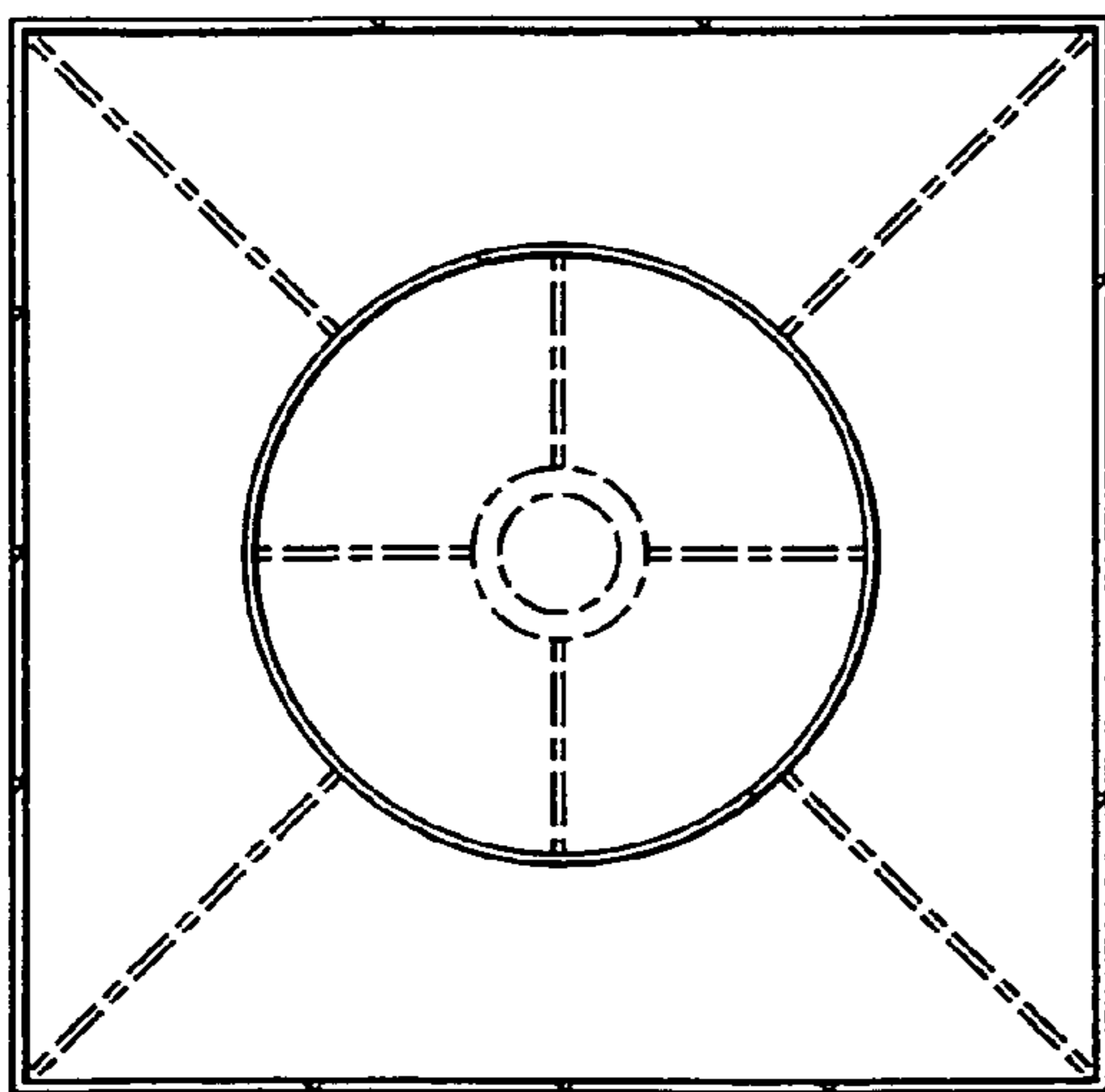

FIG. 5

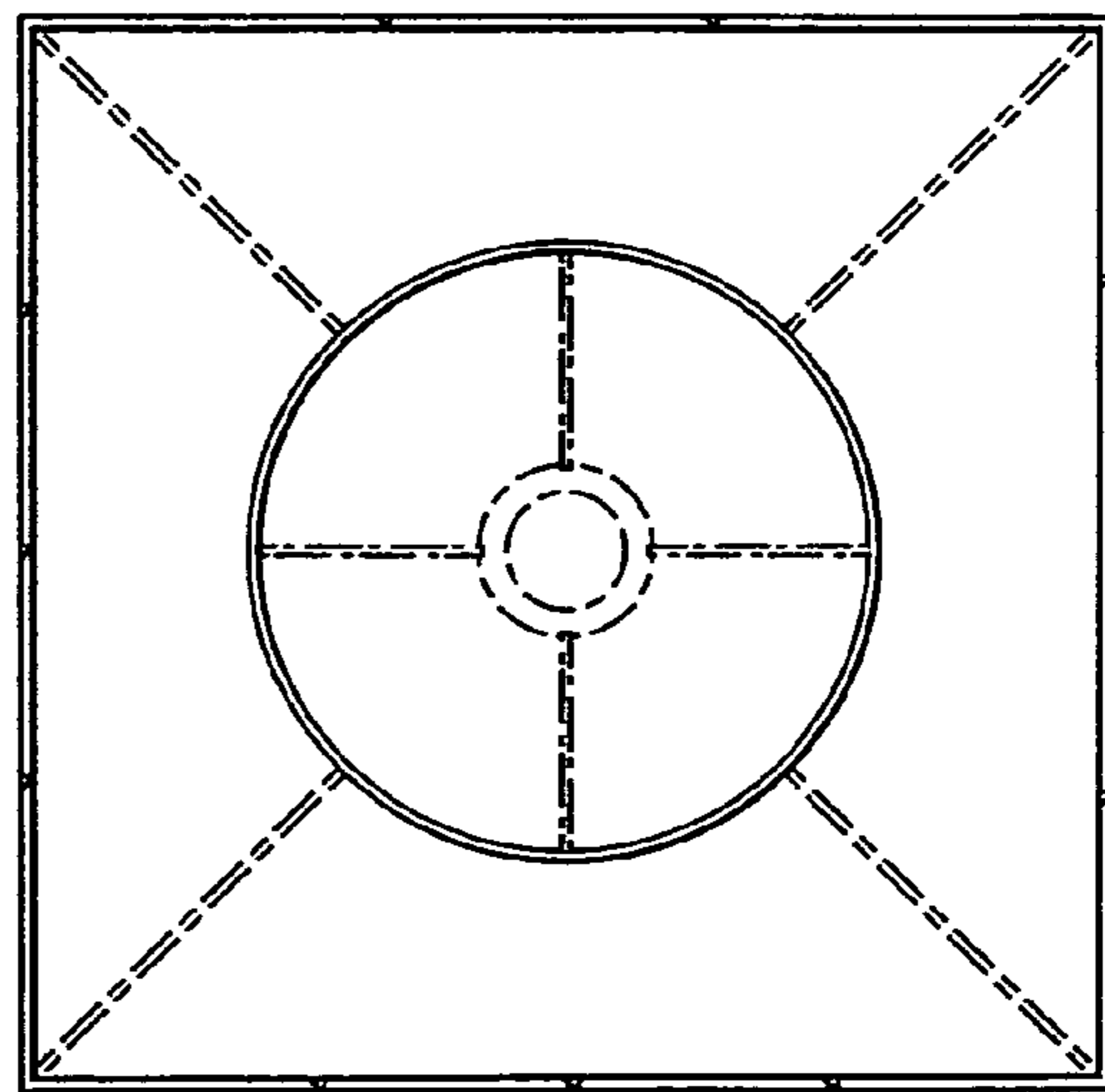

FIG. 6

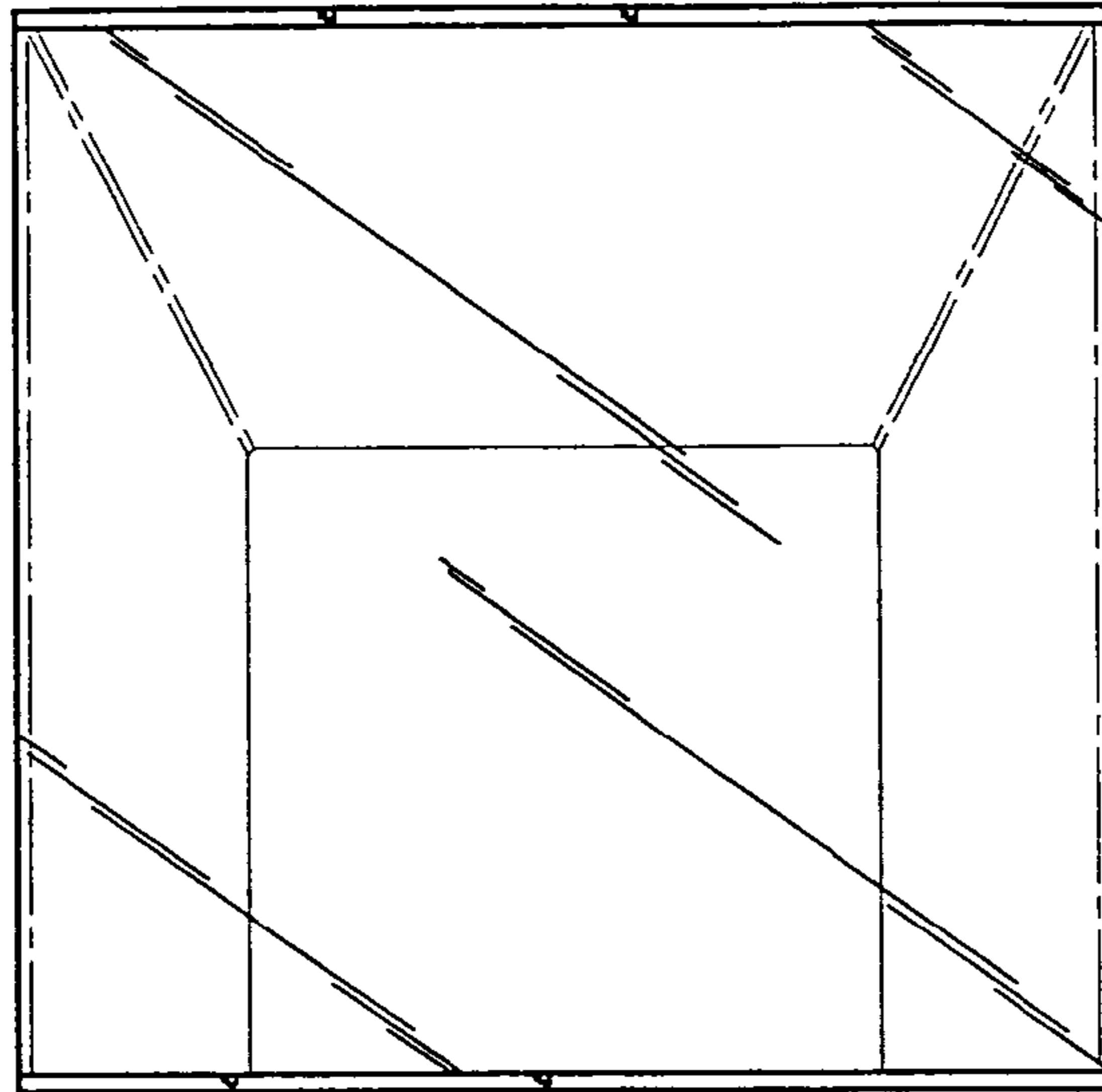

FIG. 7

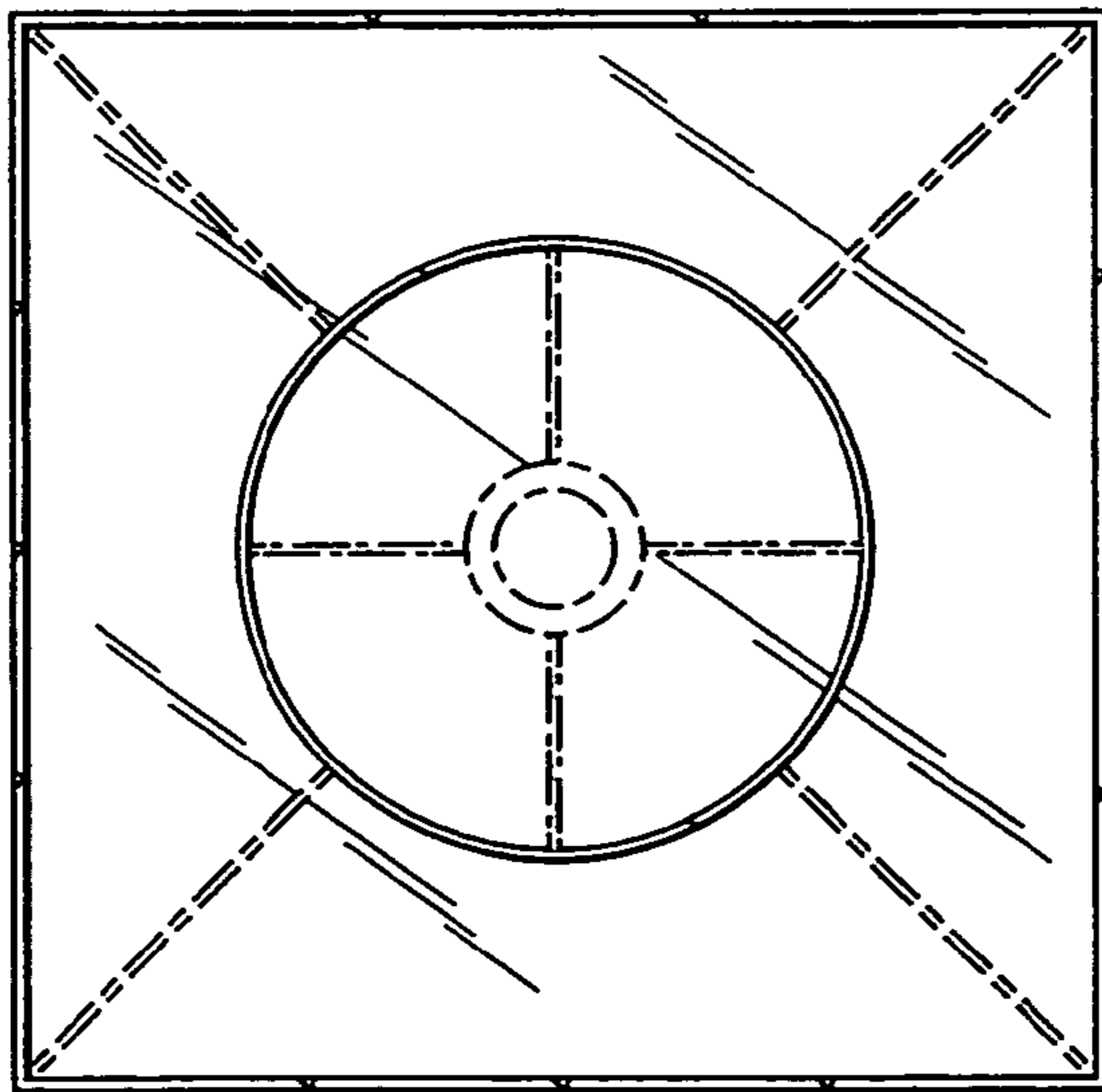

FIG. 8

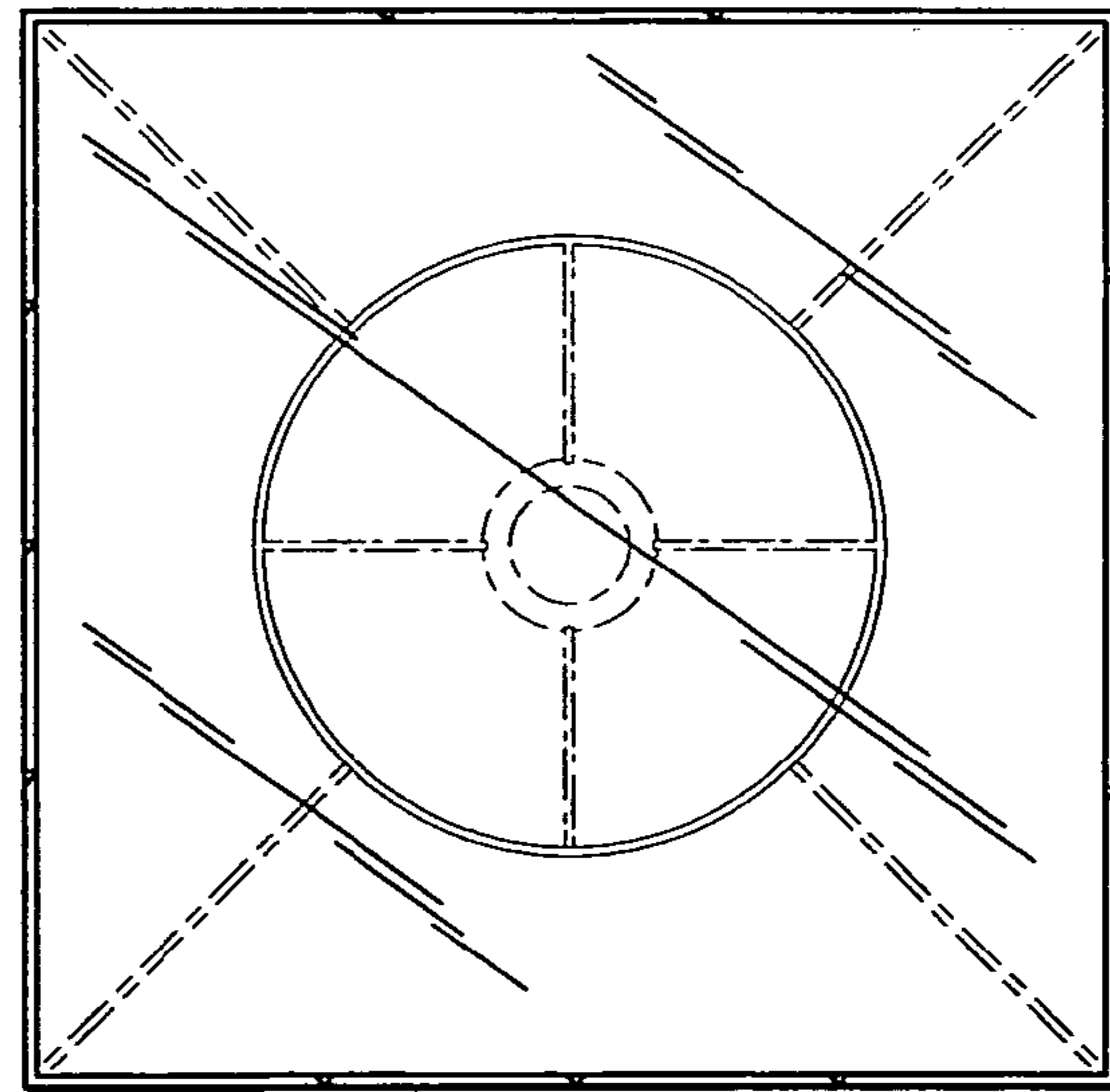

FIG. 9

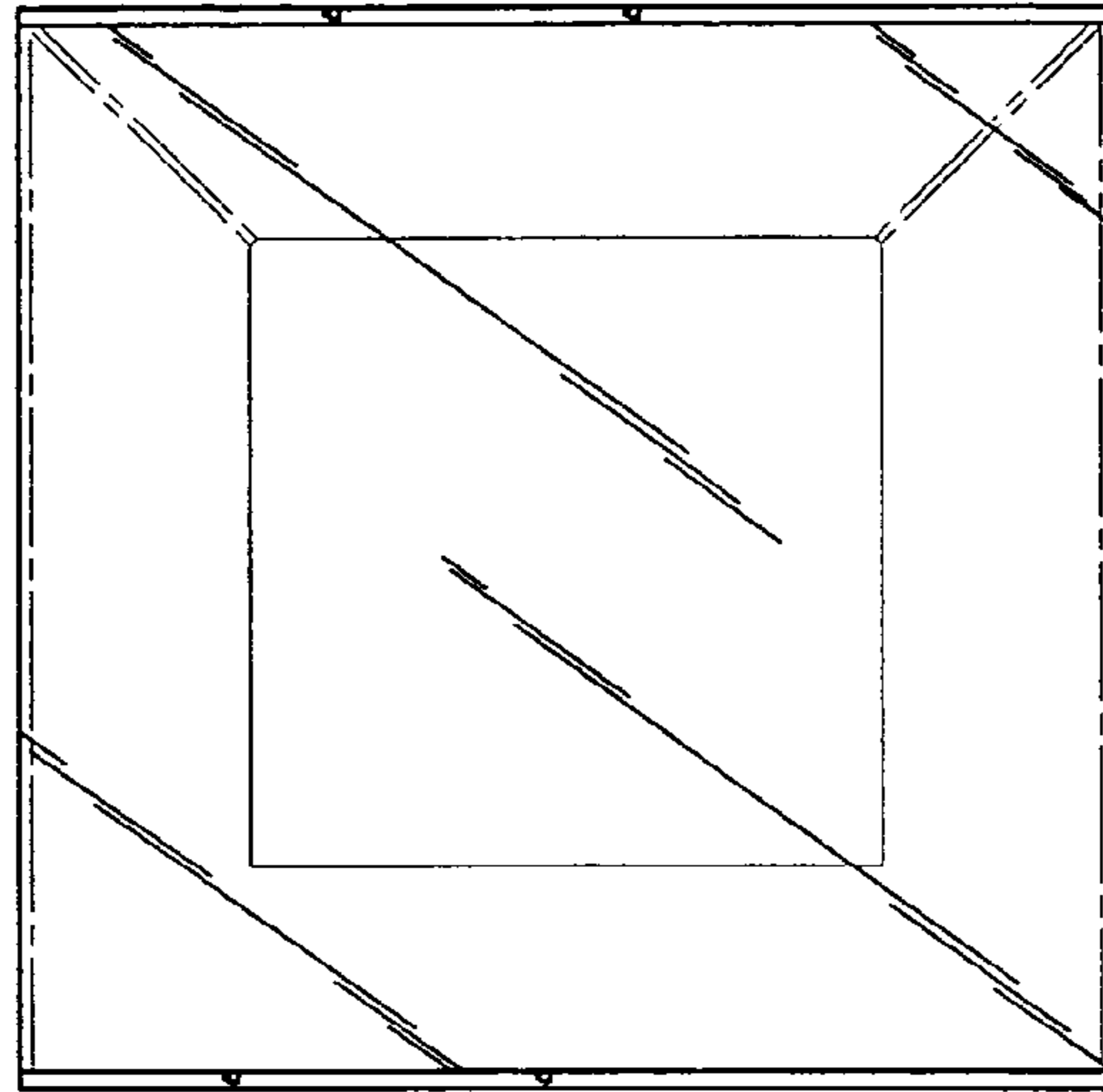

FIG. 10

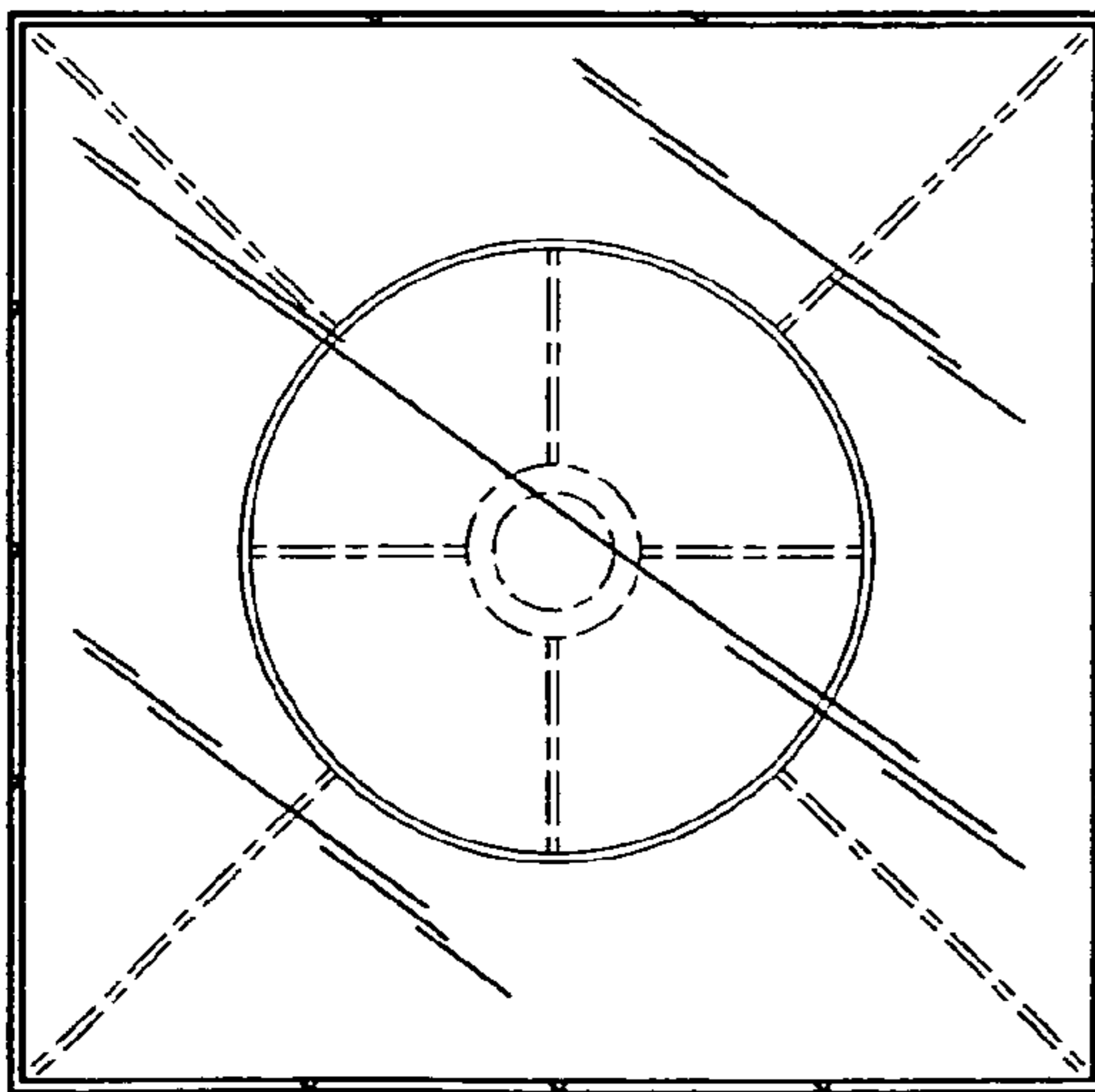

FIG. 11

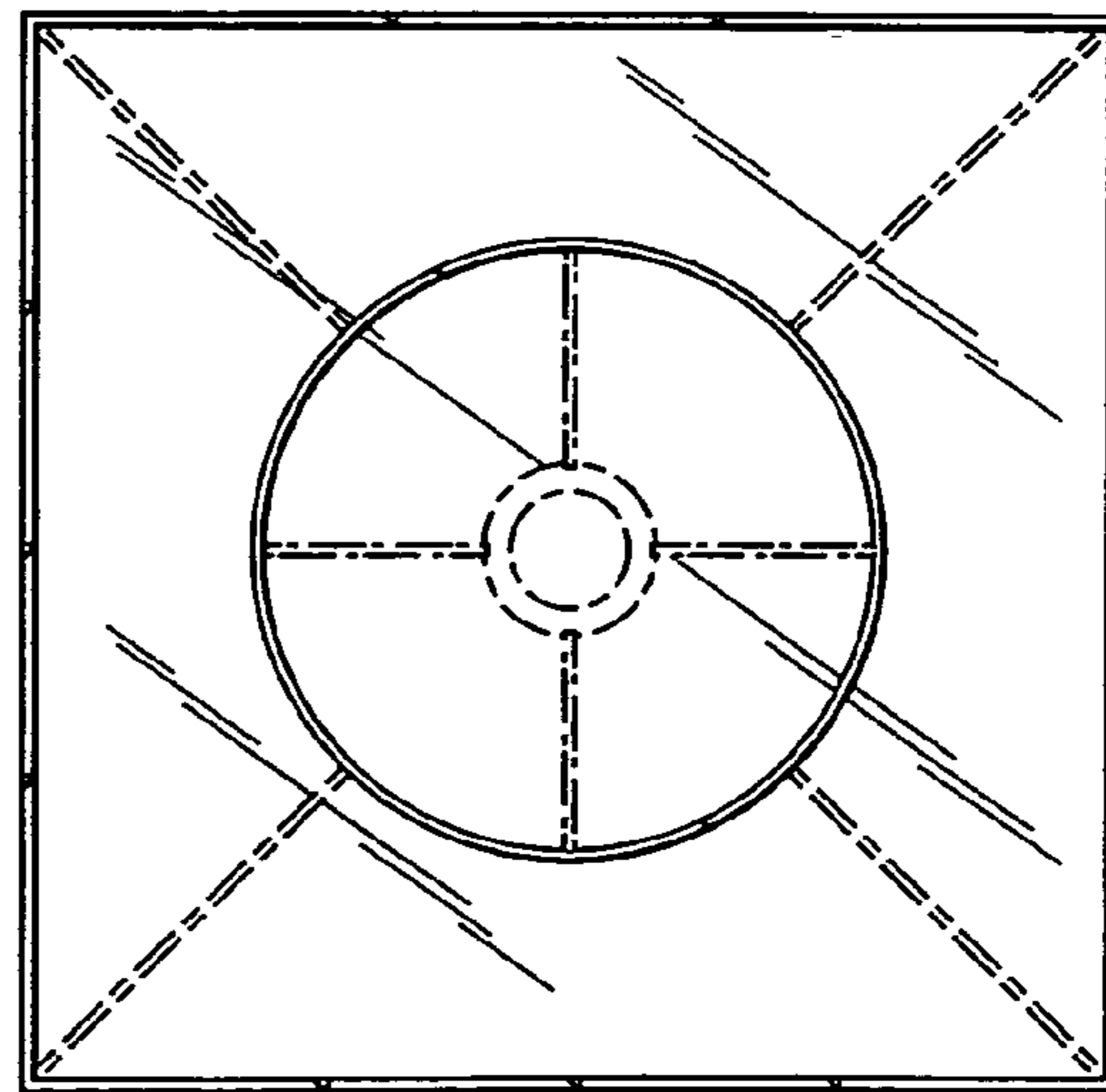

FIG. 12

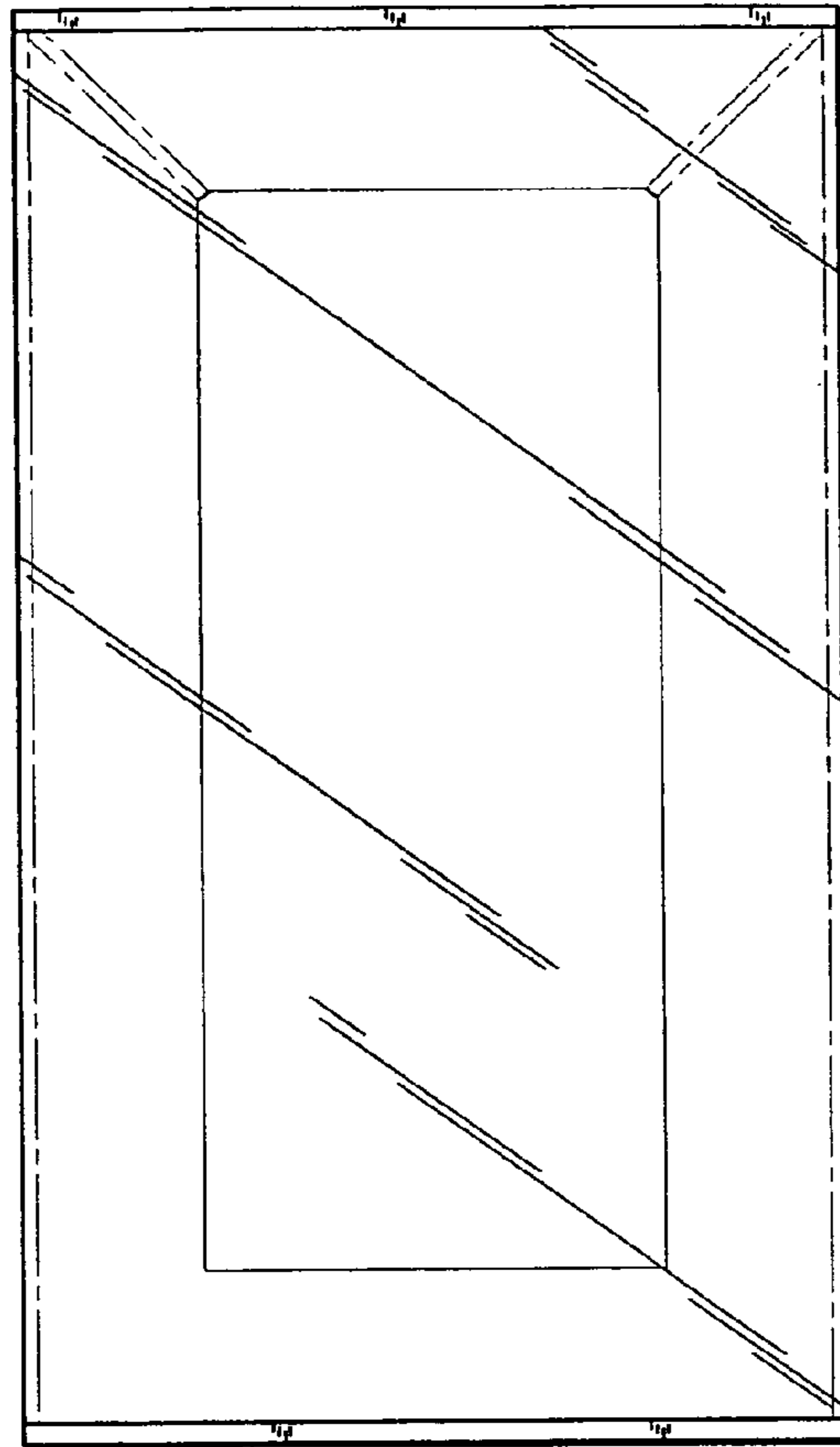

FIG. 13

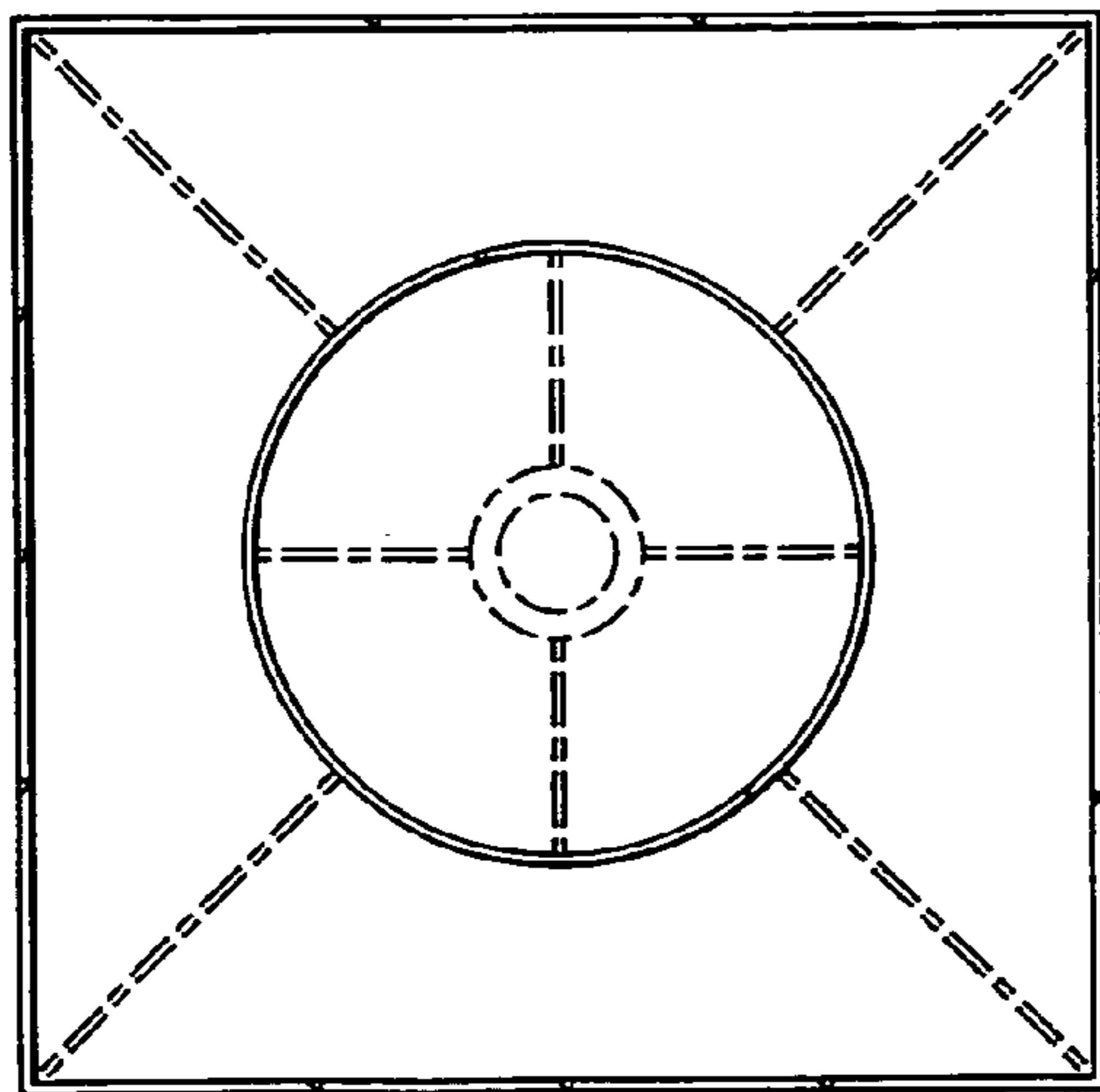

FIG. 14

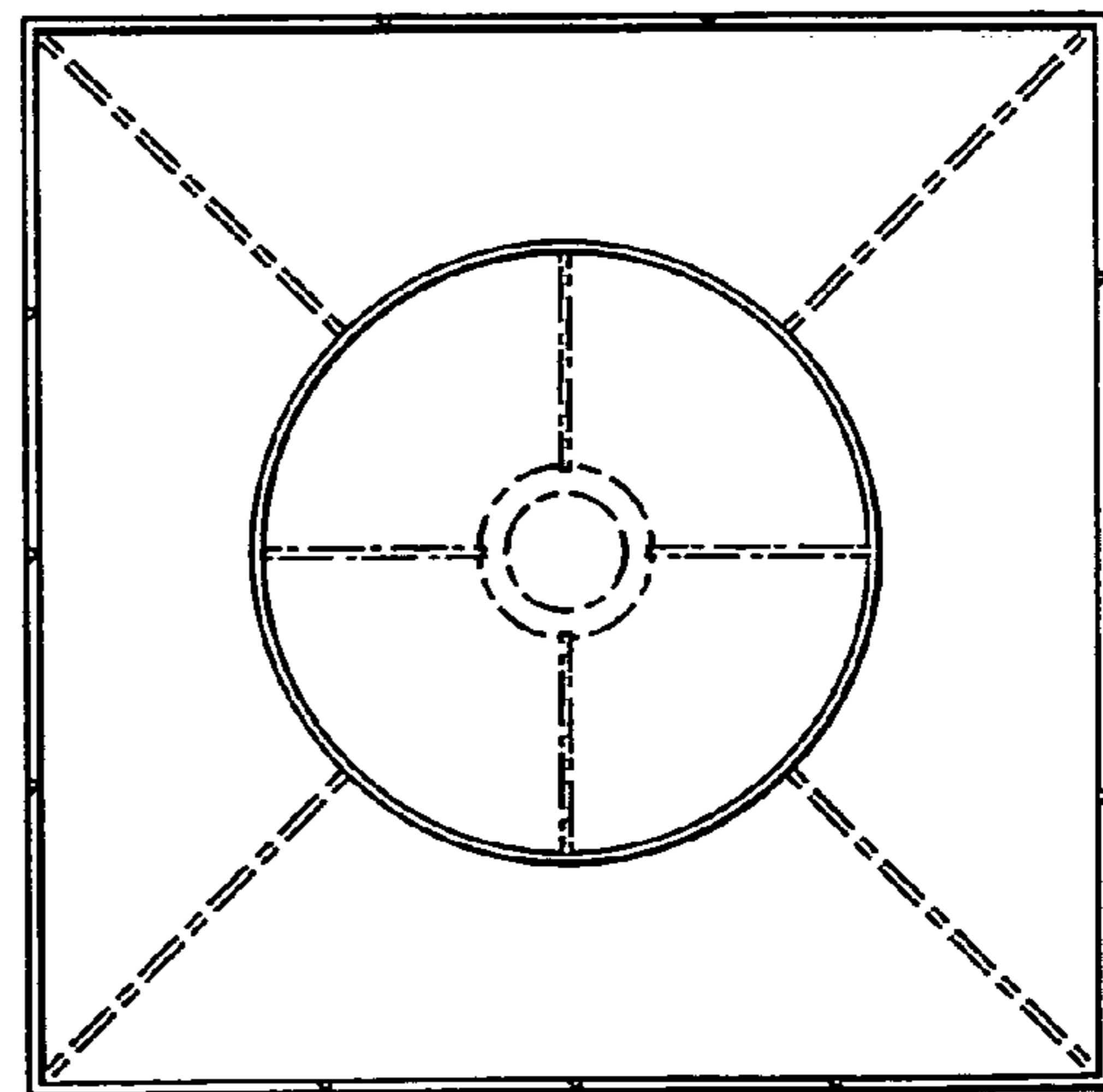

FIG. 15

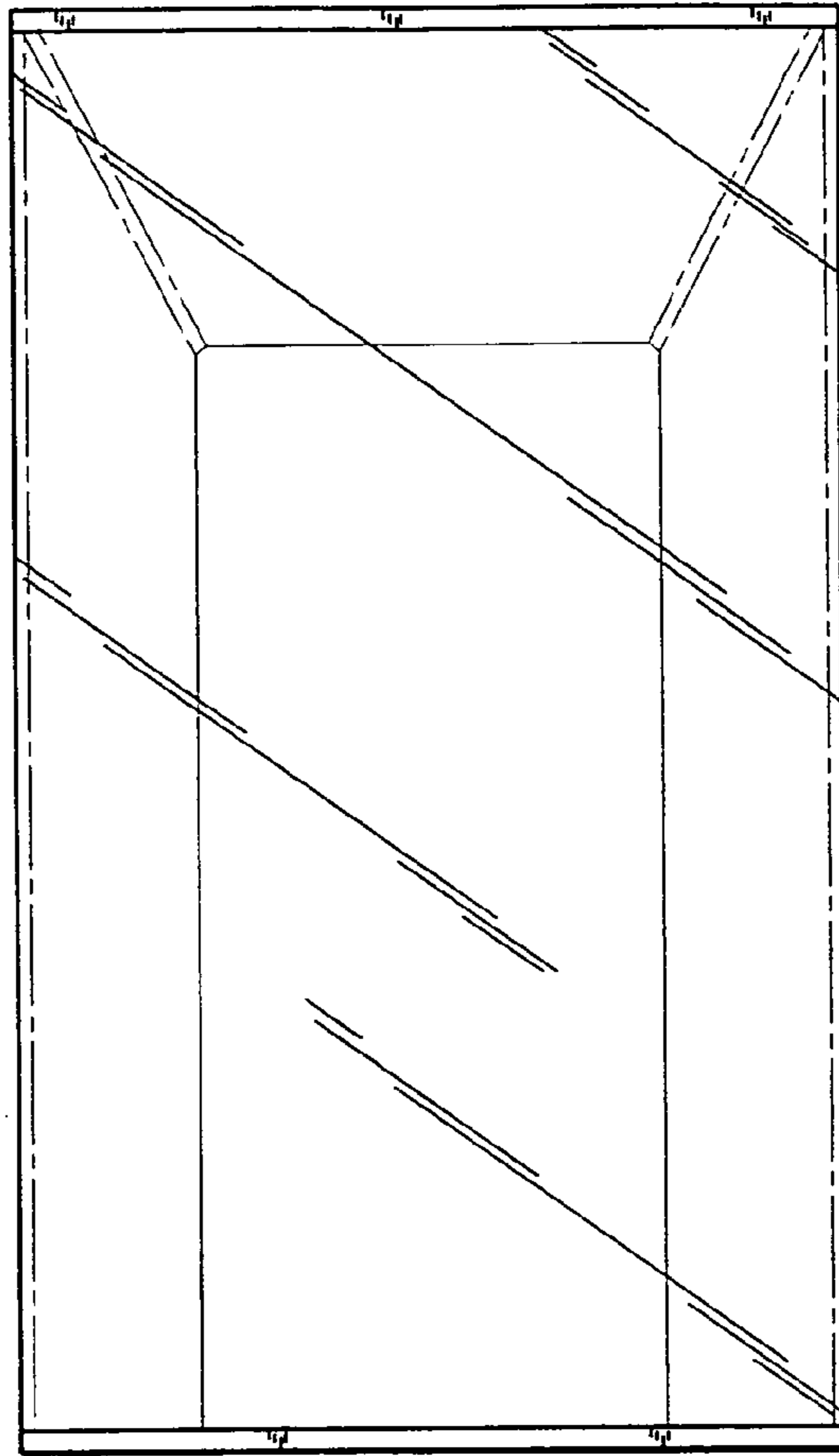

FIG. 16

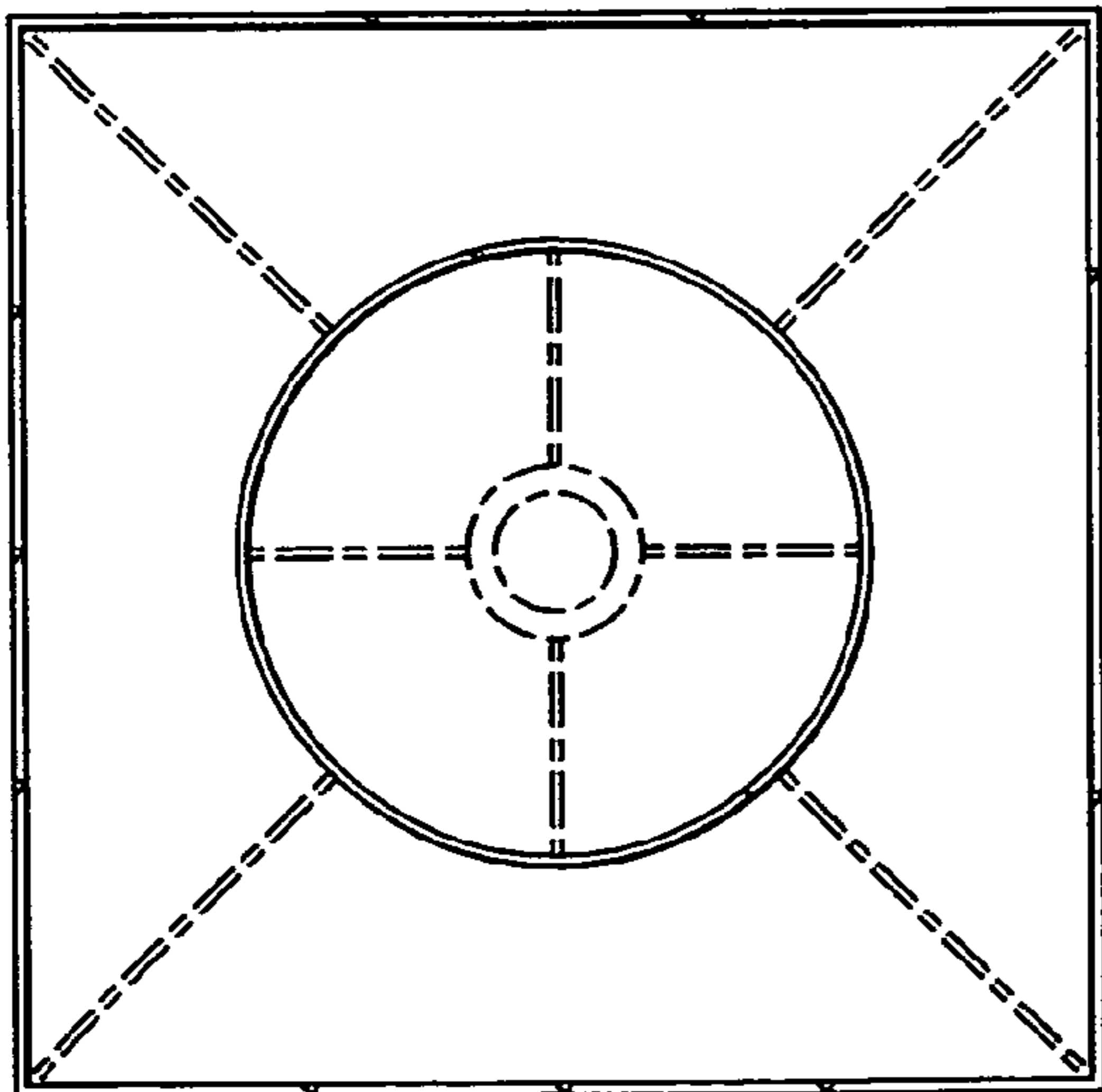

FIG. 17

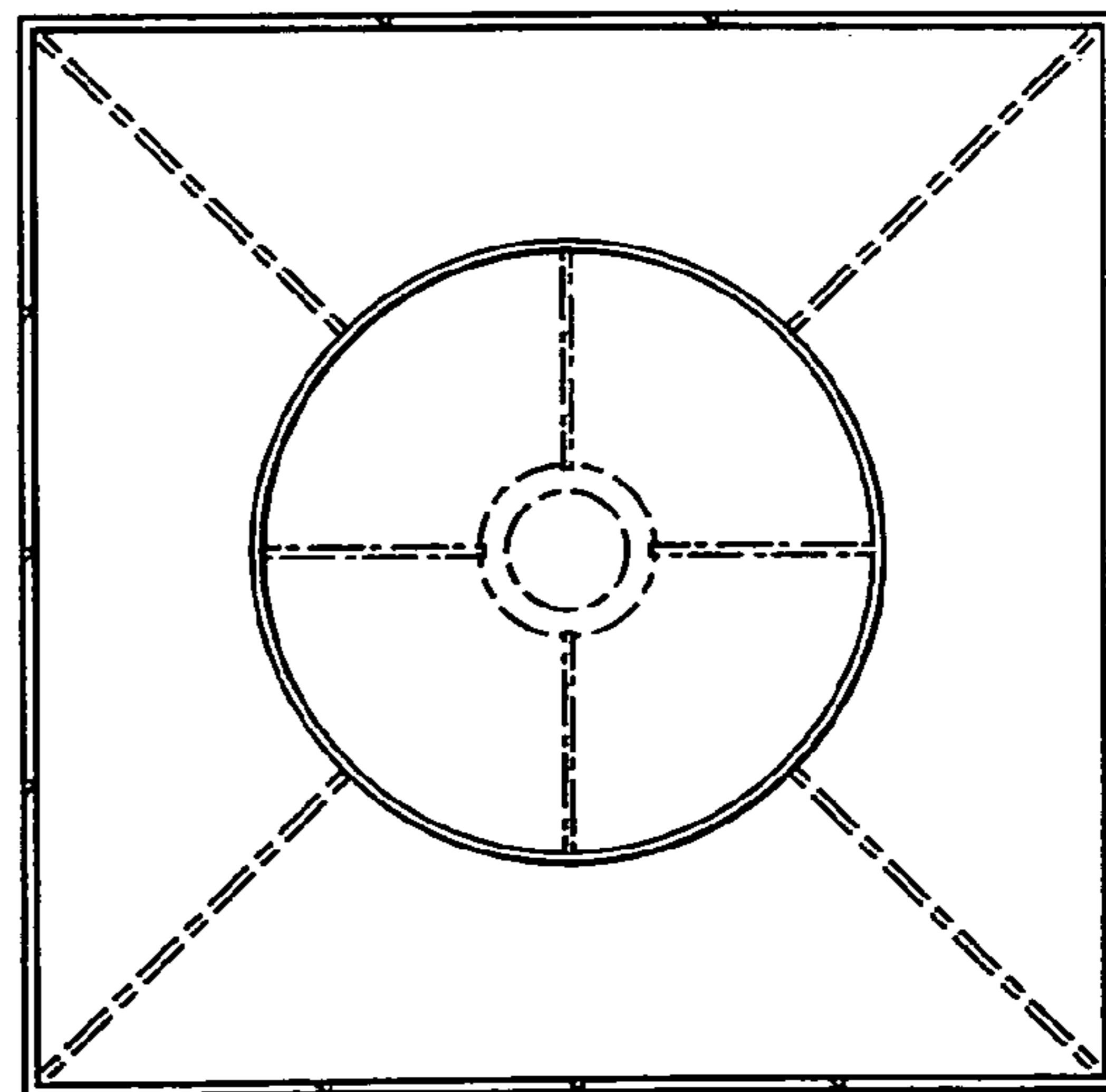

FIG. 18

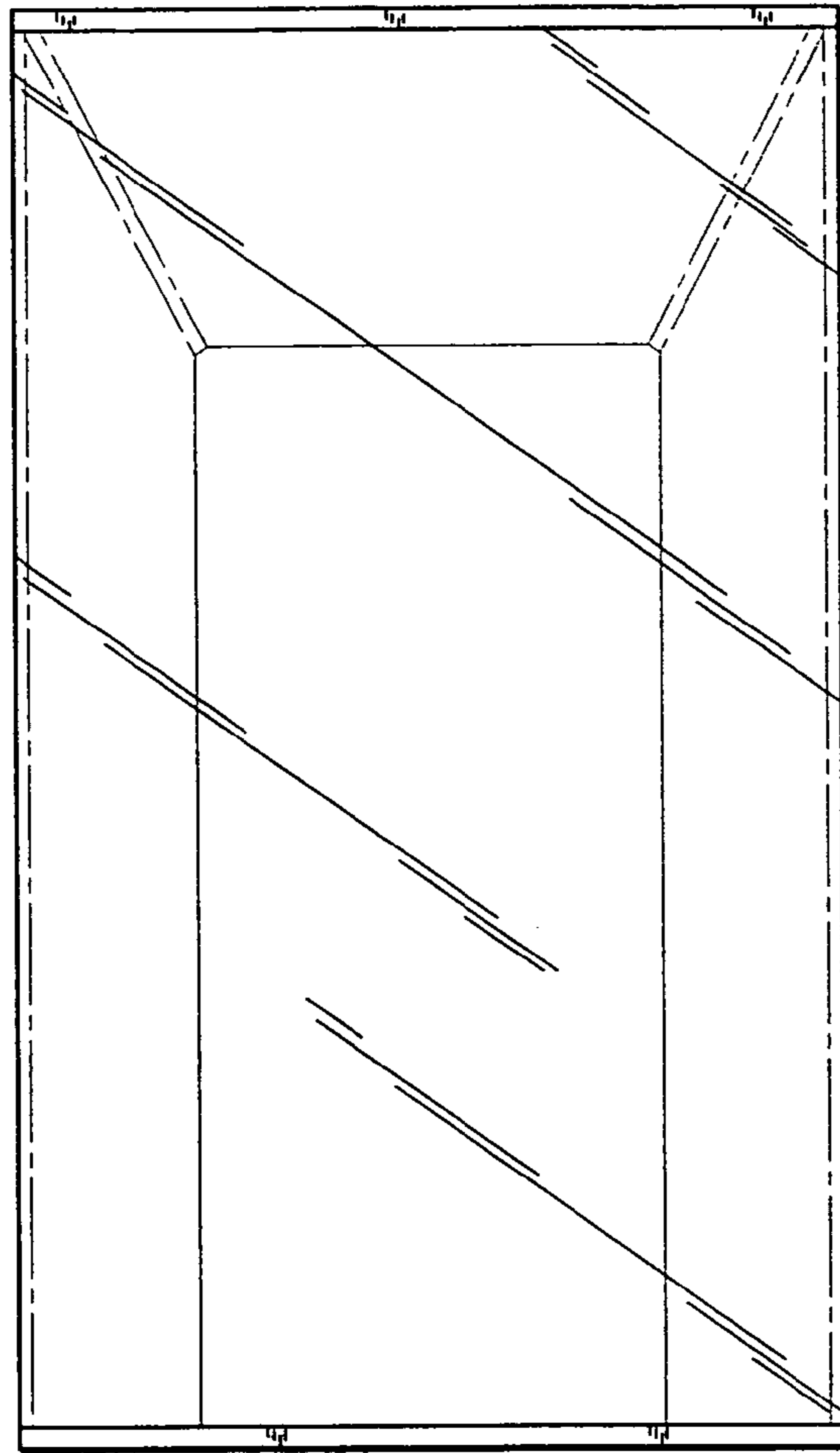

FIG. 19

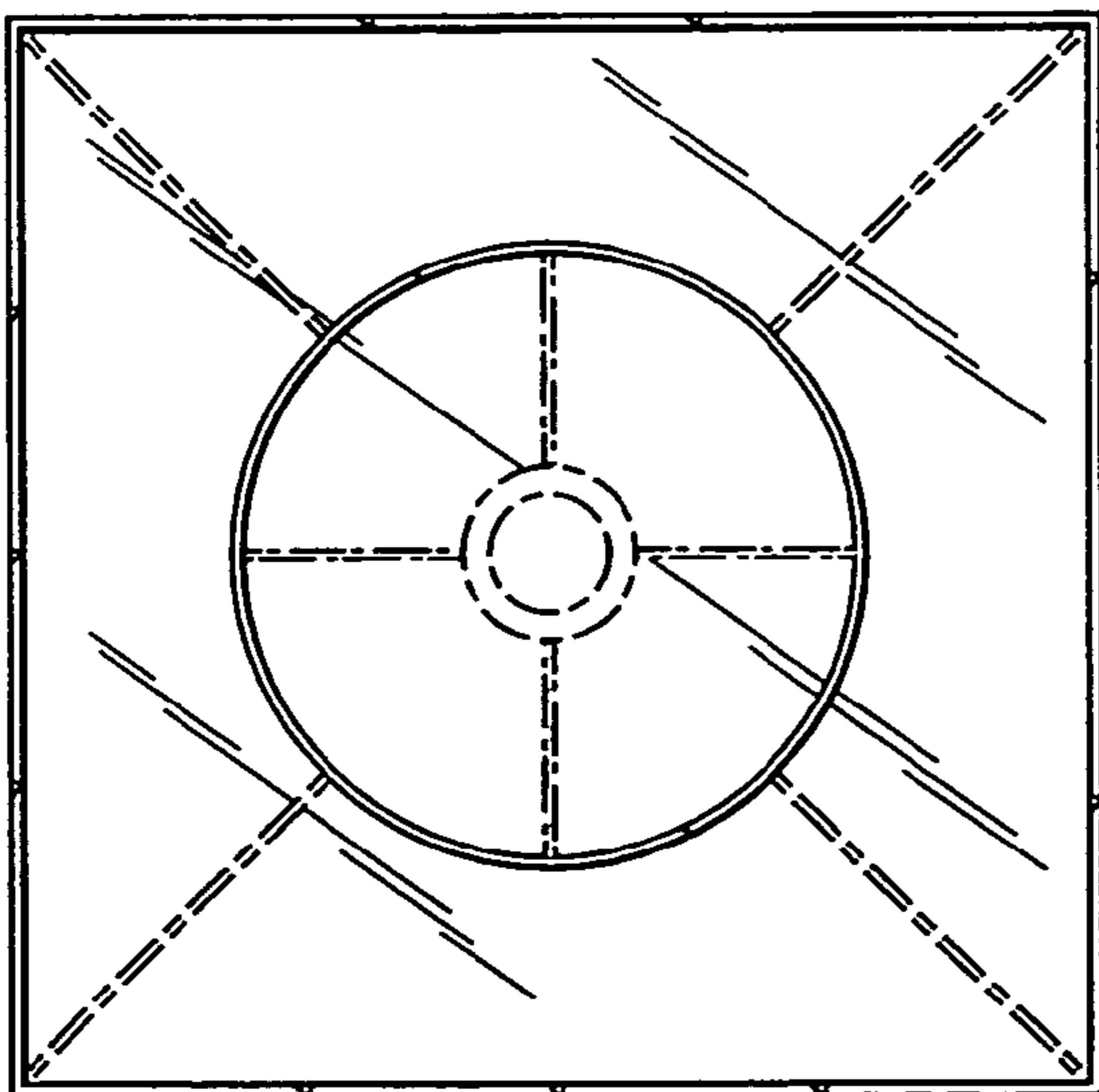

FIG. 20

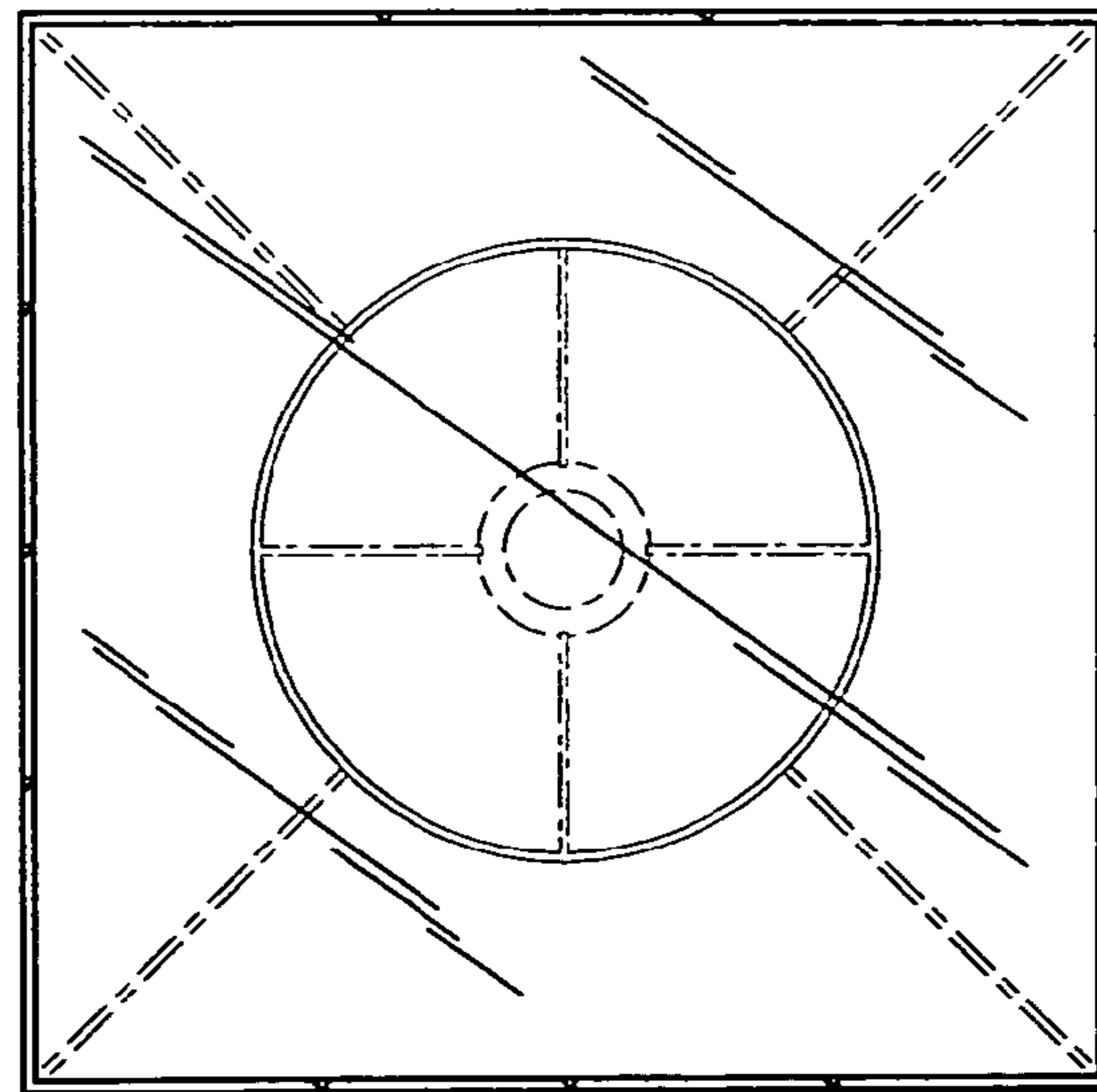

FIG. 21

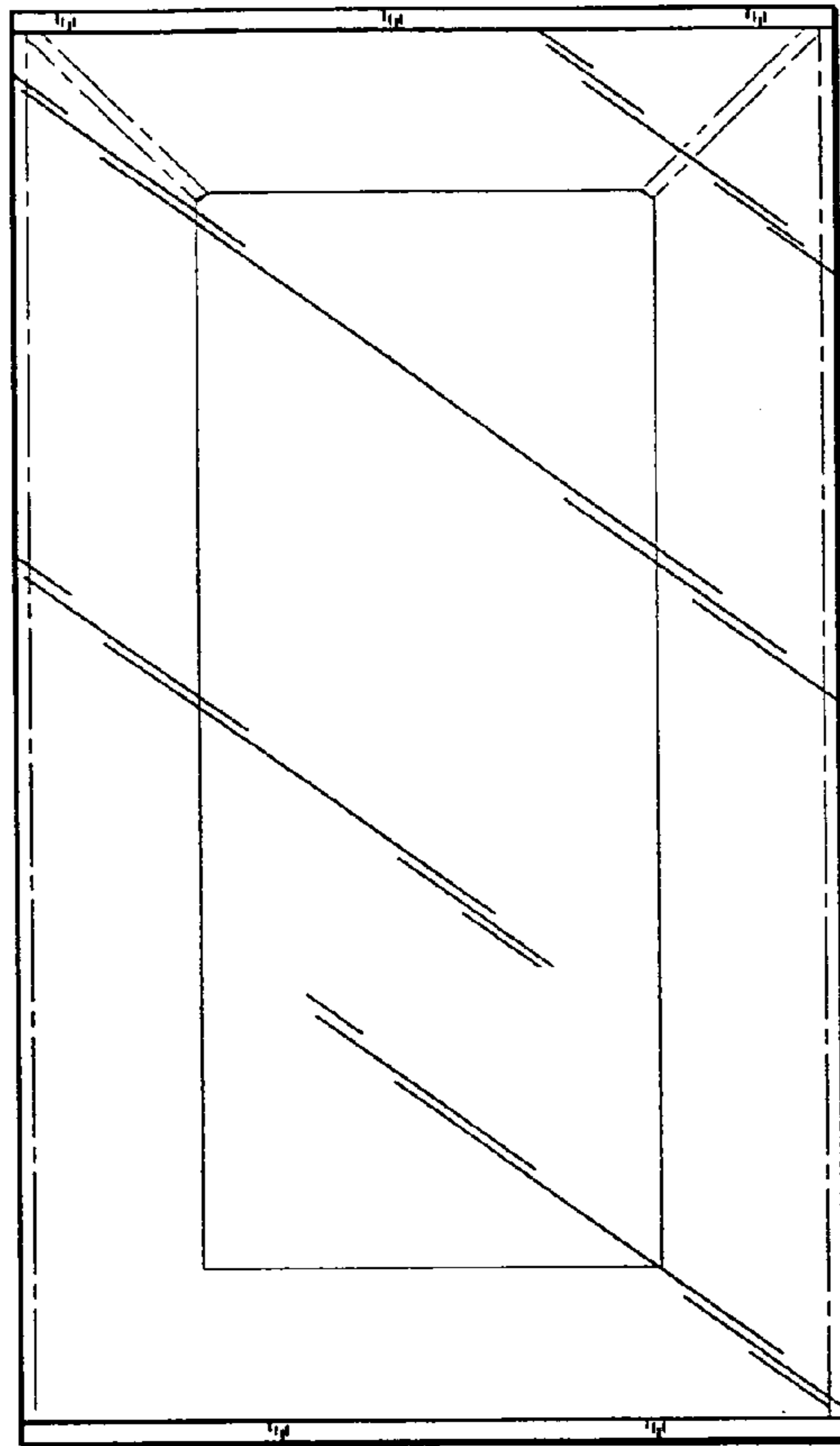

FIG. 22

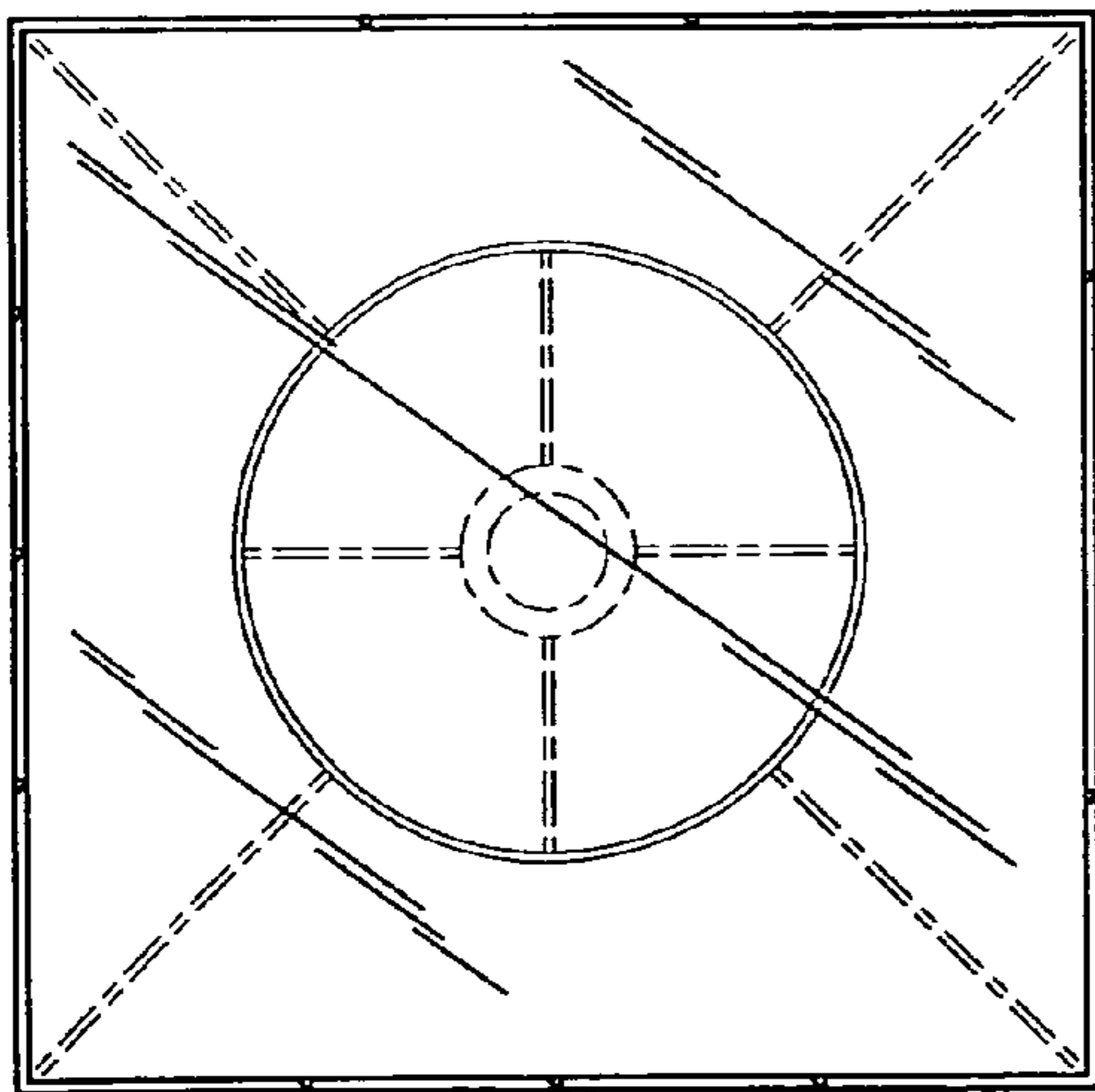

FIG. 23

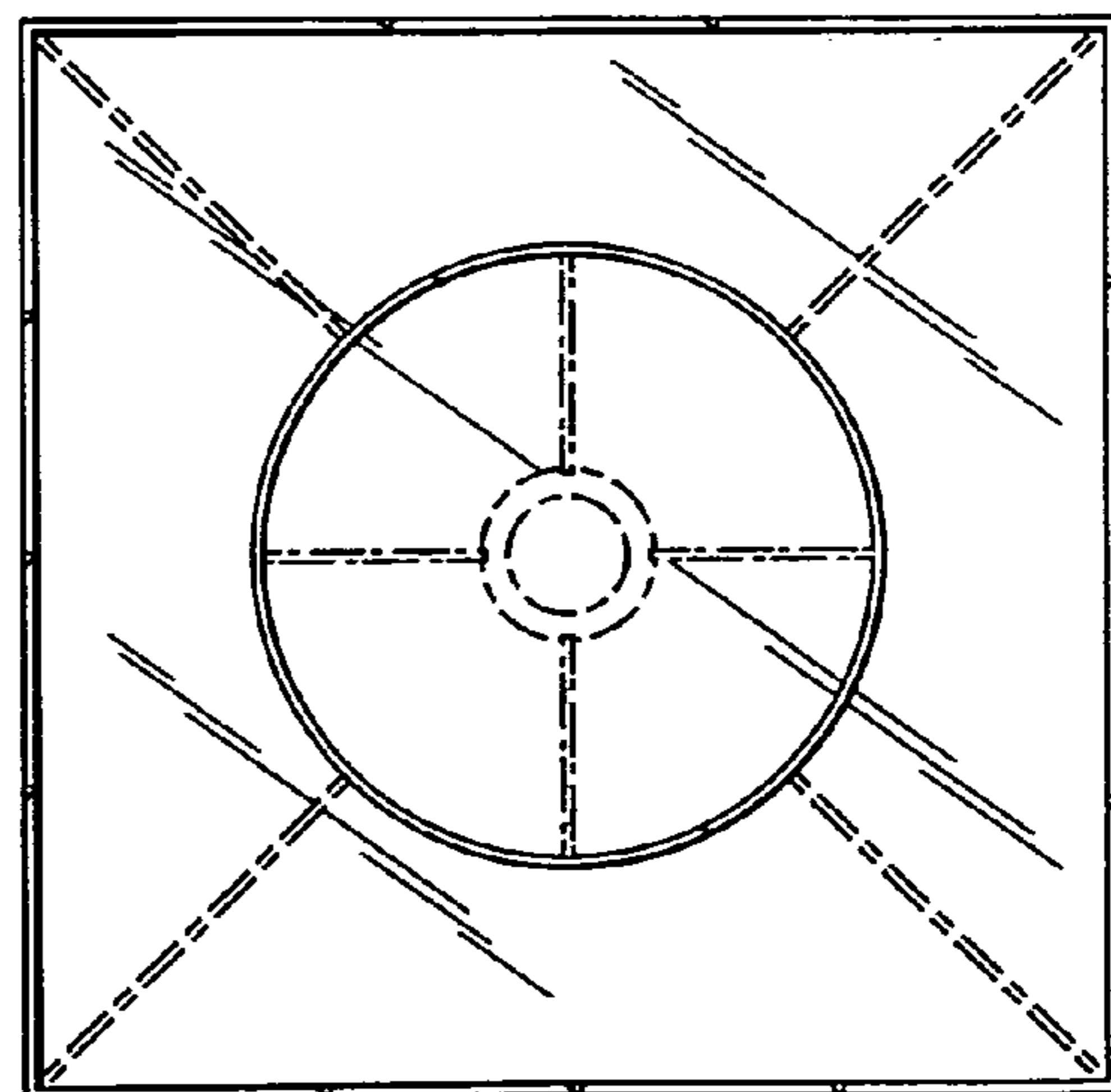

FIG. 24

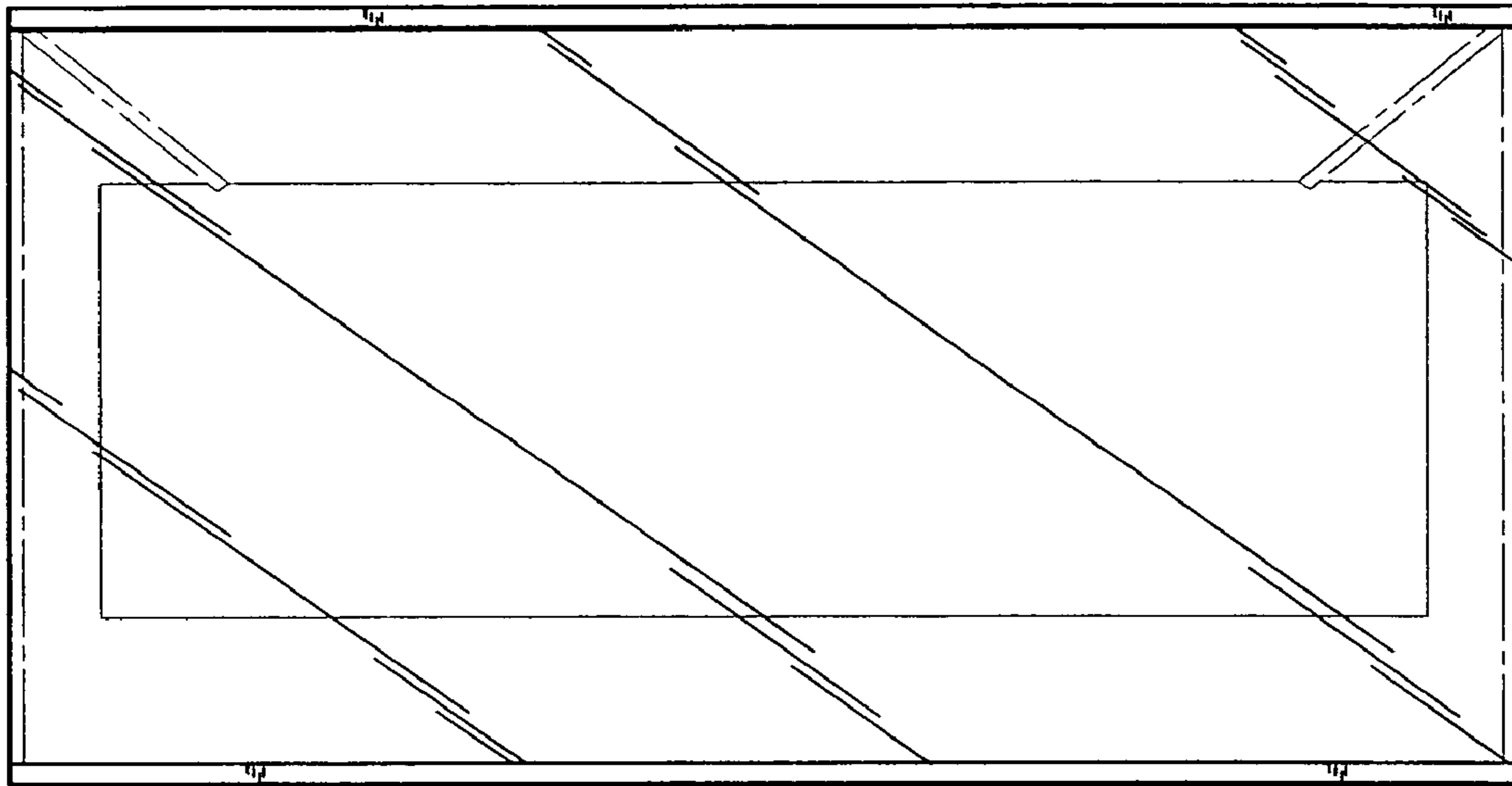

FIG. 25

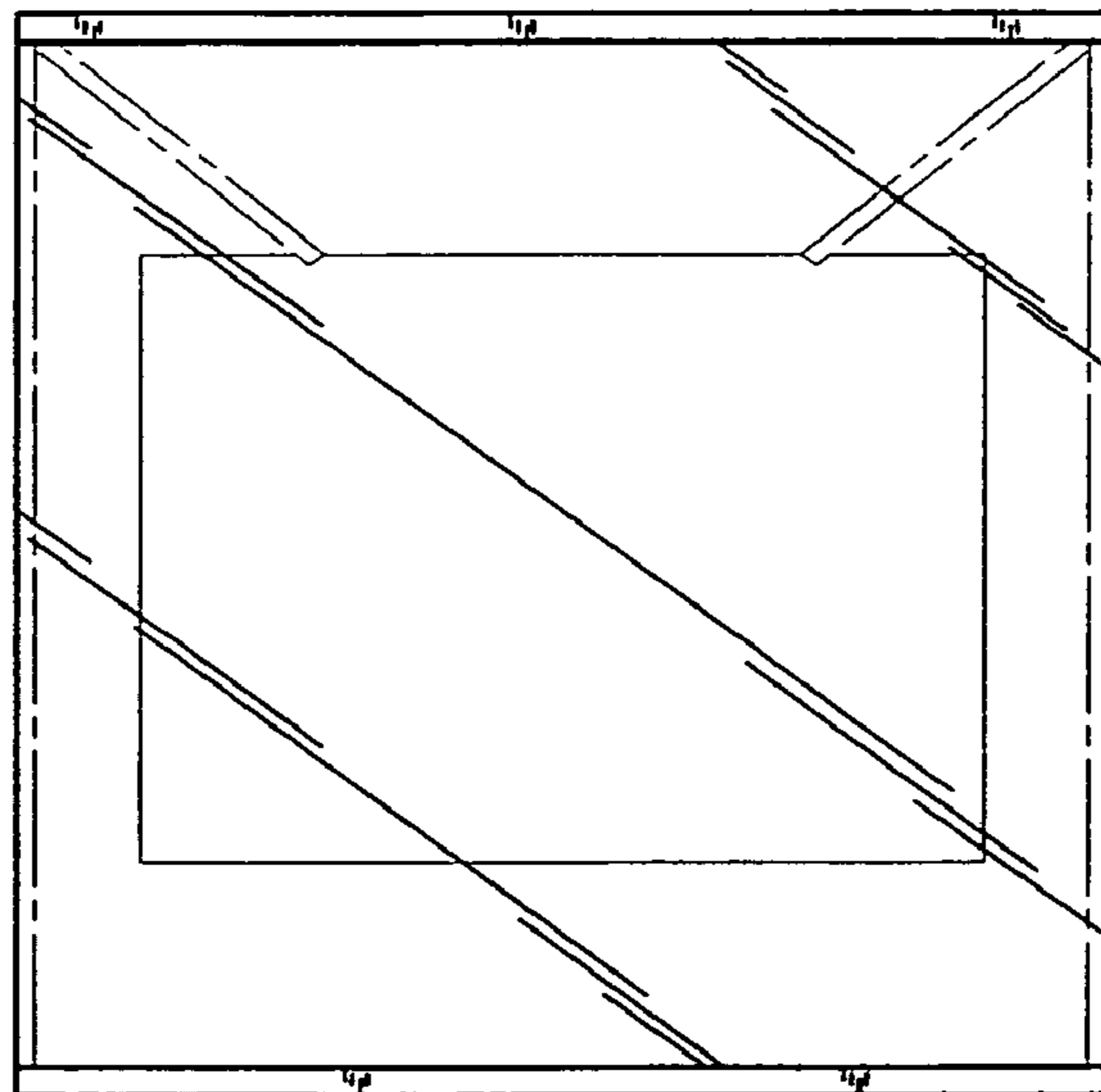

FIG. 26

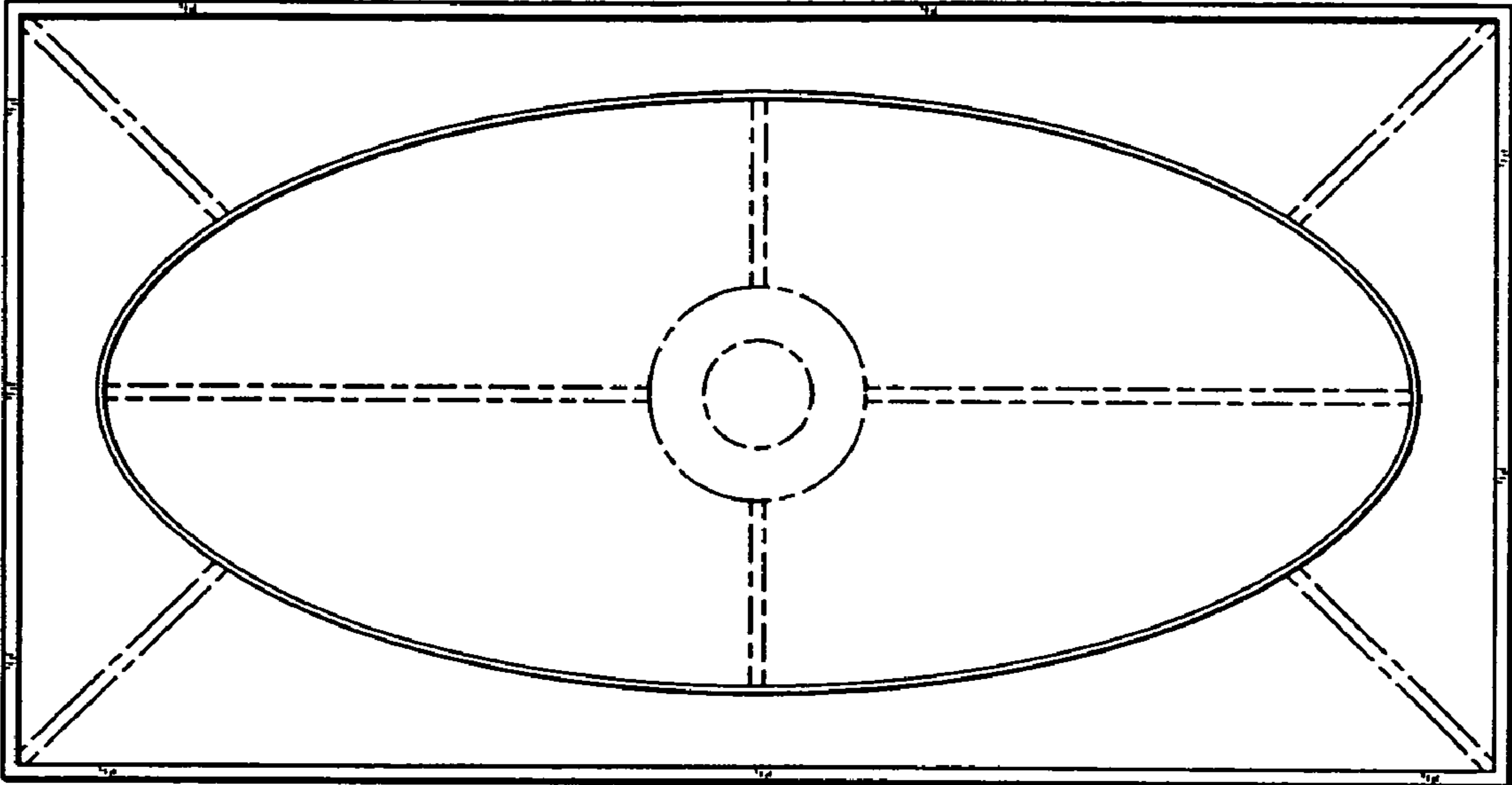

FIG. 27

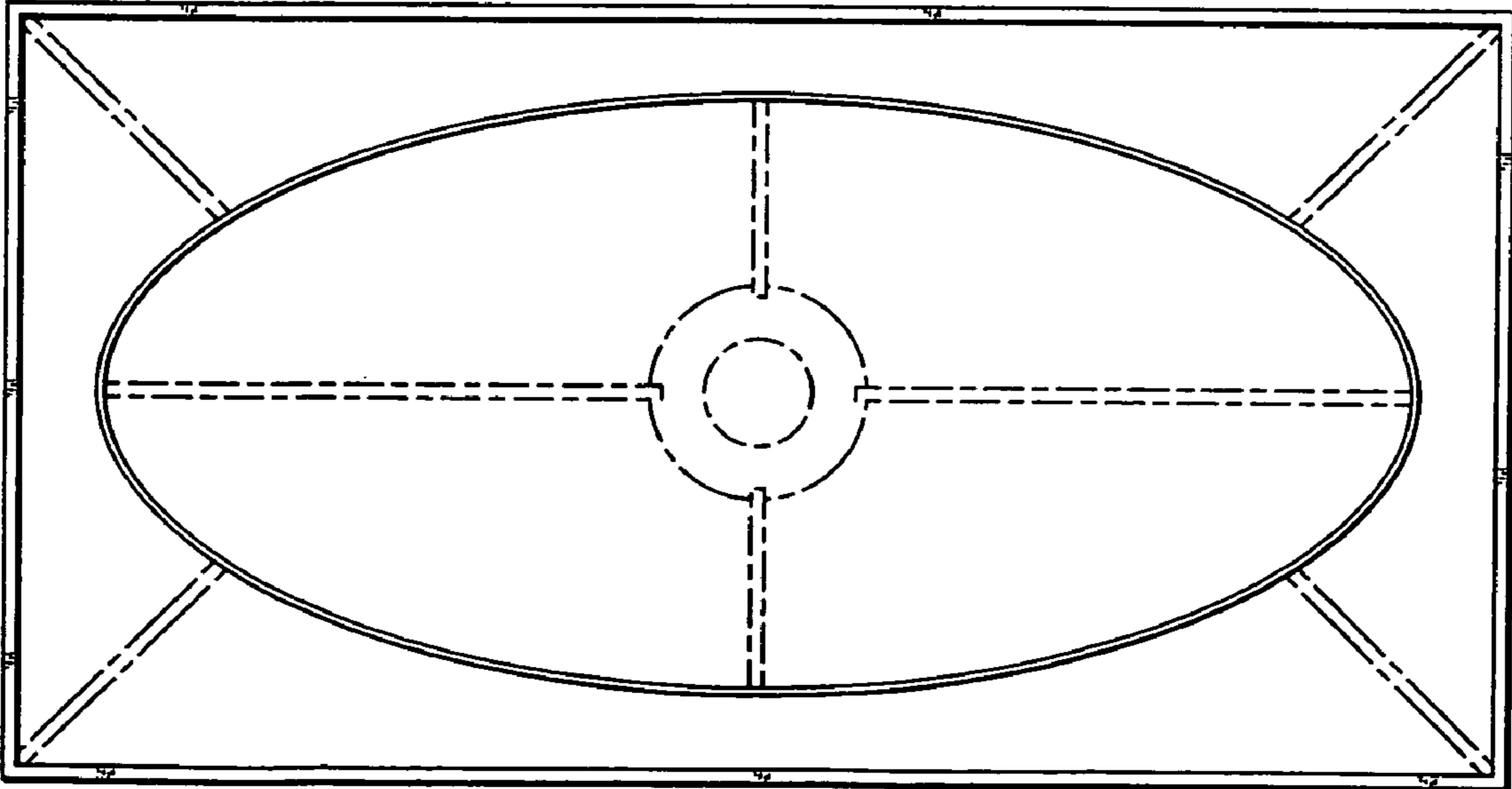

FIG. 28

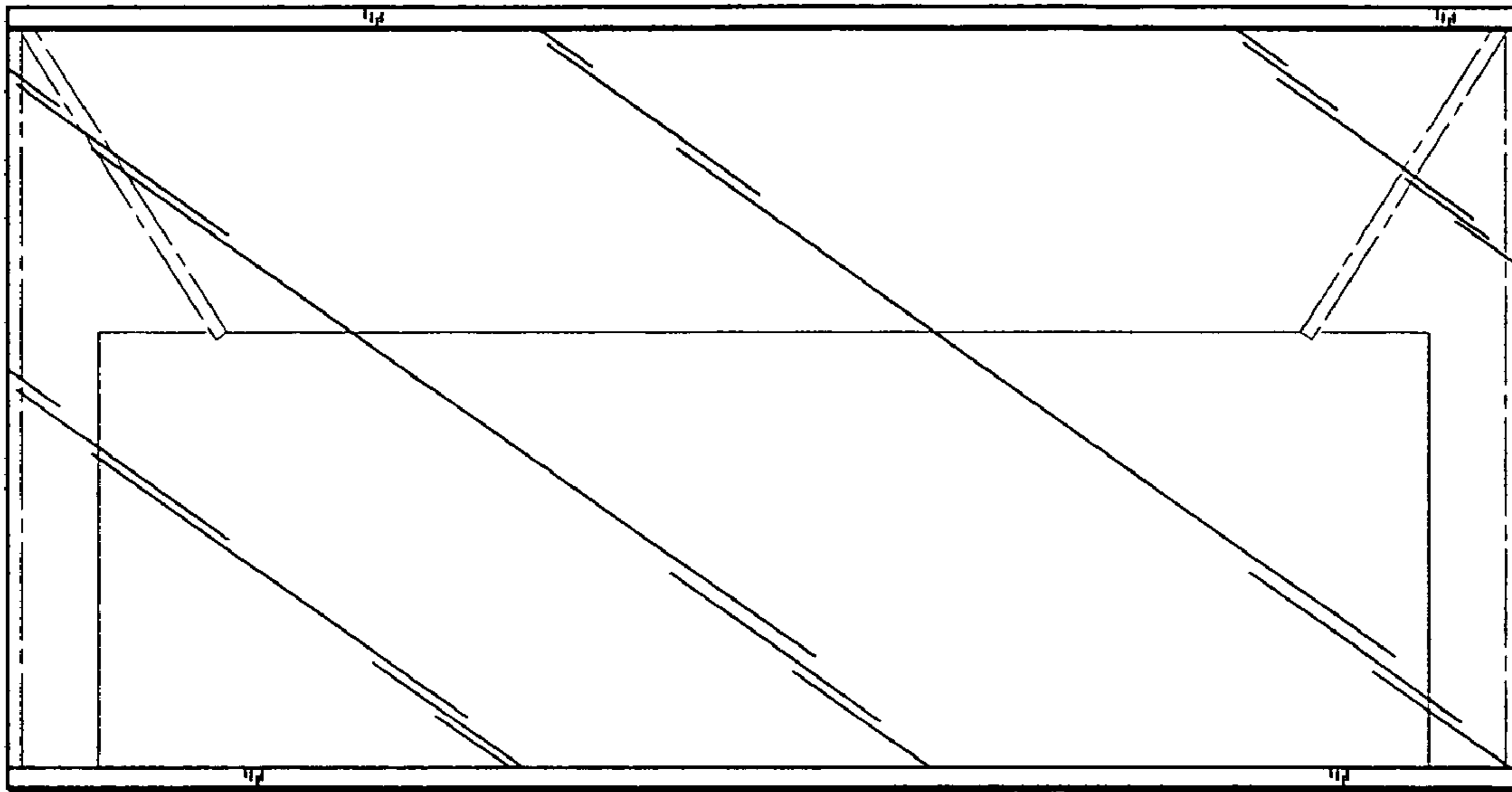

FIG. 29

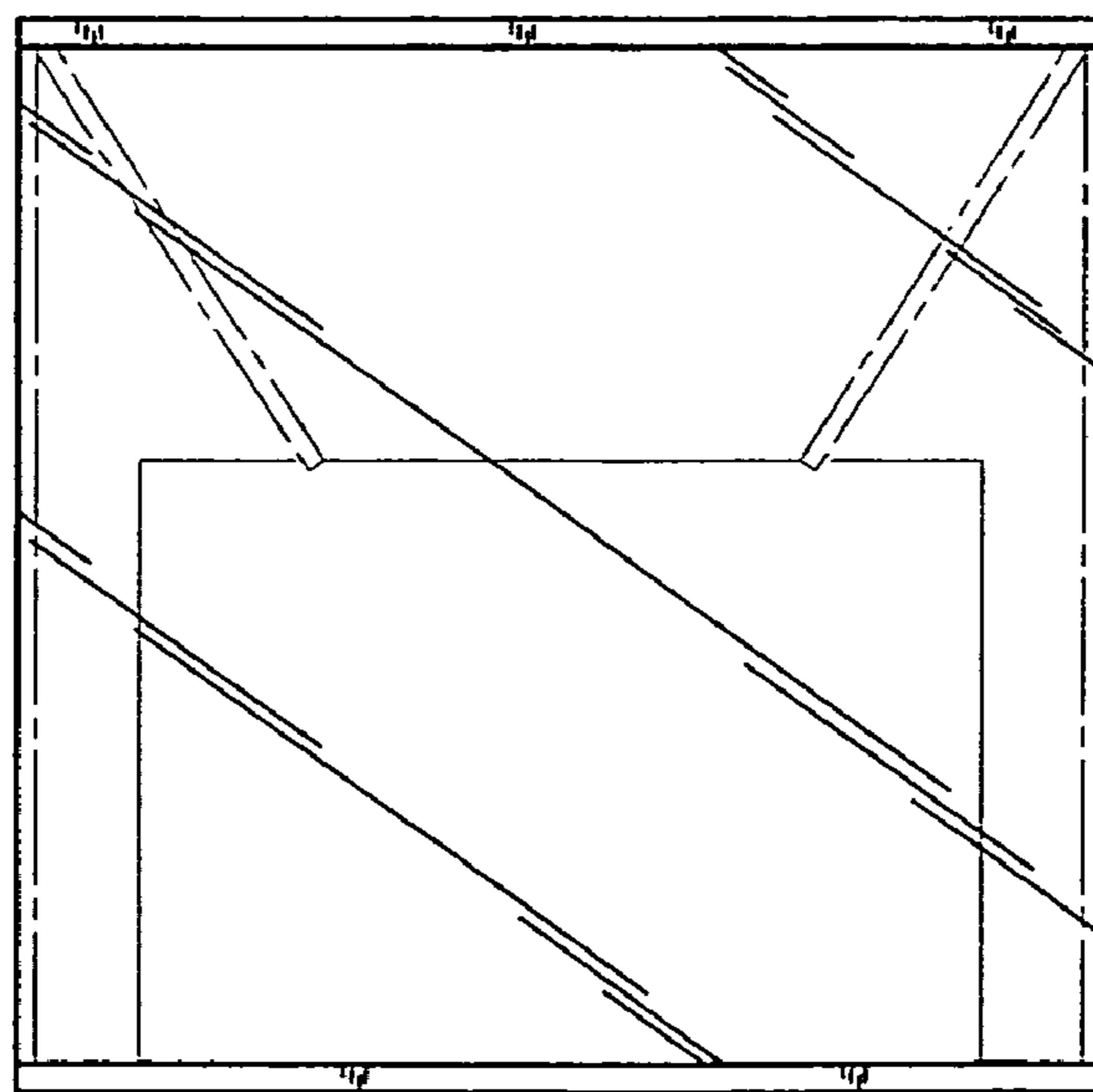

FIG. 30

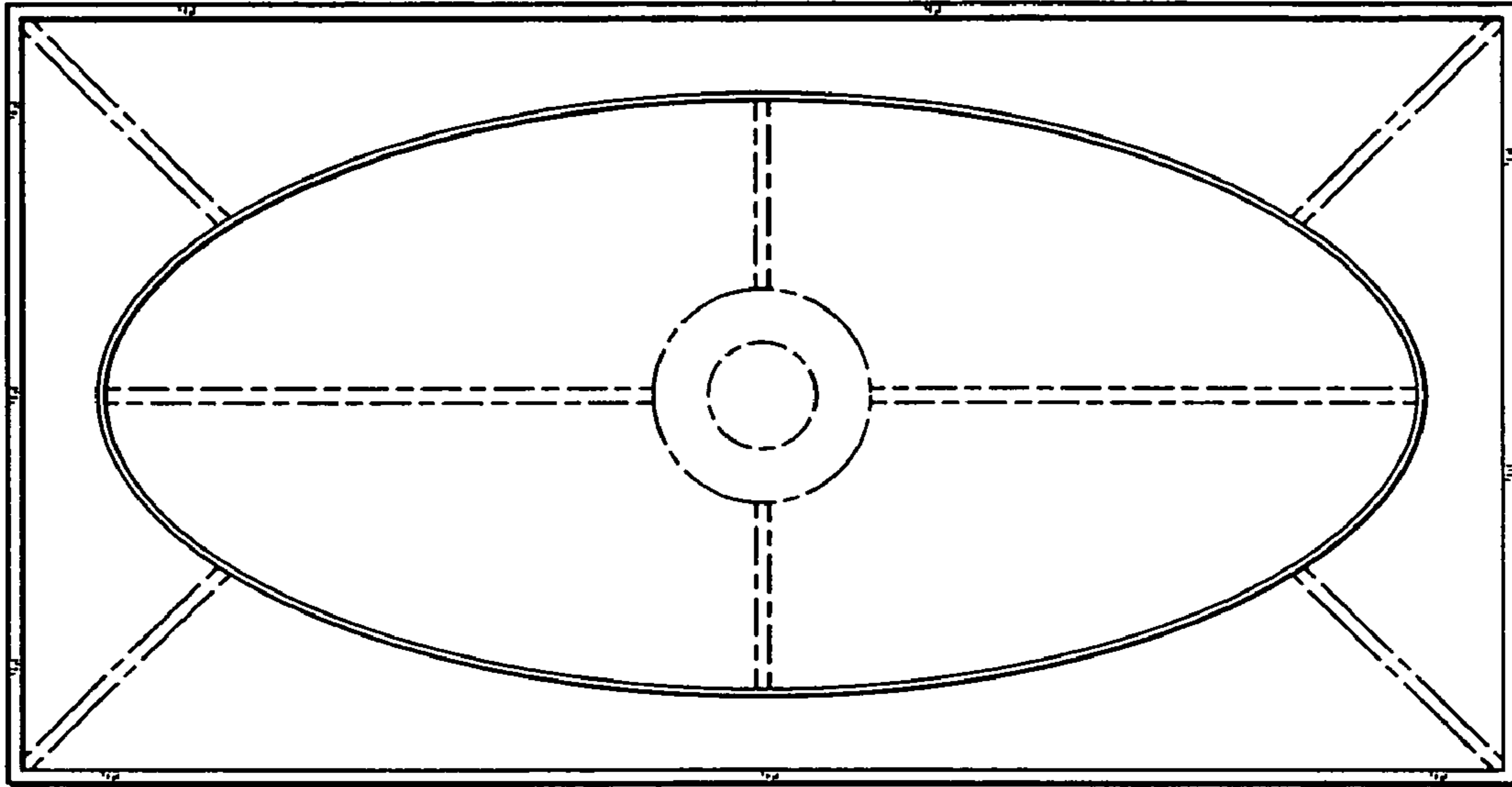

FIG. 31

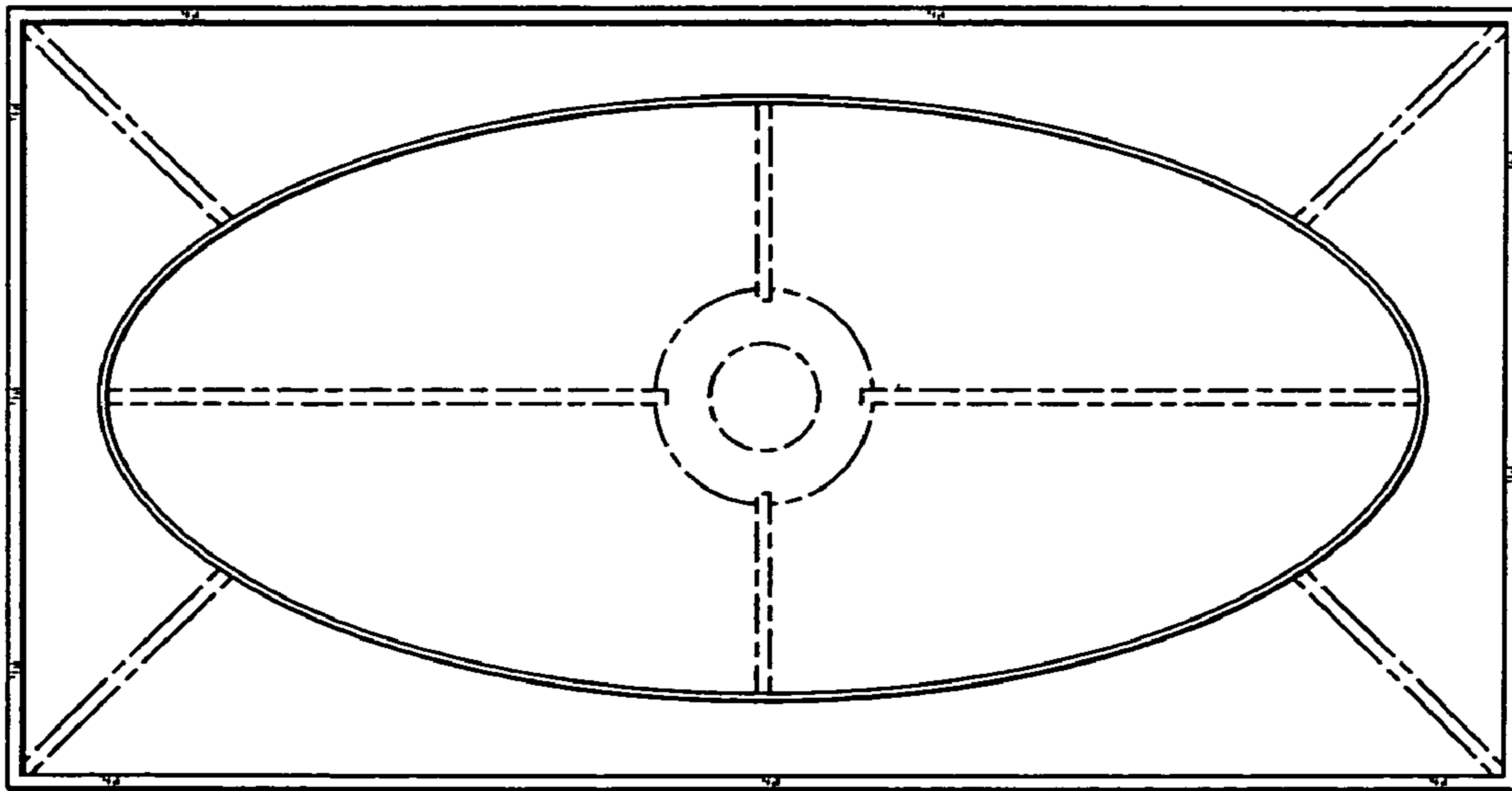

FIG. 32

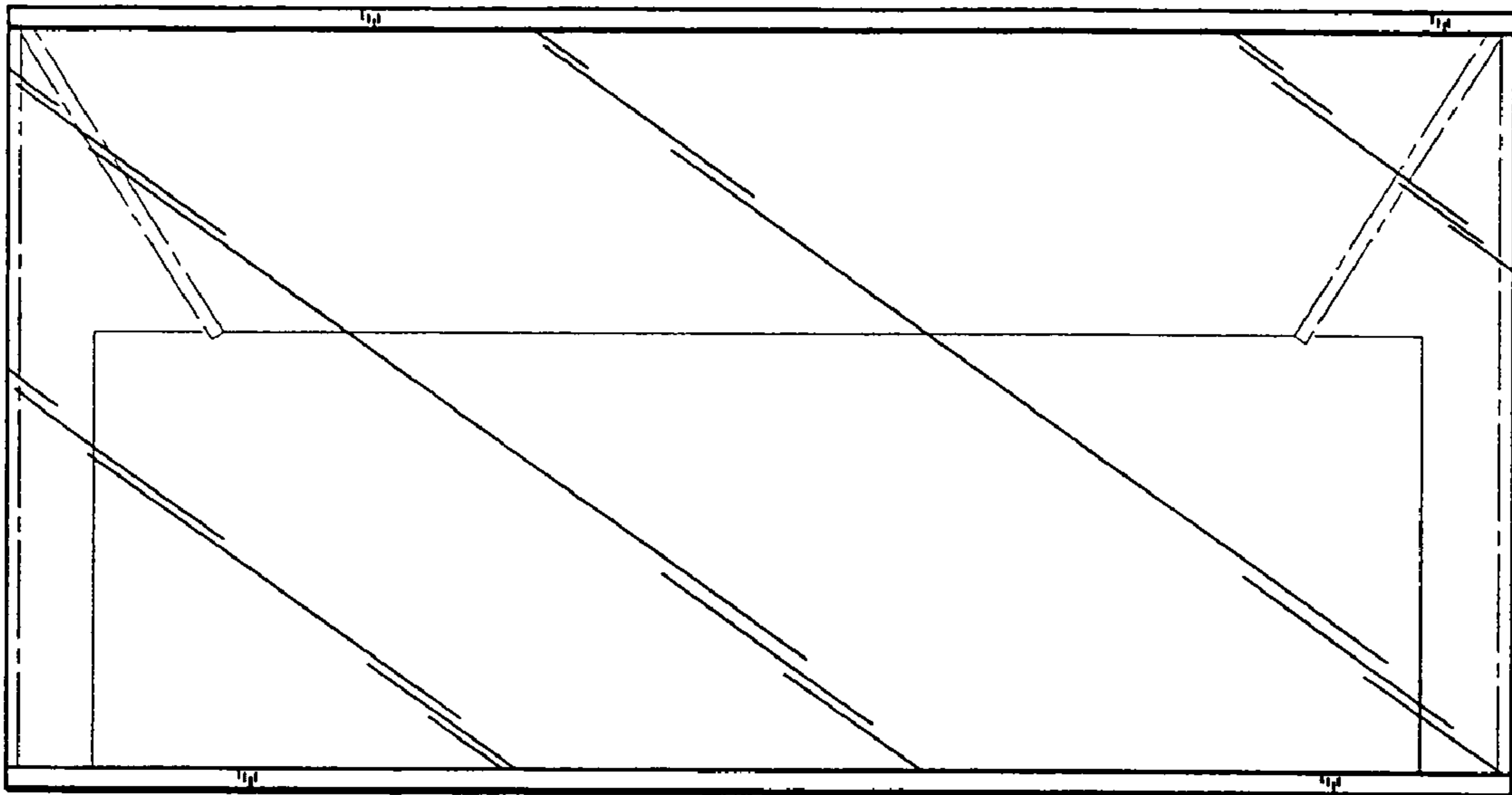

FIG. 33

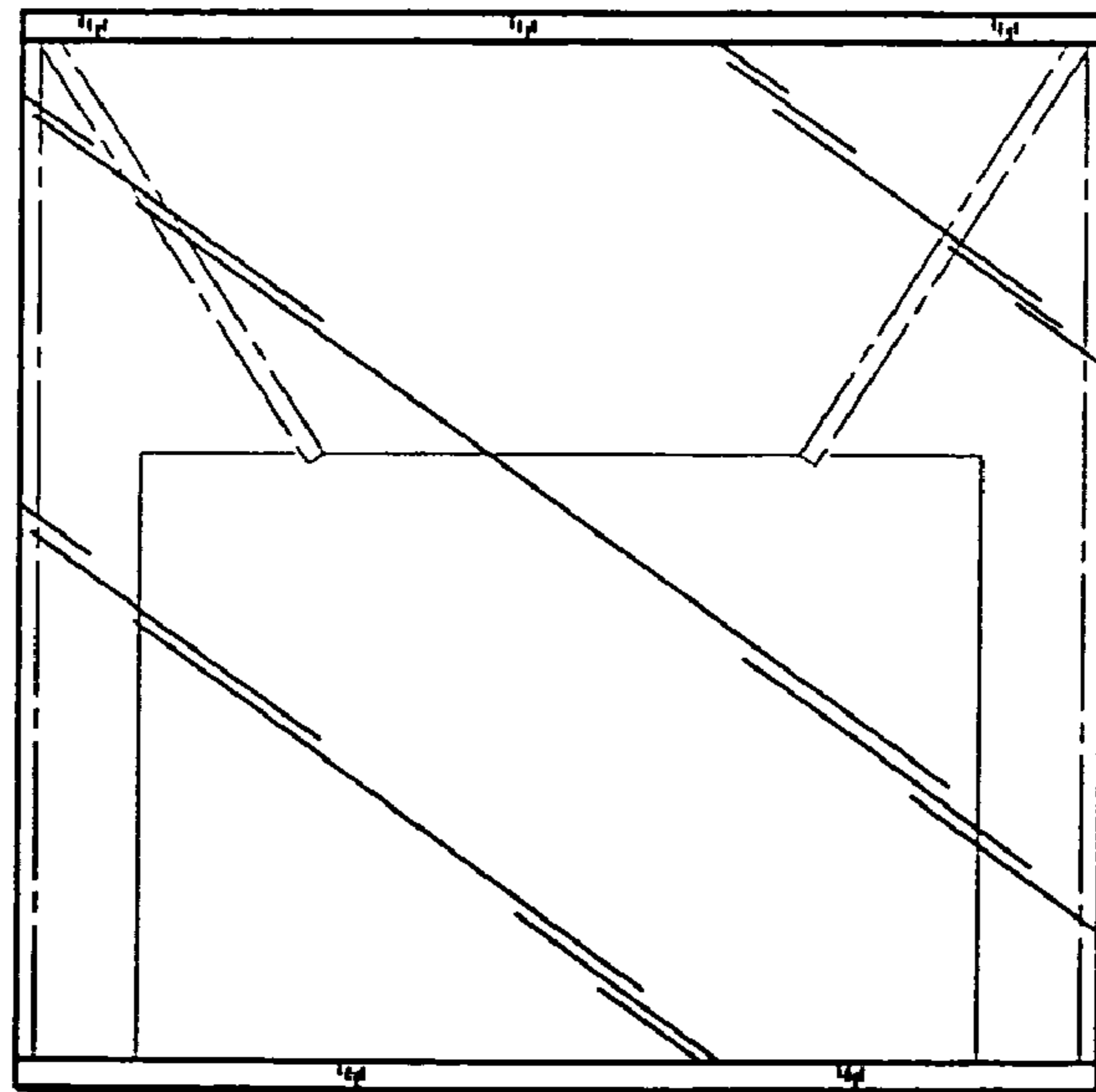

FIG. 34

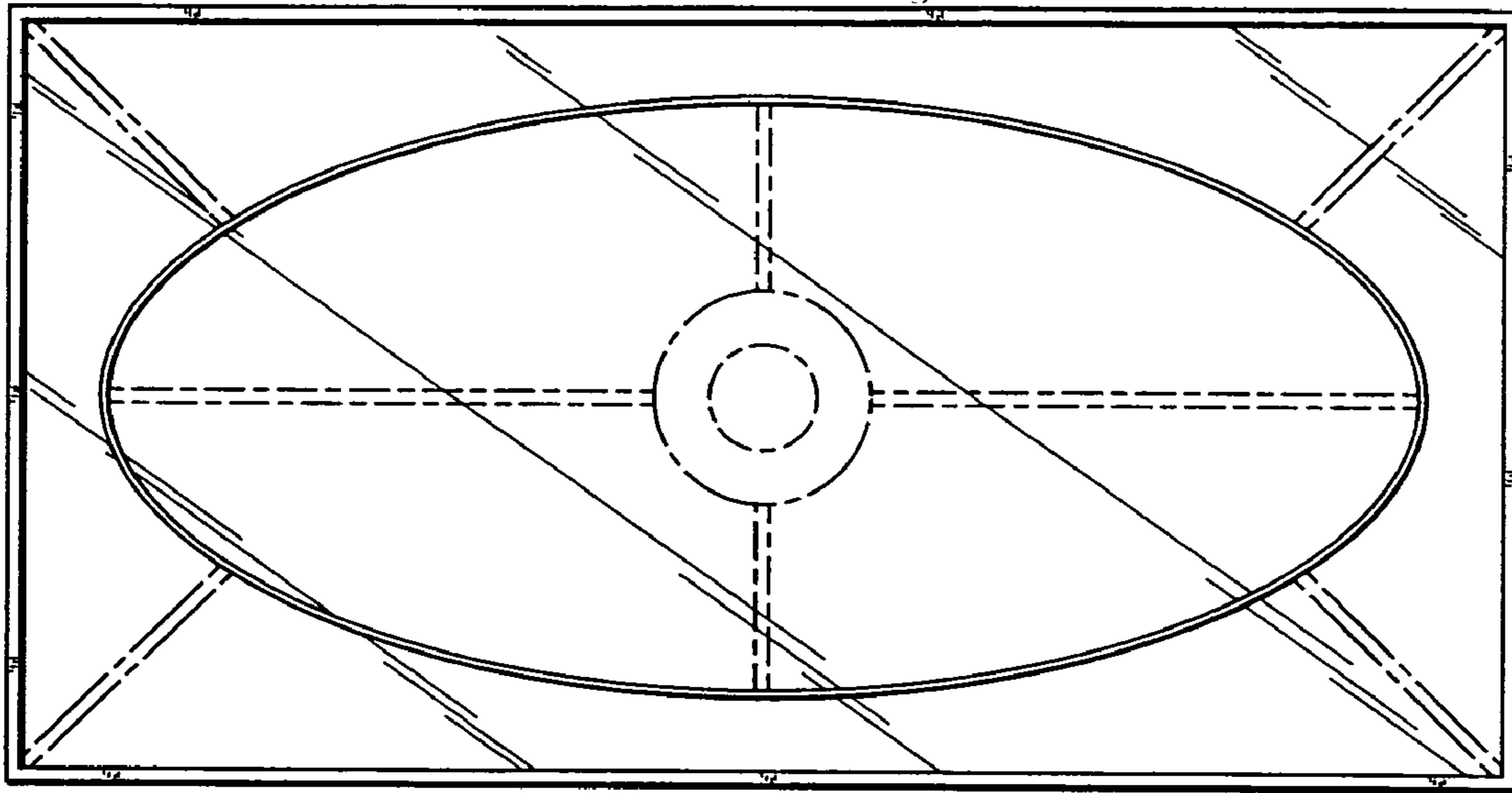

FIG. 35

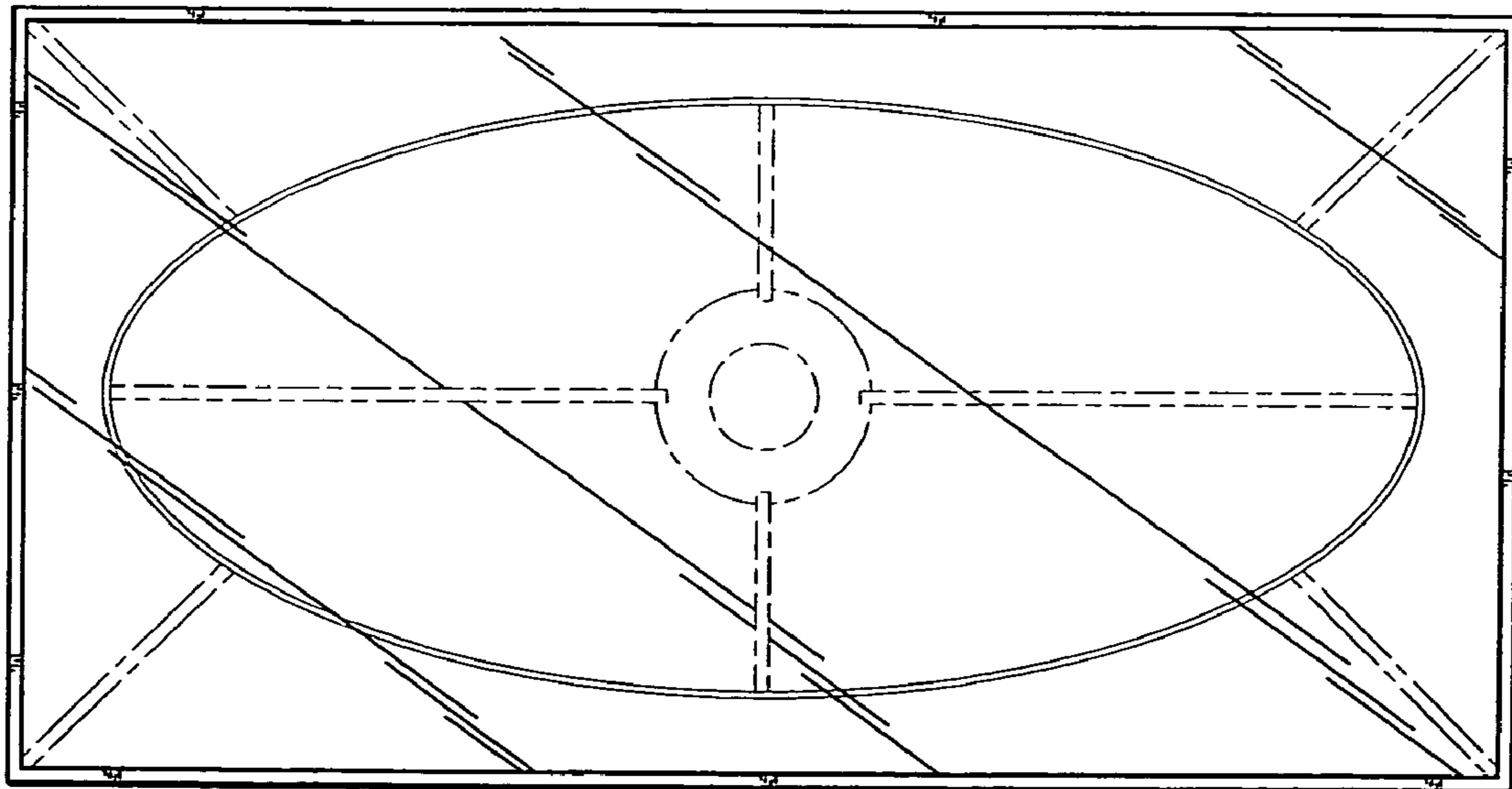

FIG. 36

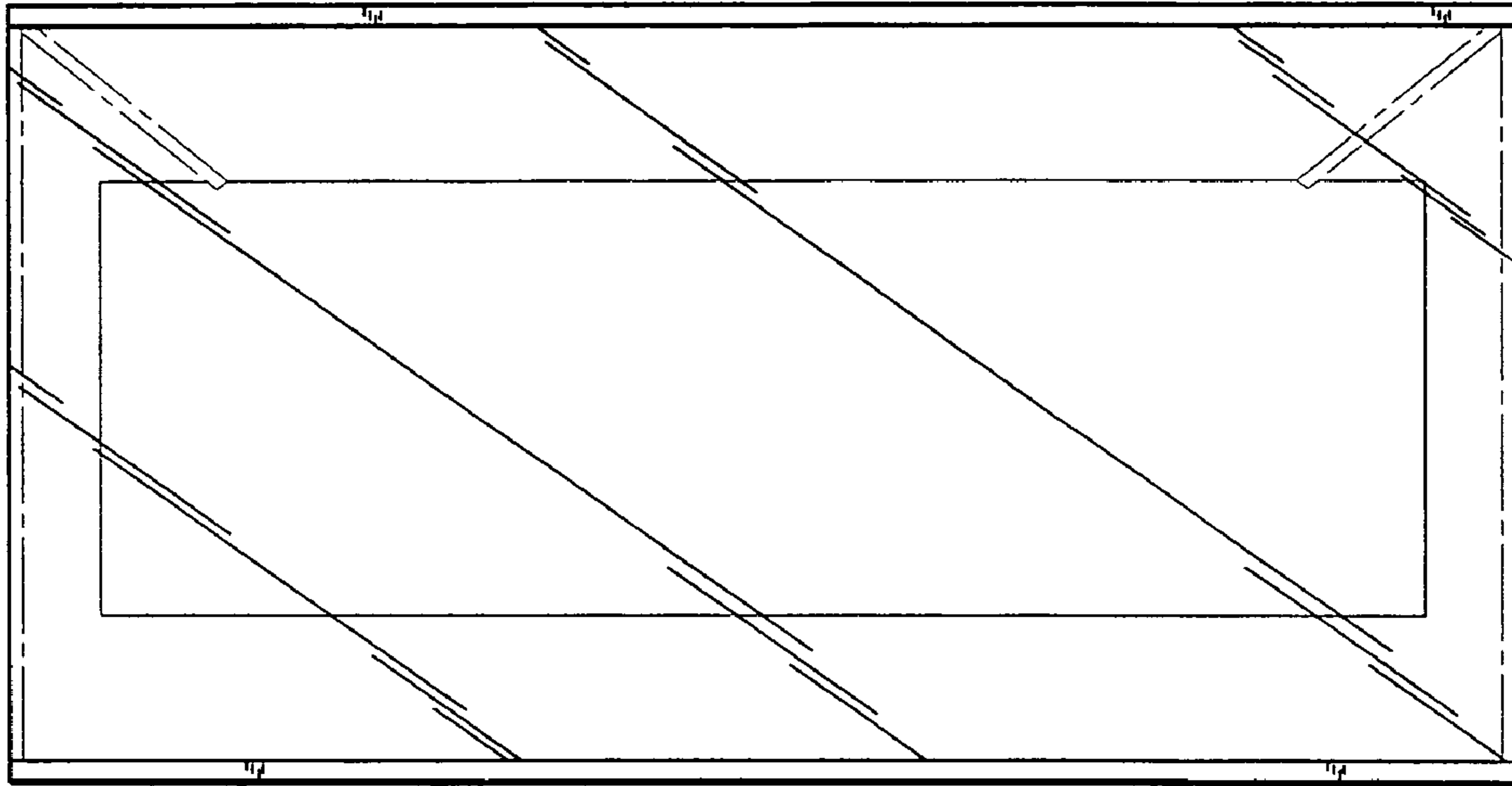

FIG. 37

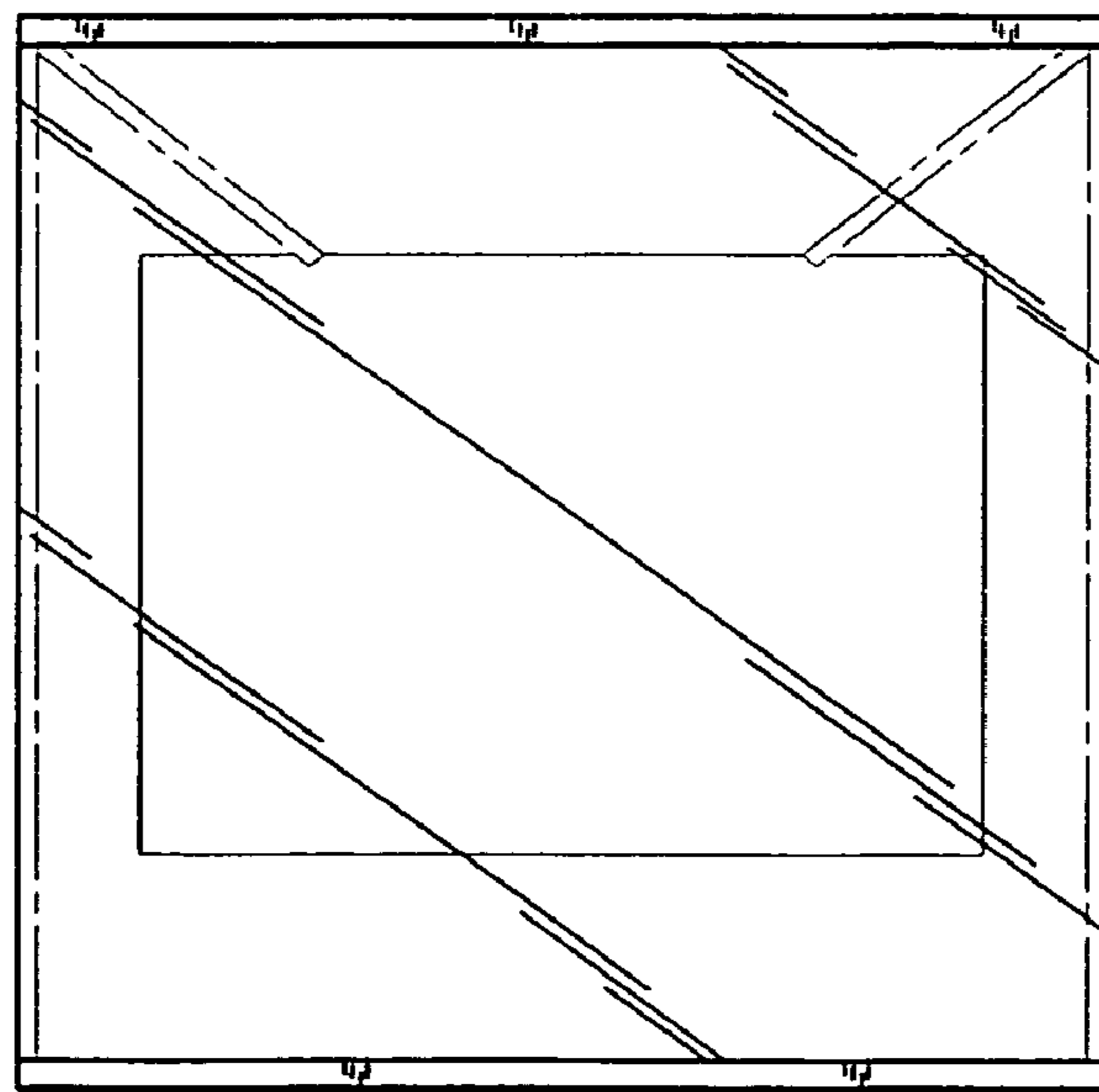

FIG. 38

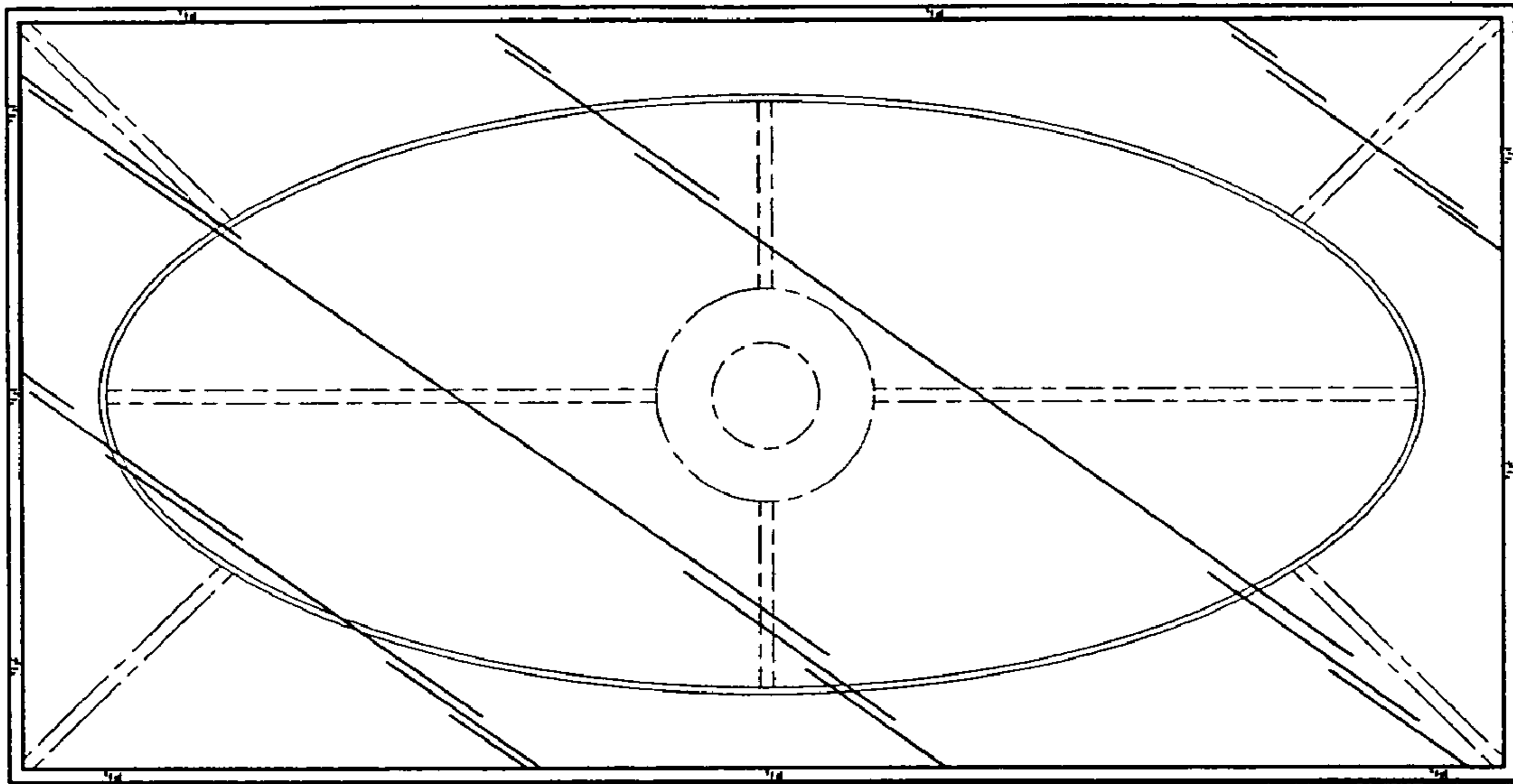

FIG. 39

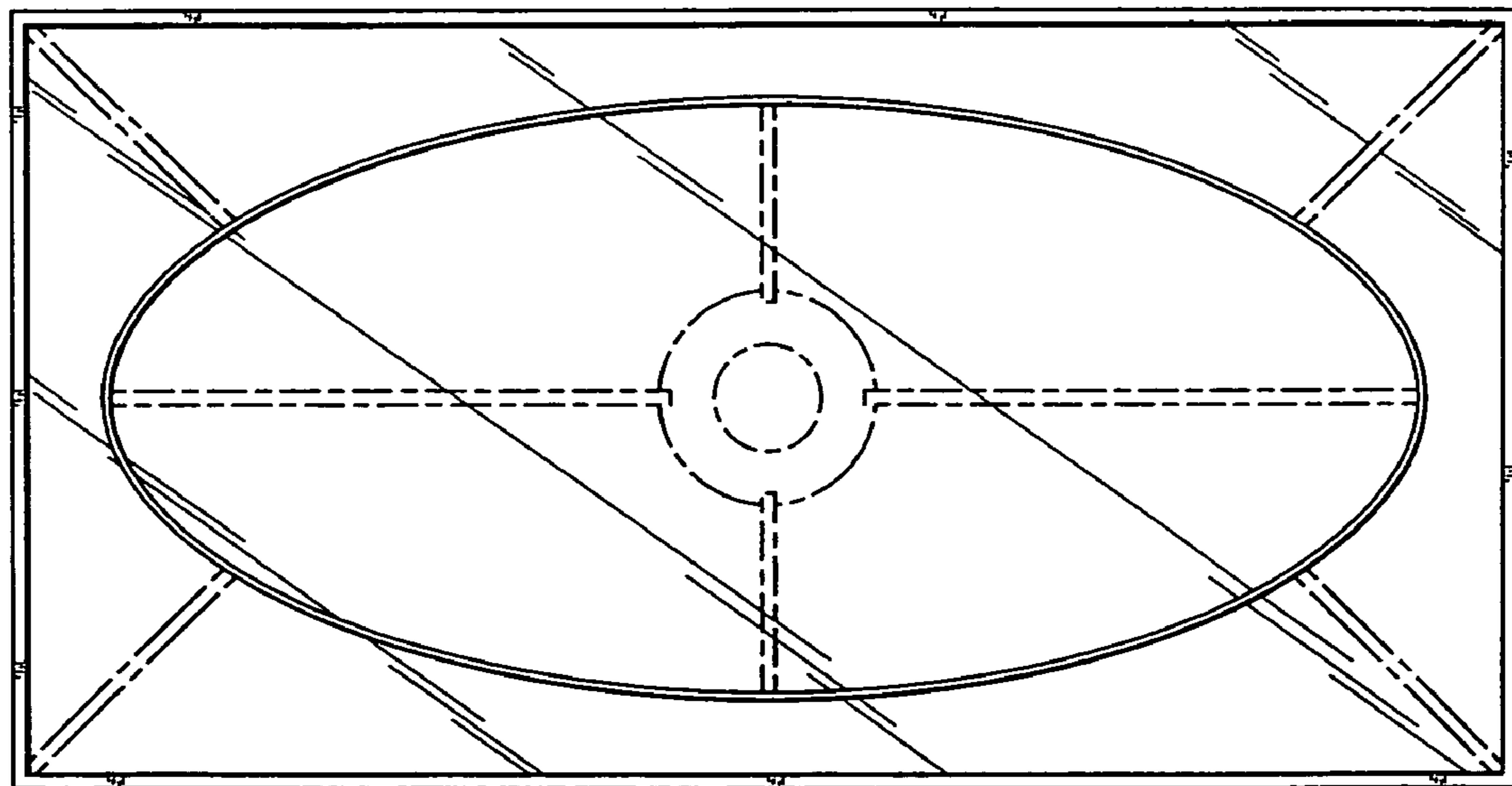

FIG. 40