



US00D548358S

(12) **United States Design Patent**
Koop

(10) **Patent No.:** **US D548,358 S**

(45) **Date of Patent:** **** Aug. 7, 2007**

(54) **PIPETTE**

(75) Inventor: **Norbert Koop**, Rellingen (DE)

(73) Assignee: **Eppendorf AG**, Hamburg (DE)

(**) Term: **14 Years**

(21) Appl. No.: **29/254,926**

(22) Filed: **Mar. 1, 2006**

(51) **LOC (8) Cl.** **24-02**

(52) **U.S. Cl.** **D24/222**

(58) **Field of Classification Search** D24/121,
D24/222, 227; 73/864.01, 864.11-12, 864.14-16,
73/864.23-24, 864.33-35, 863.83; 141/25-27;
222/32; 422/100, 919, 922-926, 928-929
See application file for complete search history.

(56) **References Cited**

U.S. PATENT DOCUMENTS

3,805,998	A *	4/1974	Croslin	222/32
3,991,617	A *	11/1976	Marteau d'Autry	73/864.14
D252,823	S *	9/1979	Withers et al.	D24/222
4,567,780	A *	2/1986	Oppenlander et al.	...	73/864.16
5,018,394	A *	5/1991	Gilson	73/864.18
D375,798	S *	11/1996	Boothby	D24/222
5,983,733	A *	11/1999	Strandberg et al.	73/864.11
D419,685	S *	1/2000	Jacquet et al.	D24/222
D426,642	S *	6/2000	Rainin et al.	D24/222
D426,643	S *	6/2000	Rainin et al.	D24/222
D438,630	S *	3/2001	Honore	D24/222

OTHER PUBLICATIONS

Brochure: Produkte und Applikationen fur das Labor 2006 , (cover page, pp. 58-59, back page), Statement of Relevancy Attached.

* cited by examiner

Primary Examiner—Louis Zarfes

Assistant Examiner—Mark Cavanna

(74) *Attorney, Agent, or Firm*—Vidas, Arrett & Steinkraus, P.A.

(57) **CLAIM**

The ornamental design for pipette, as shown and described.

DESCRIPTION

FIG. 1 is a front view of the first embodiment of a pipette, showing my new design;

FIG. 2 is a left side view thereof;

FIG. 3 is a right side view thereof;

FIG. 4 is a rear view thereof;

FIG. 5 is a top view thereof;

FIG. 6 is a bottom view thereof;

FIG. 7 is a perspective view thereof;

FIG. 8 is a front of the second embodiment view thereof;

FIG. 9 is a left side thereof;

FIG. 10 is a right side thereof;

FIG. 11 is a rear side thereof;

FIG. 12 is a top view thereof;

FIG. 13 is a bottom thereof; and,

FIG. 14 is a perspective thereof.

The broken line showing of pipette tip is included for the purpose of illustration and forms no part of the claimed design.

1 Claim, 14 Drawing Sheets

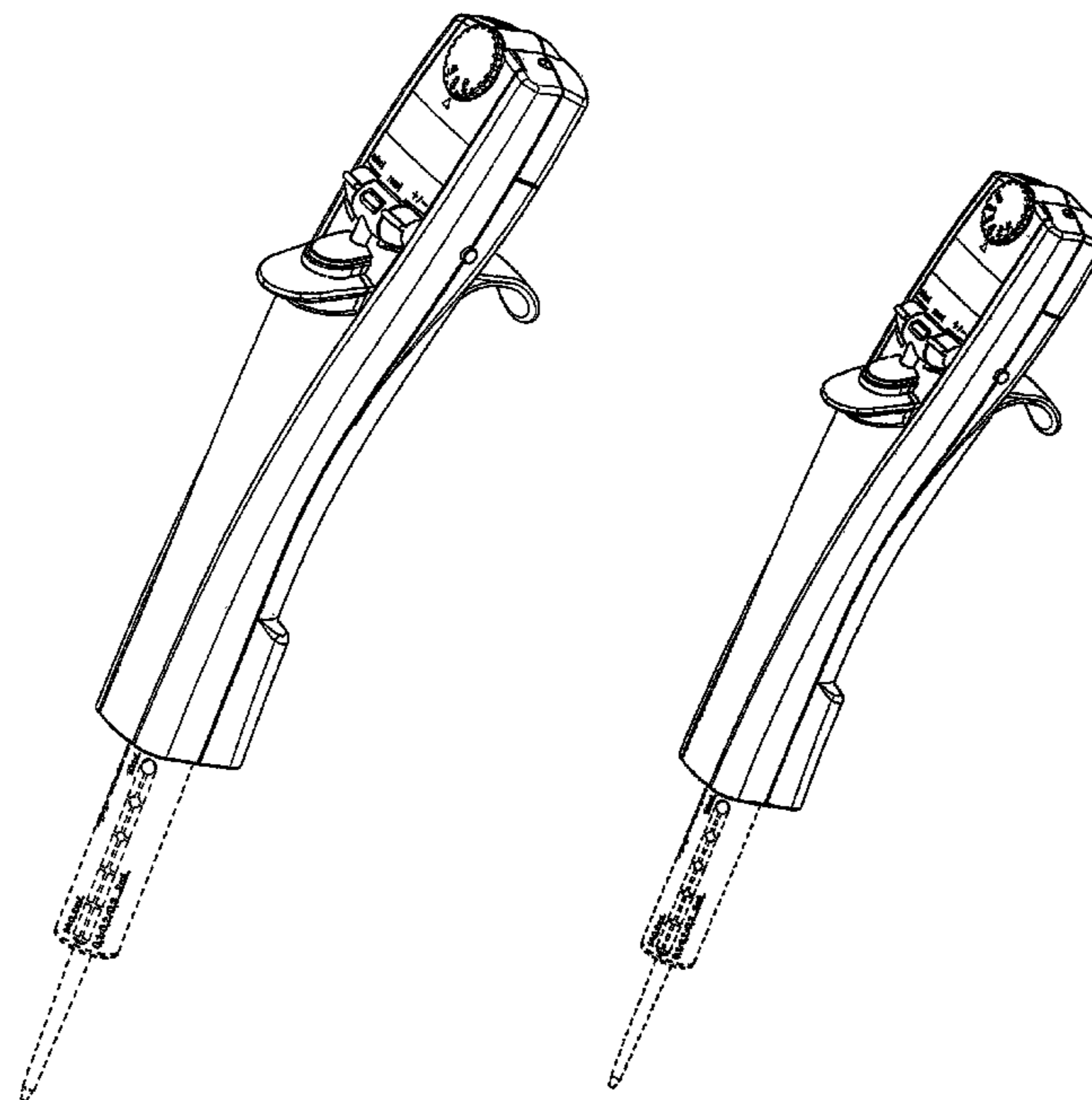

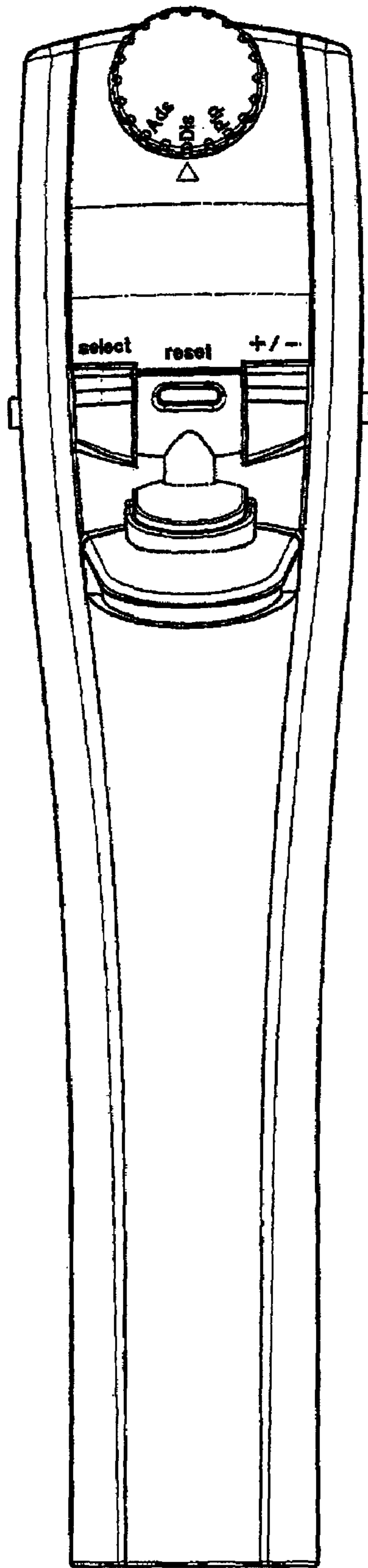

Fig. 1

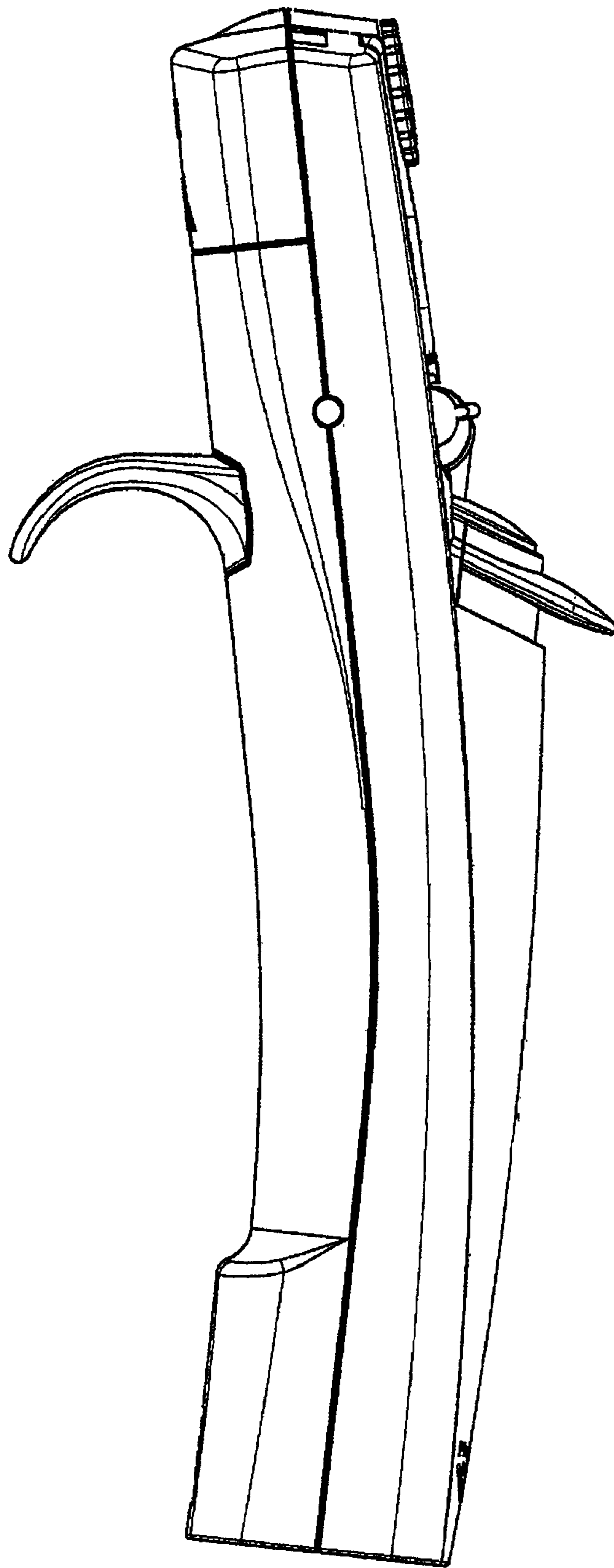

Fig. 2

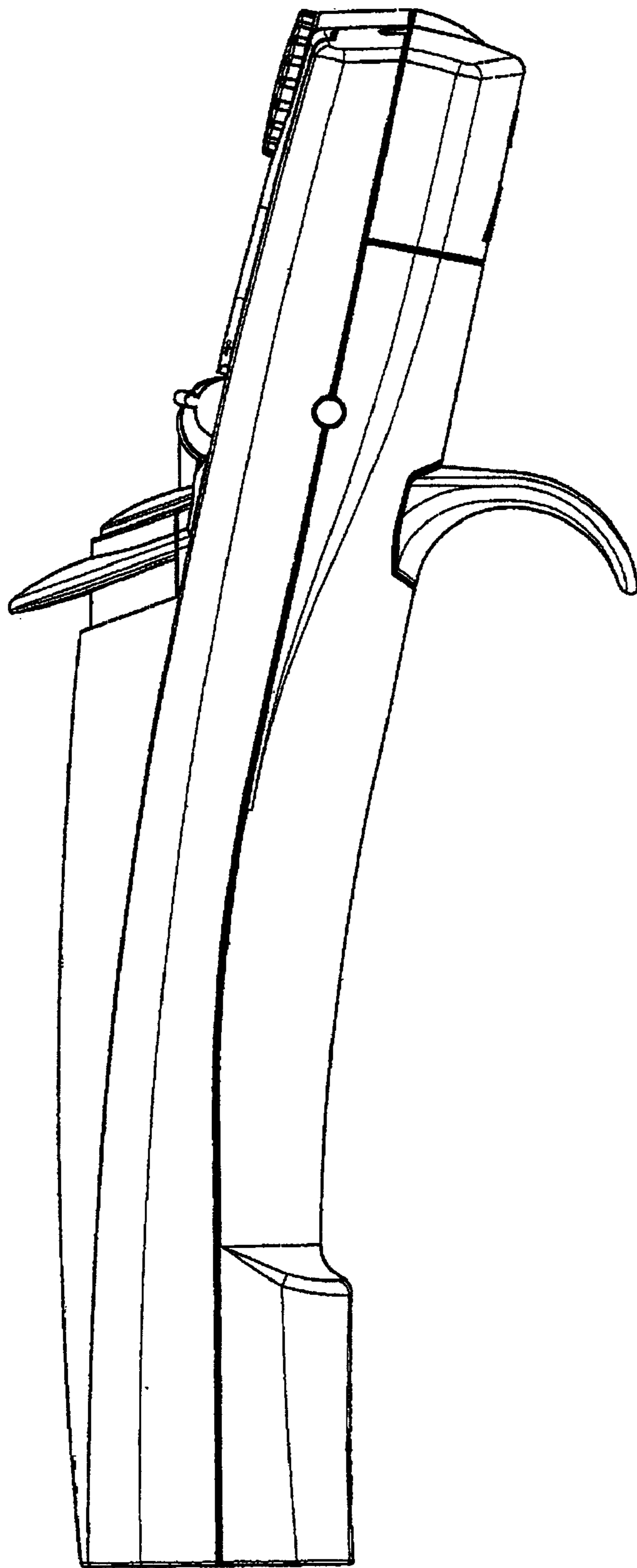

Fig. 3

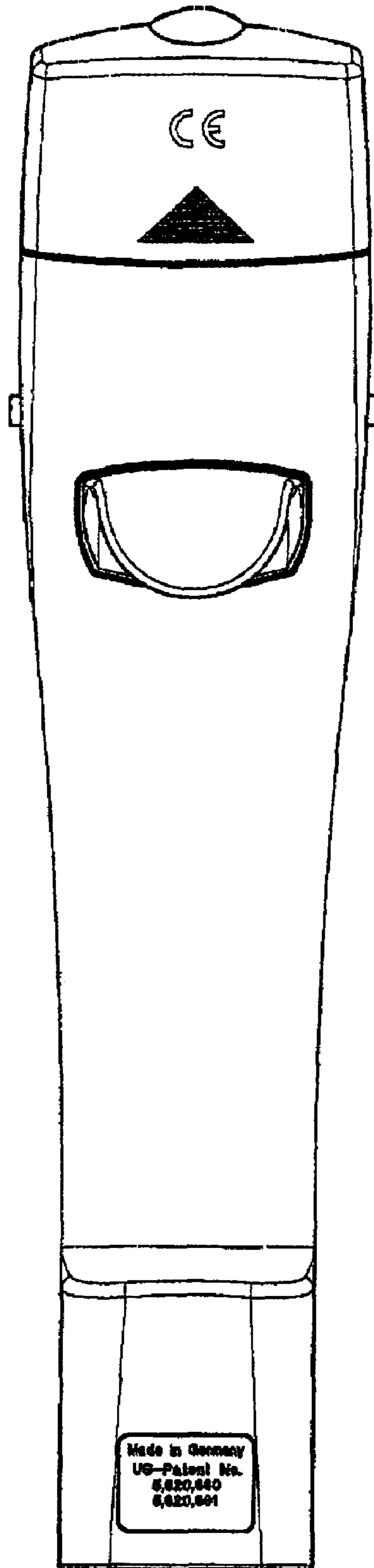

Fig. 4

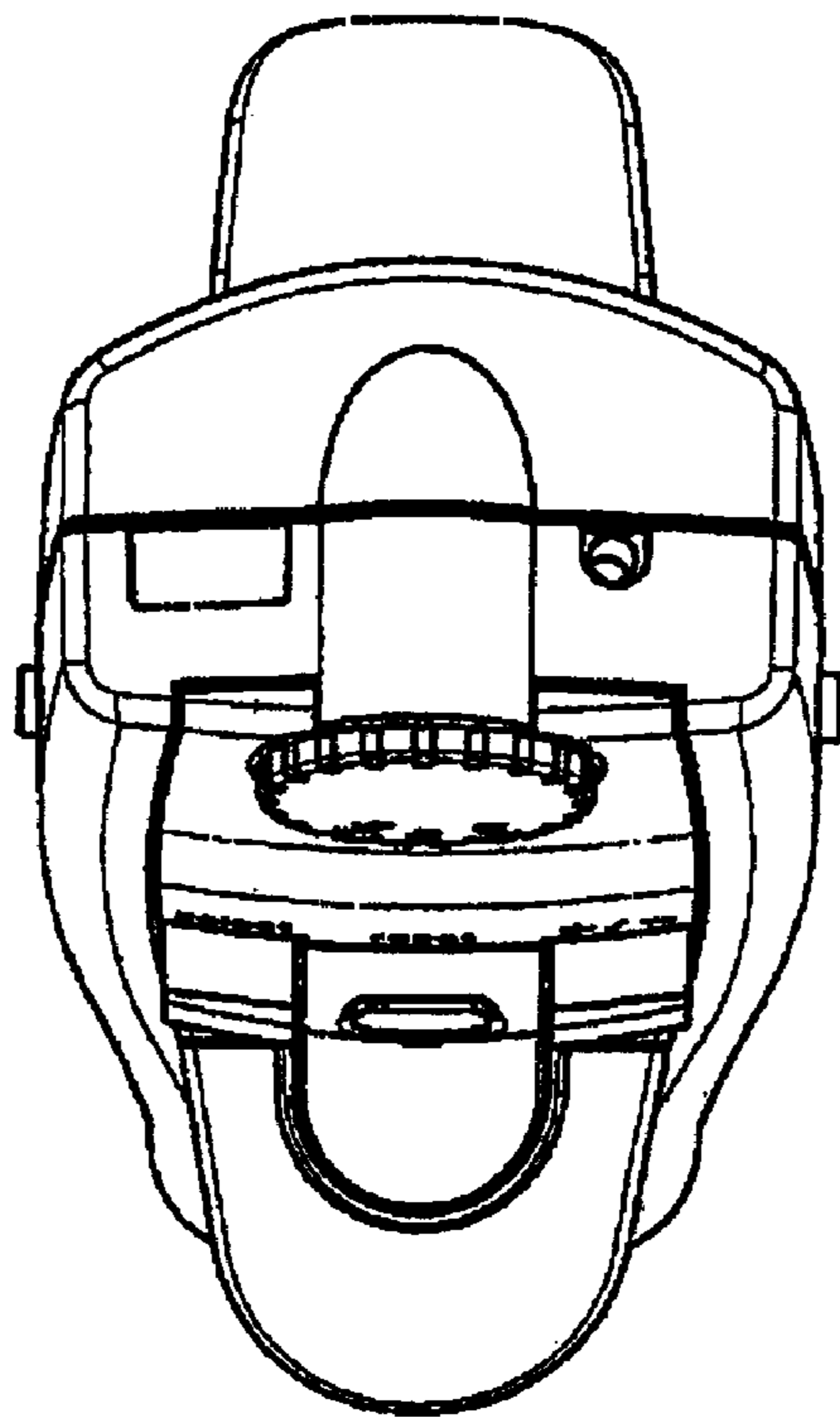

Fig. 5

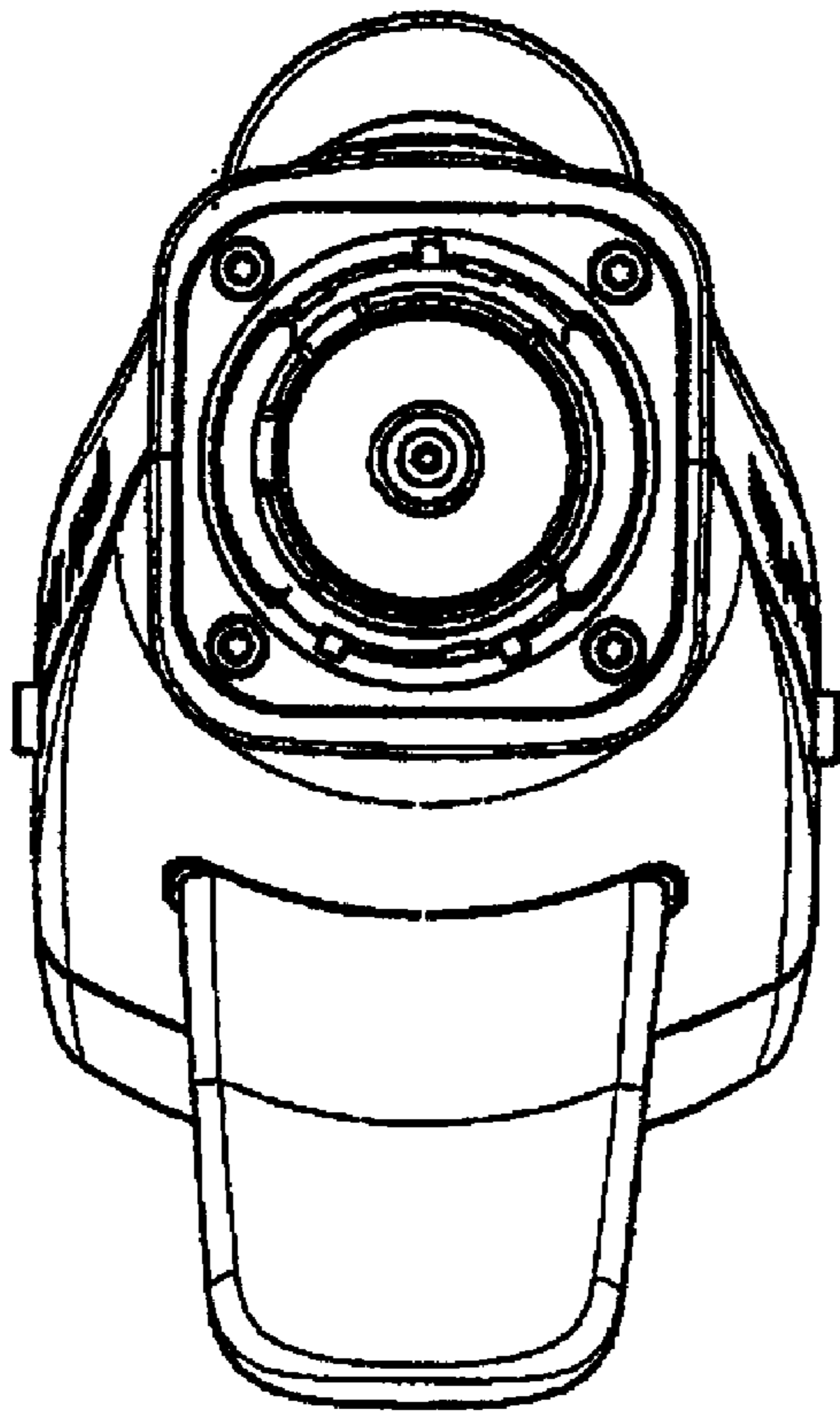

Fig. 6

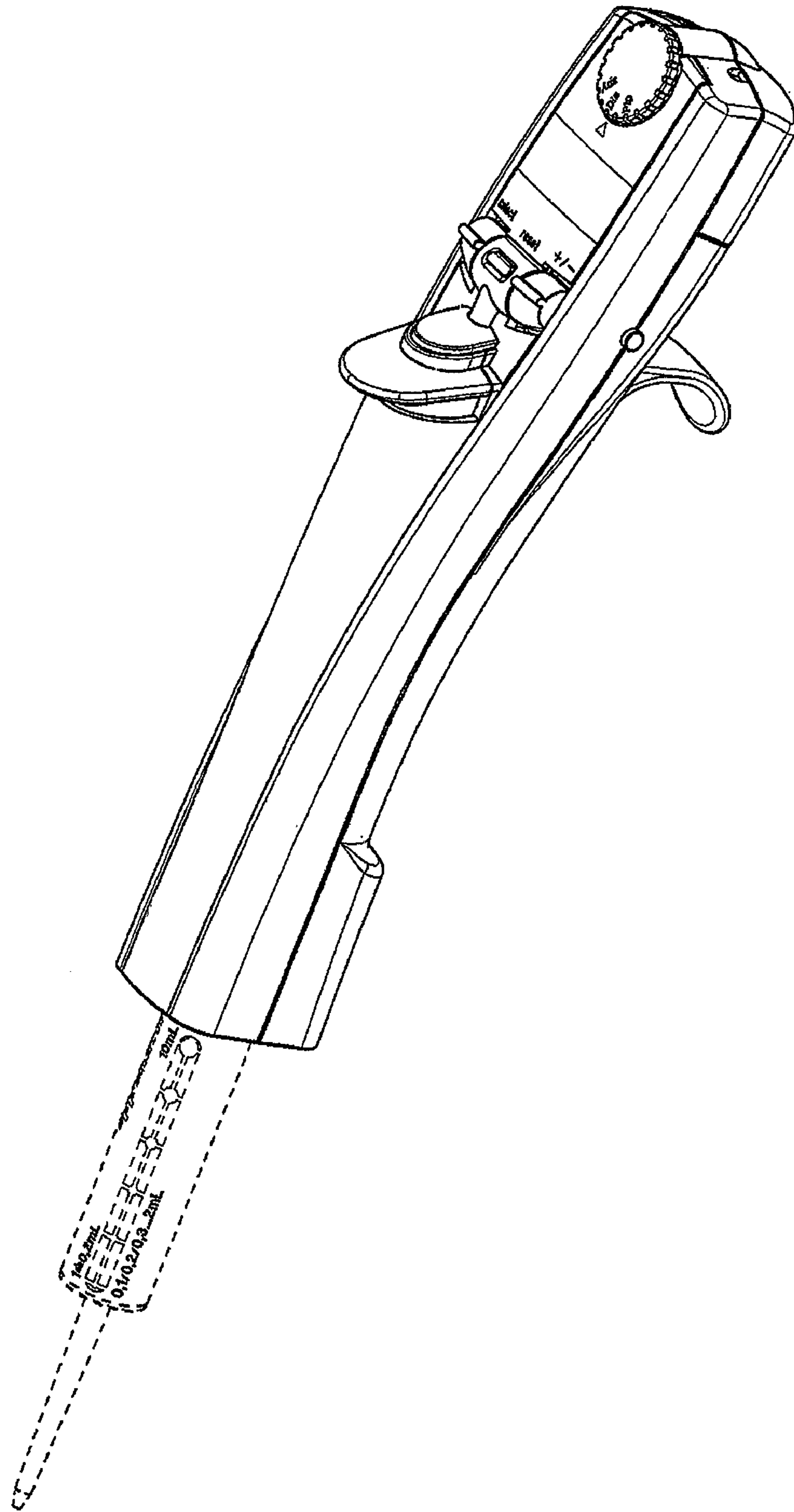

Fig. 7

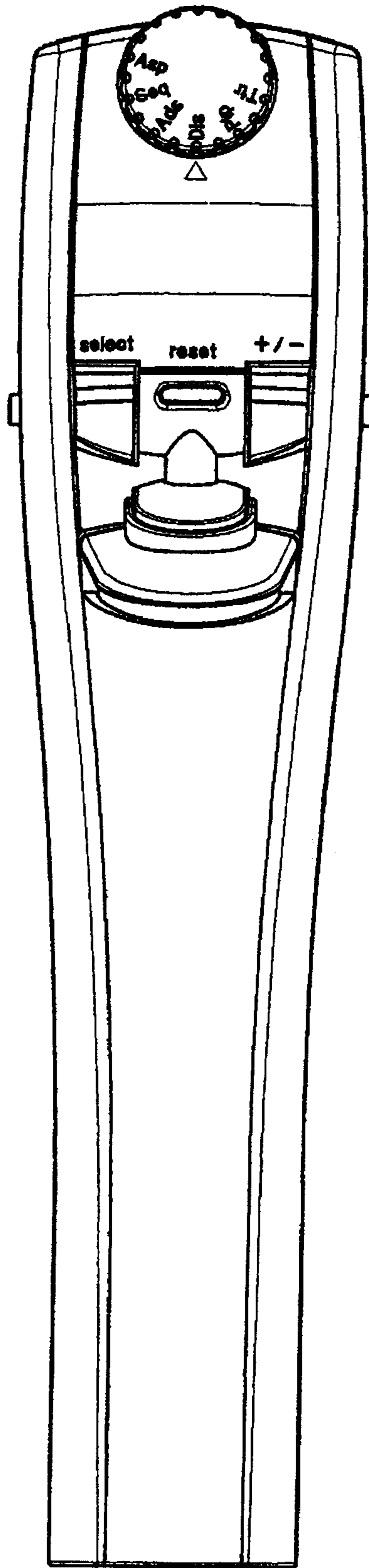

Fig. 8

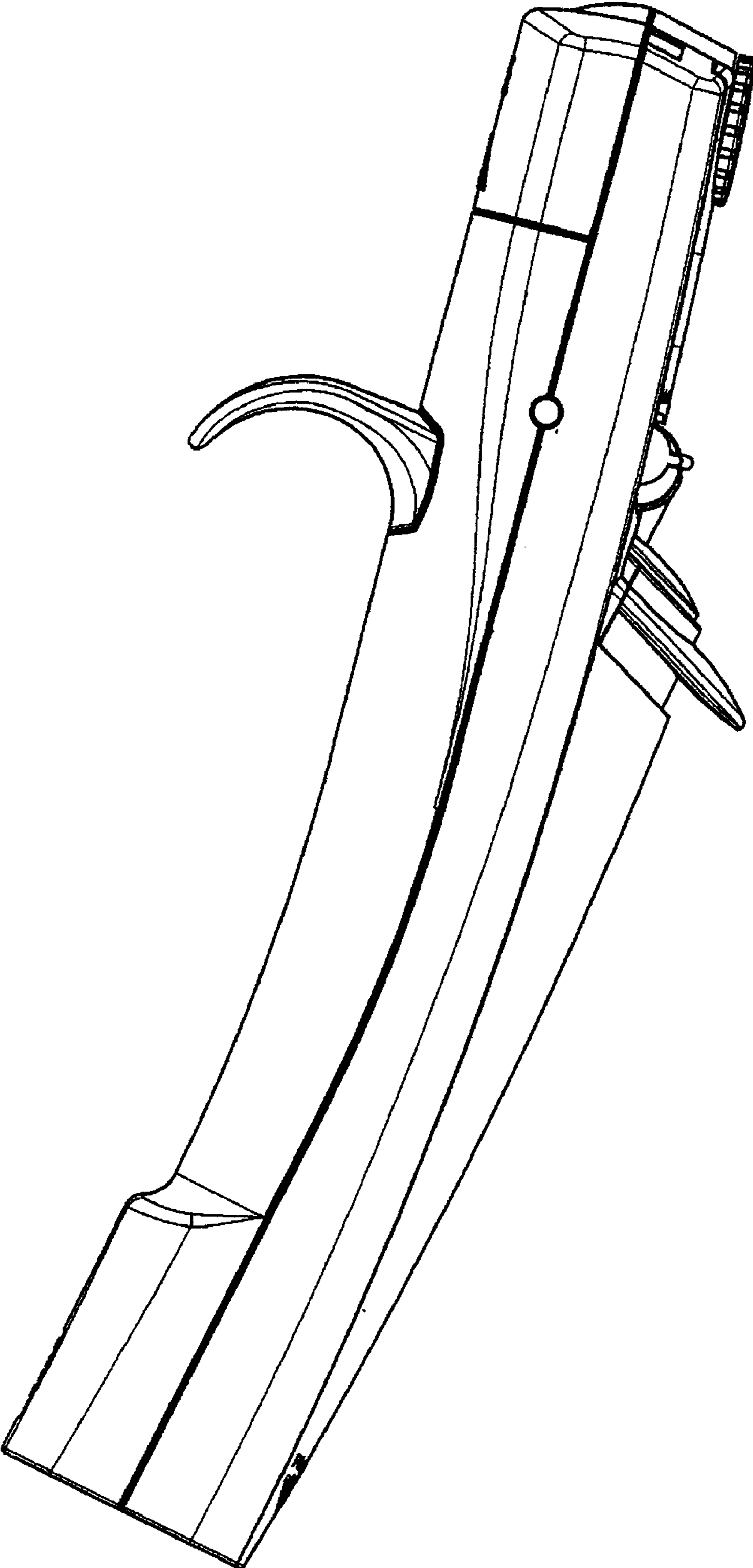

Fig. 9

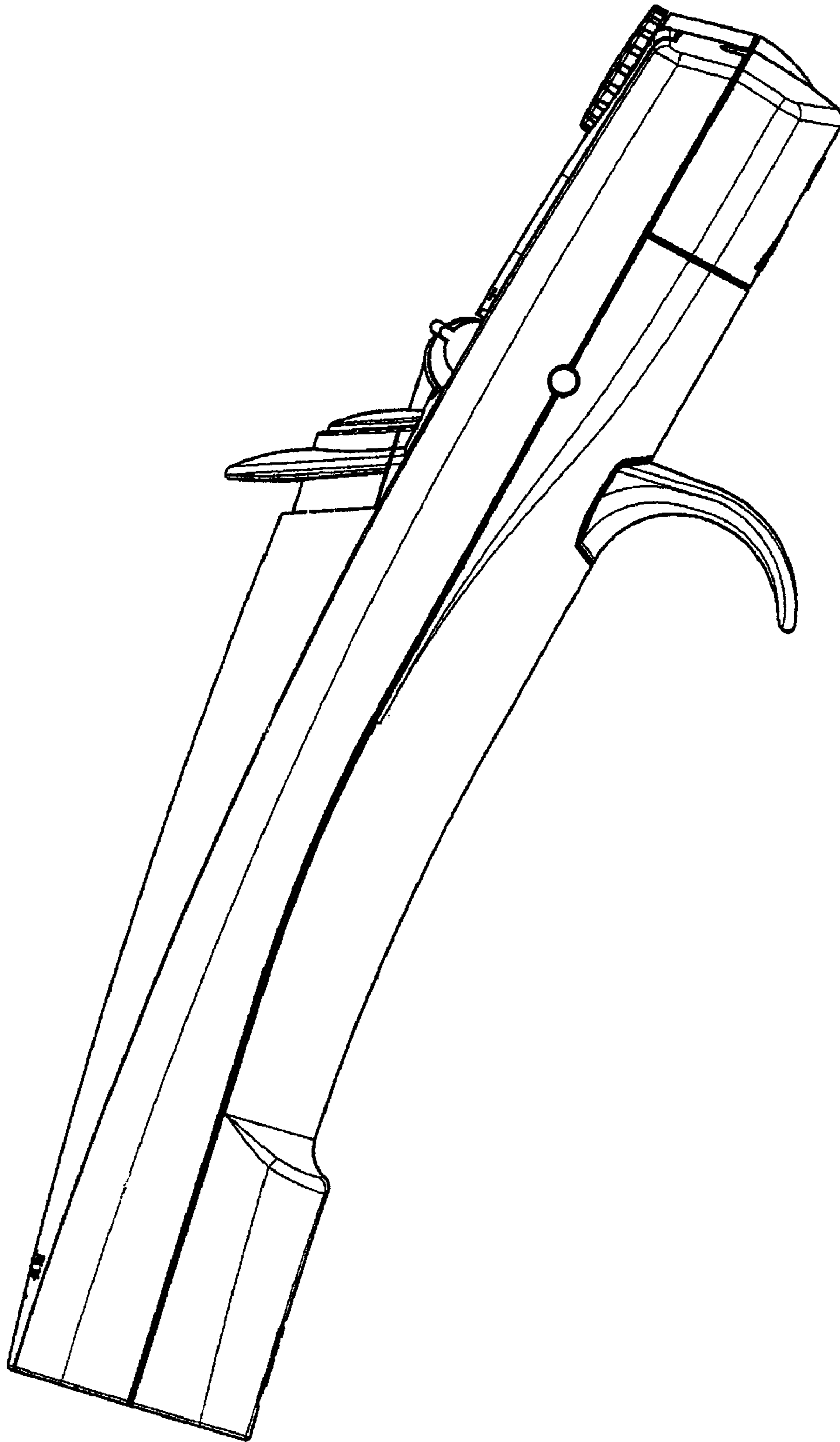

Fig. 10

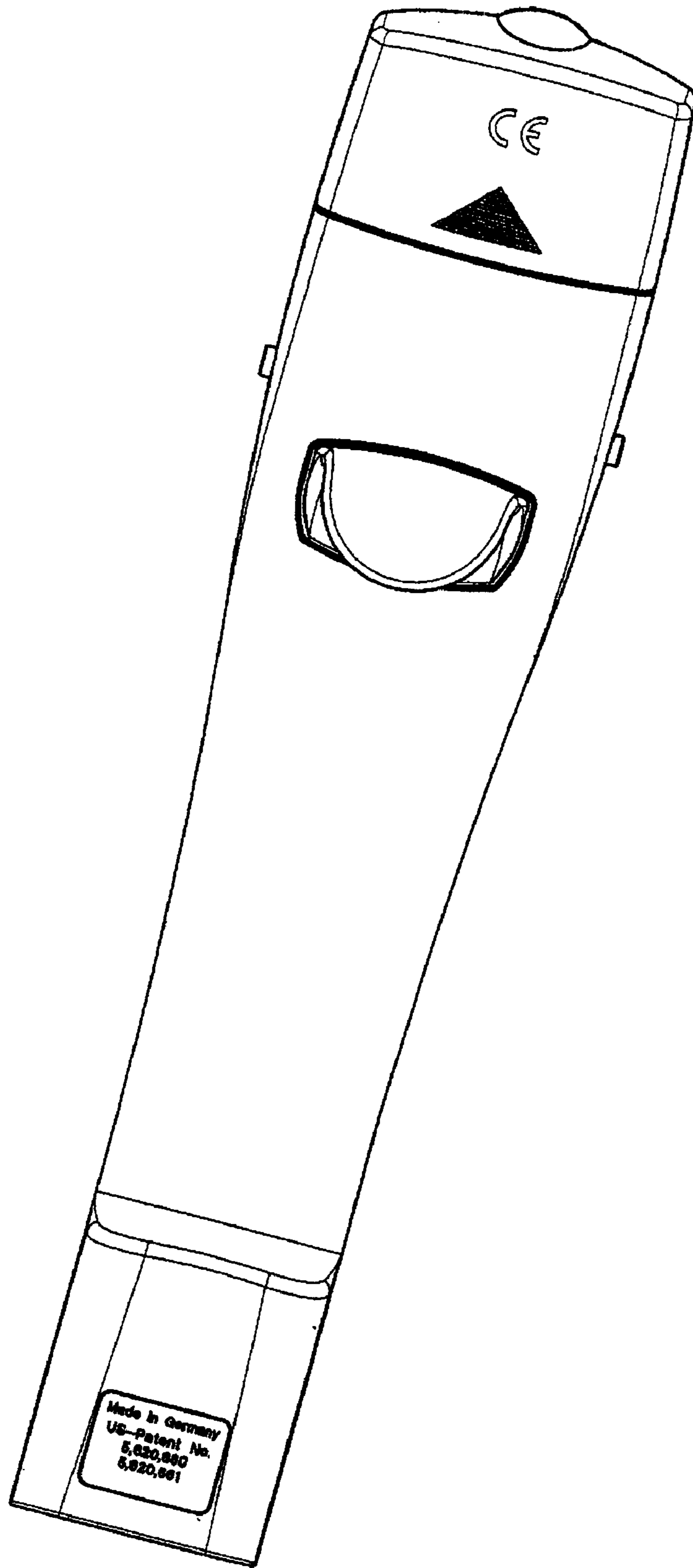

Fig. 11

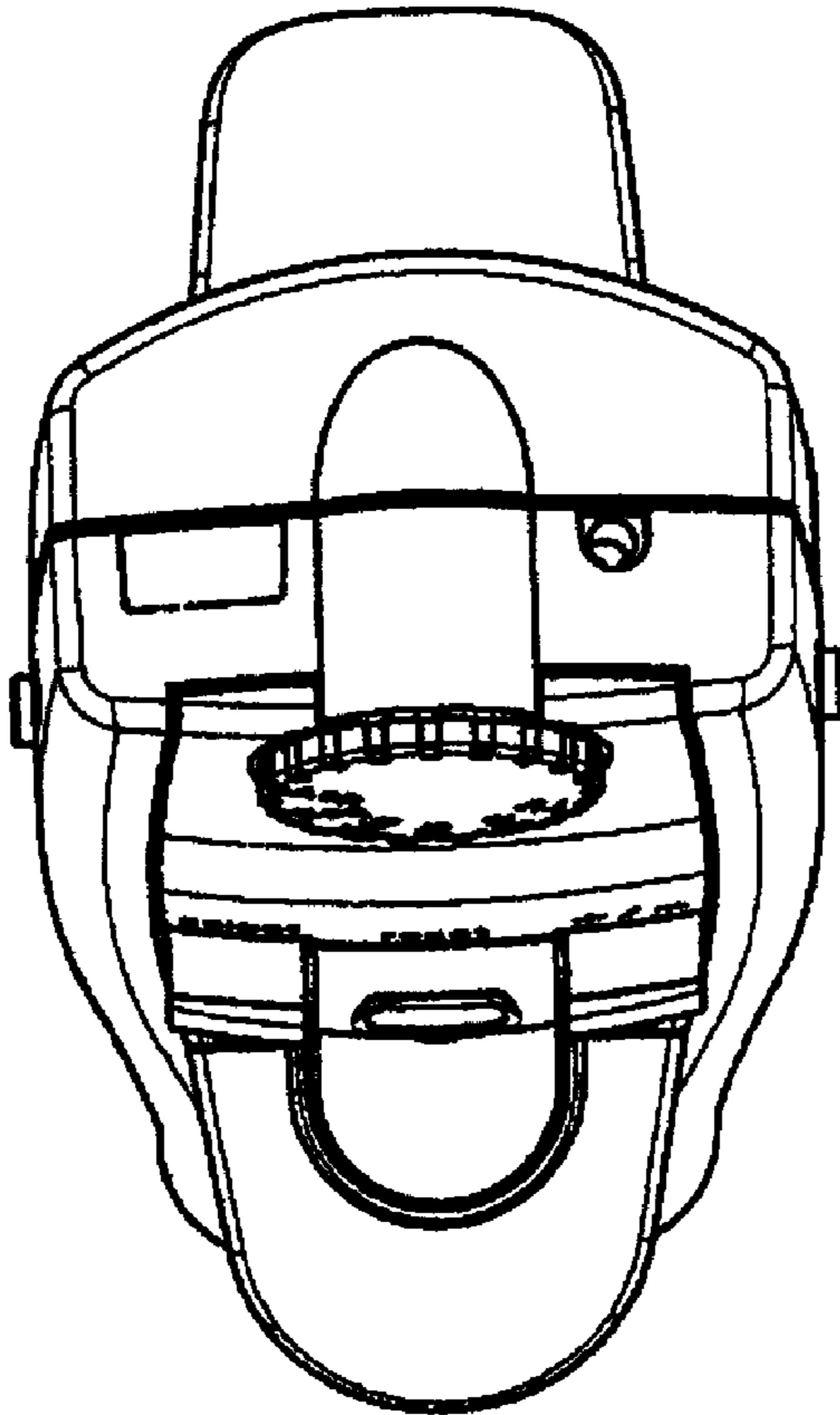

Fig. 12

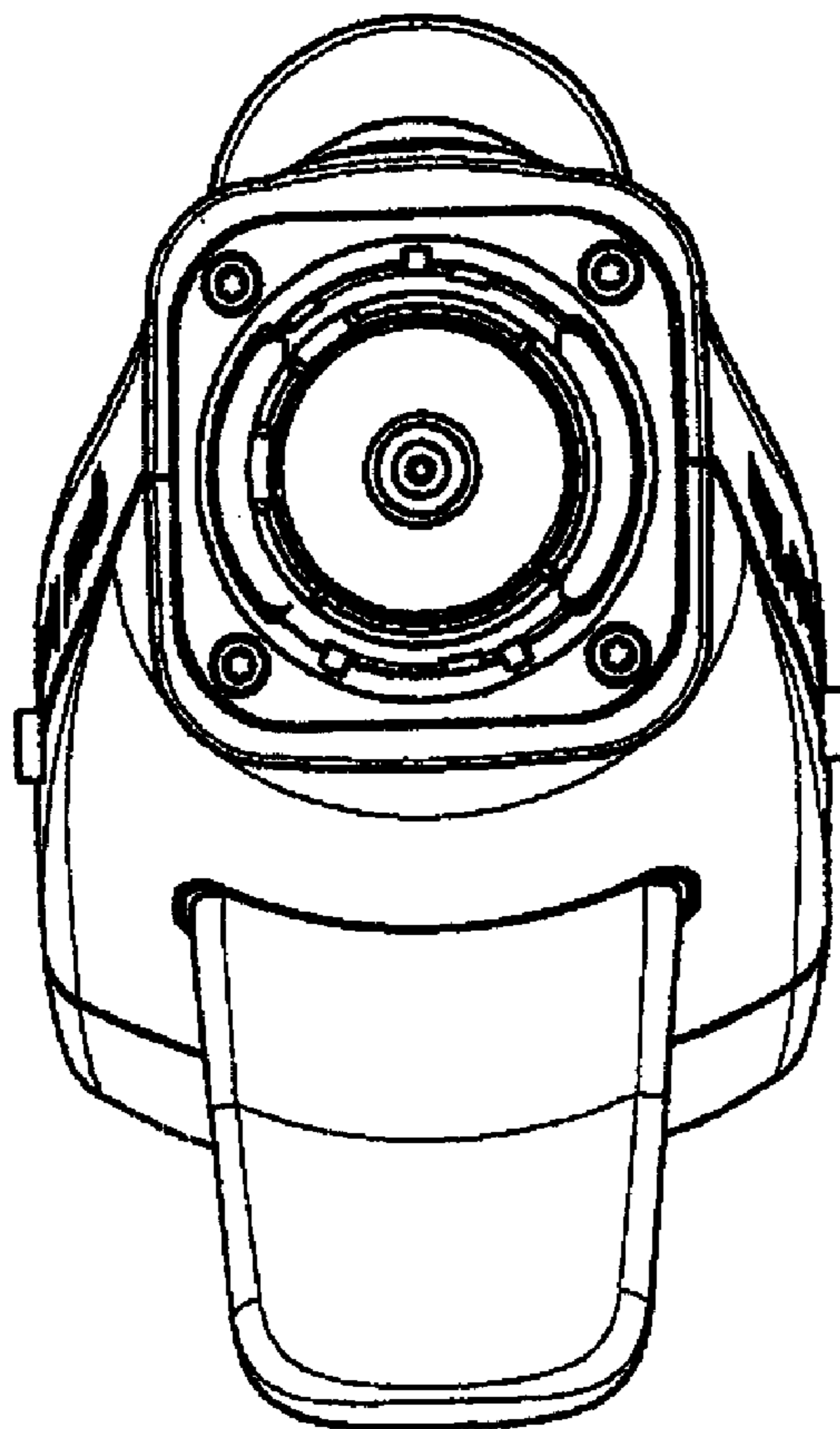

Fig. 13

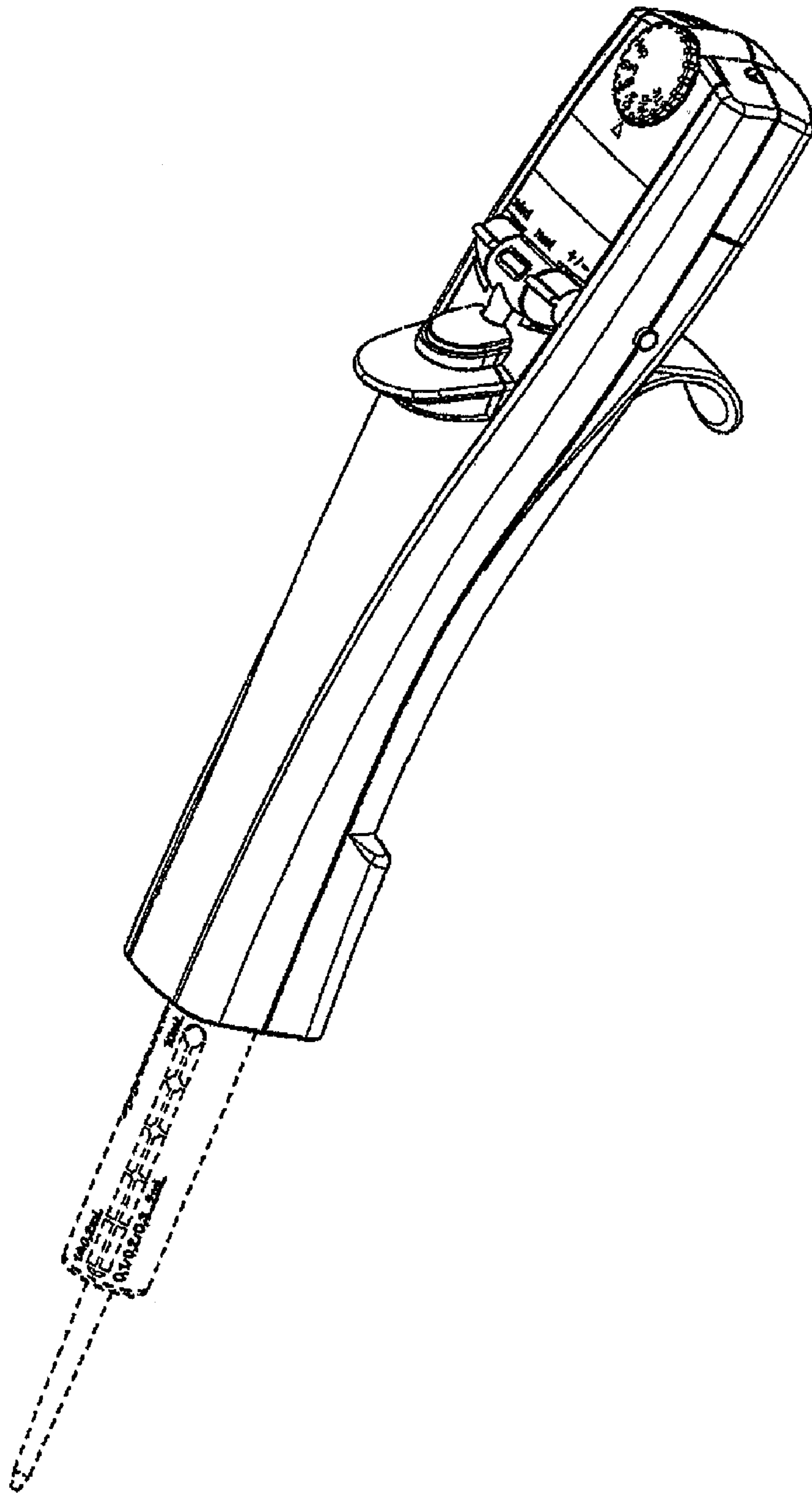

Fig. 14