

US00D548319S

(12) **United States Design Patent**  
**Triplett et al.**

(10) **Patent No.:** **US D548,319 S**

(45) **Date of Patent:** **\*\* Aug. 7, 2007**

(54) **AIR PURIFIER**

(75) Inventors: **Carl Triplett**, Scottsdale, AZ (US);  
**Christopher Joseph Wolpert**,  
Scottsdale, AZ (US); **Martina**  
**Spinatsch Kaiser**, Phoenix, AZ (US)

(73) Assignee: **The Dial Corporation**, Scottsdale, AZ  
(US)

(\*\*) Term: **14 Years**

(21) Appl. No.: **29/265,747**

(22) Filed: **Sep. 7, 2006**

(51) **LOC (8) Cl.** ..... **28-99**

(52) **U.S. Cl.** ..... **D23/366**

(58) **Field of Classification Search** ..... 261/DIG. 17,  
261/DIG. 42, DIG. 65, DIG. 88, DIG. 89;  
D23/355-369; D28/5, 6; 392/341, 342,  
392/386, 390, 392, 393, 394, 401; 239/34,  
239/35, 42, 60, 53-58, 136, 326; D11/43,  
D11/79

See application file for complete search history.

(56) **References Cited**

**U.S. PATENT DOCUMENTS**

4,214,146	A	*	7/1980	Schimanski	.....	392/390
4,391,781	A	*	7/1983	van Lit	.....	422/125
4,549,250	A	*	10/1985	Spector	.....	362/96
D349,157	S	*	7/1994	Rymer	.....	D23/362
D374,278	S		10/1996	Ganor		
D396,275	S	*	7/1998	Pearson	.....	D23/355
D400,662	S	*	11/1998	Davis	.....	D23/366

D411,000	S	*	6/1999	Moore	.....	D23/356
D456,070	S	*	4/2002	Garman	.....	D23/364
D457,230	S		5/2002	Huang		
D465,275	S	*	11/2002	Garman	.....	D23/364
D466,205	S	*	11/2002	Garcia	.....	D23/366
D468,820	S		1/2003	Smith et al.		
D476,068	S		6/2003	Carey et al.		
D492,760	S		7/2004	Garman		
D532,893	S	*	11/2006	Wu	.....	D23/366

\* cited by examiner

*Primary Examiner*—Sandra Snapp

(74) *Attorney, Agent, or Firm*—Paul A. Pappalardo; A. Kate Huffman

(57) **CLAIM**

The ornamental design for an air purifier, as shown and described.

**DESCRIPTION**

FIG. 1 is a right, front, upper perspective view of an air purifier embodying our new design;

FIG. 2 is a front side elevation view thereof;

FIG. 3 is a rear side elevation view thereof;

FIG. 4 is a right side elevation view thereof;

FIG. 5 is a left side elevation view thereof;

FIG. 6 is a top plan view thereof; and,

FIG. 7 is a bottom plan view thereof.

The broken lines shown in the drawings are for illustrative purposes only and form no part of the claimed design.

**1 Claim, 4 Drawing Sheets**

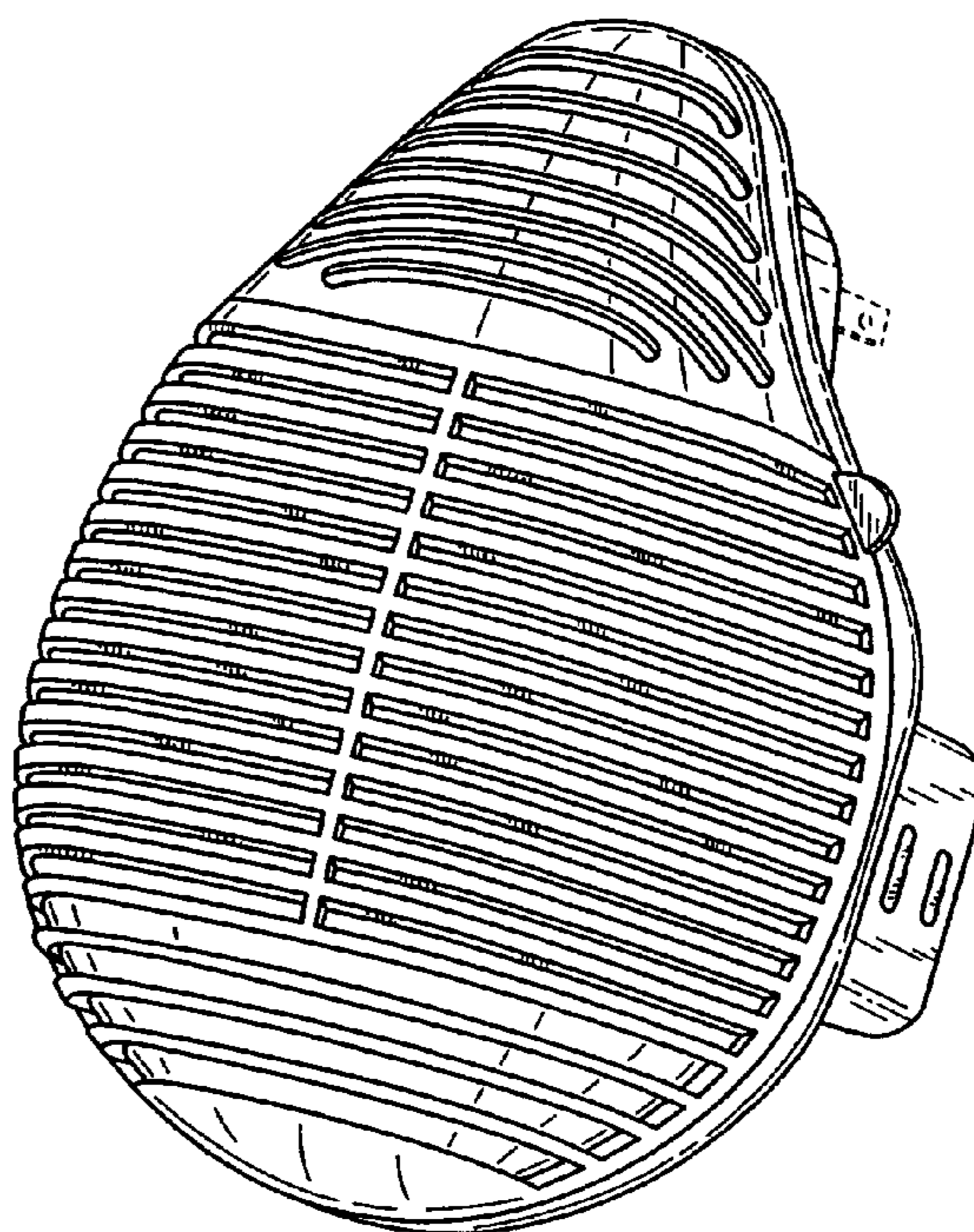

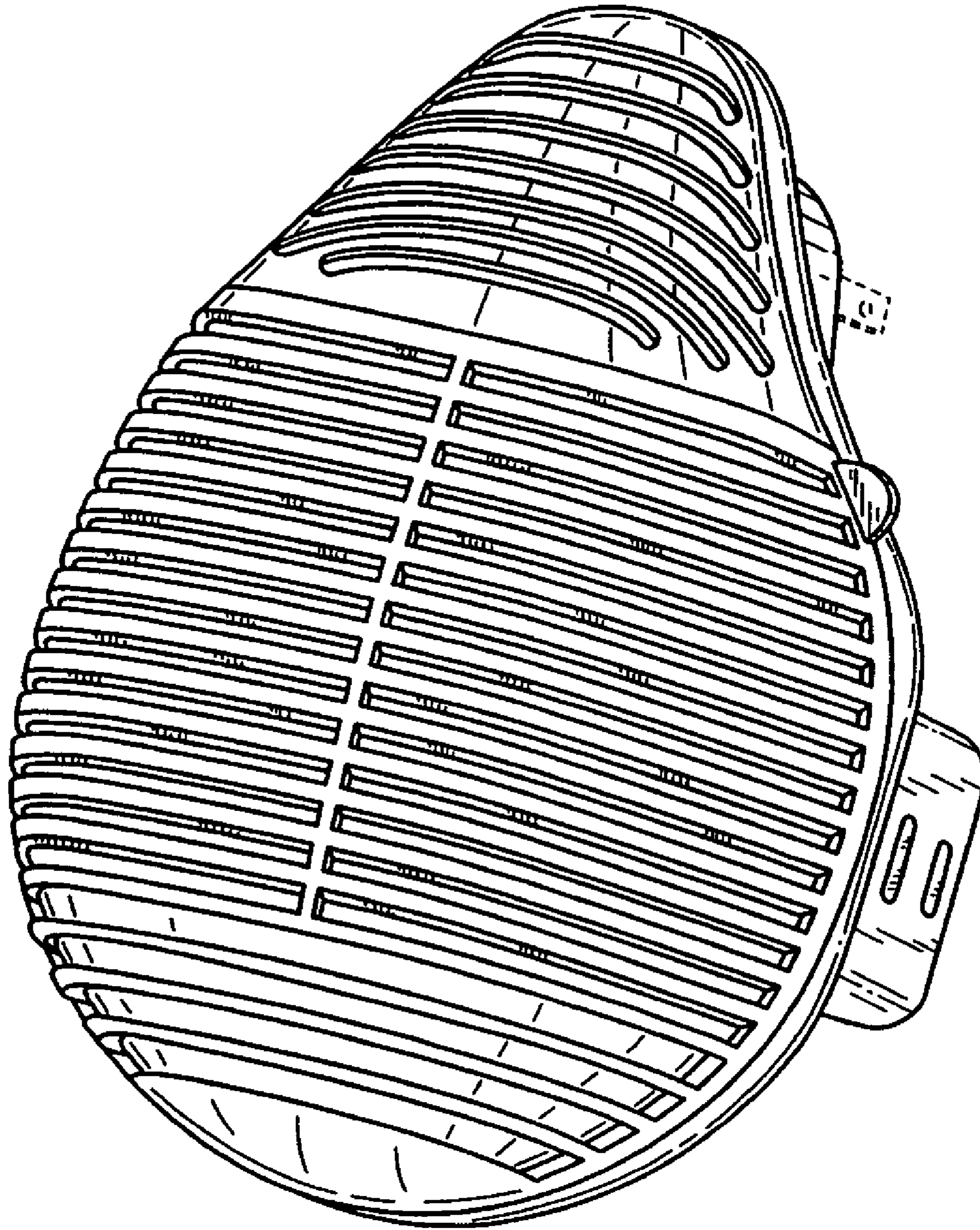

FIG. 1

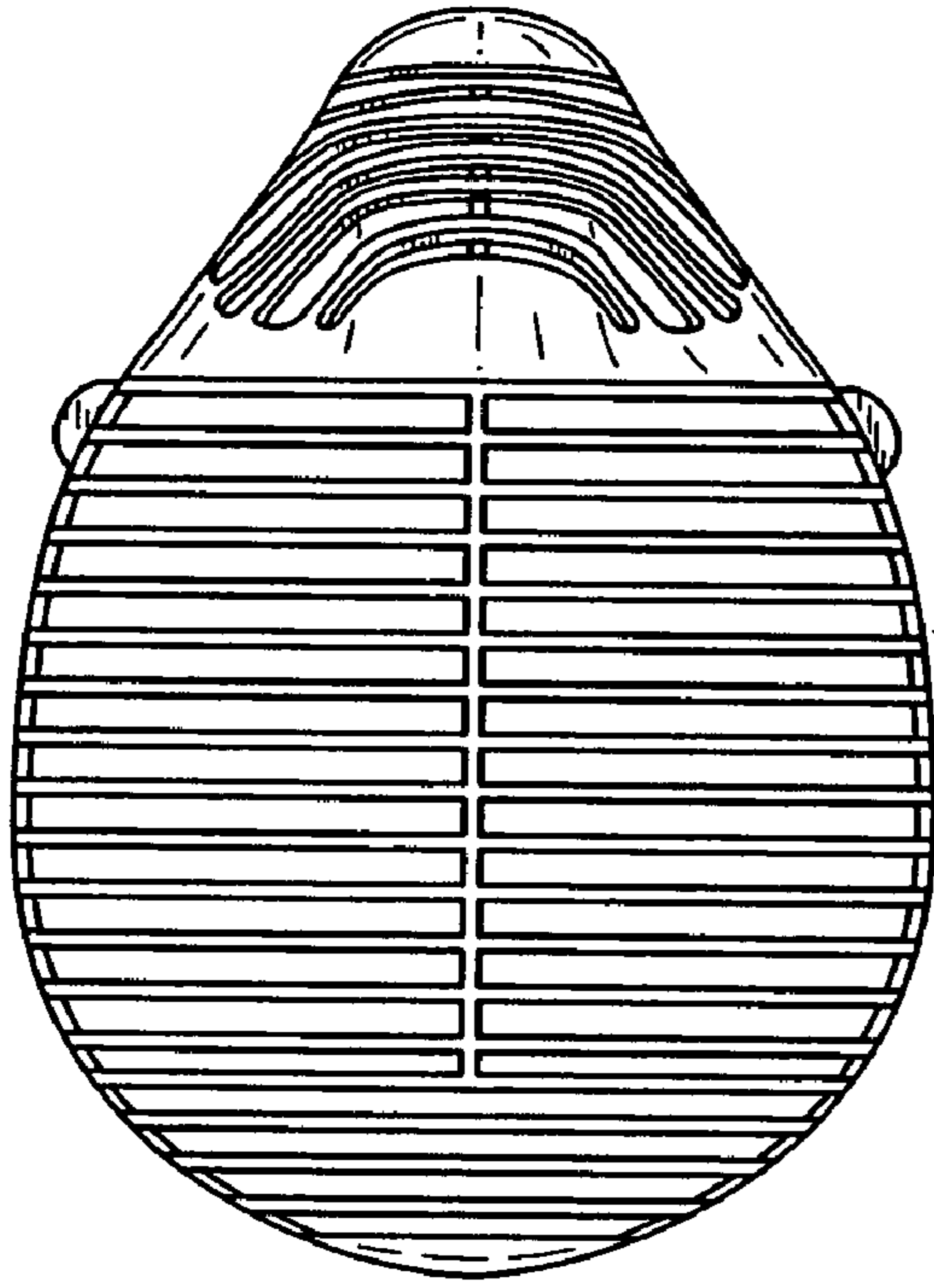

FIG. 2

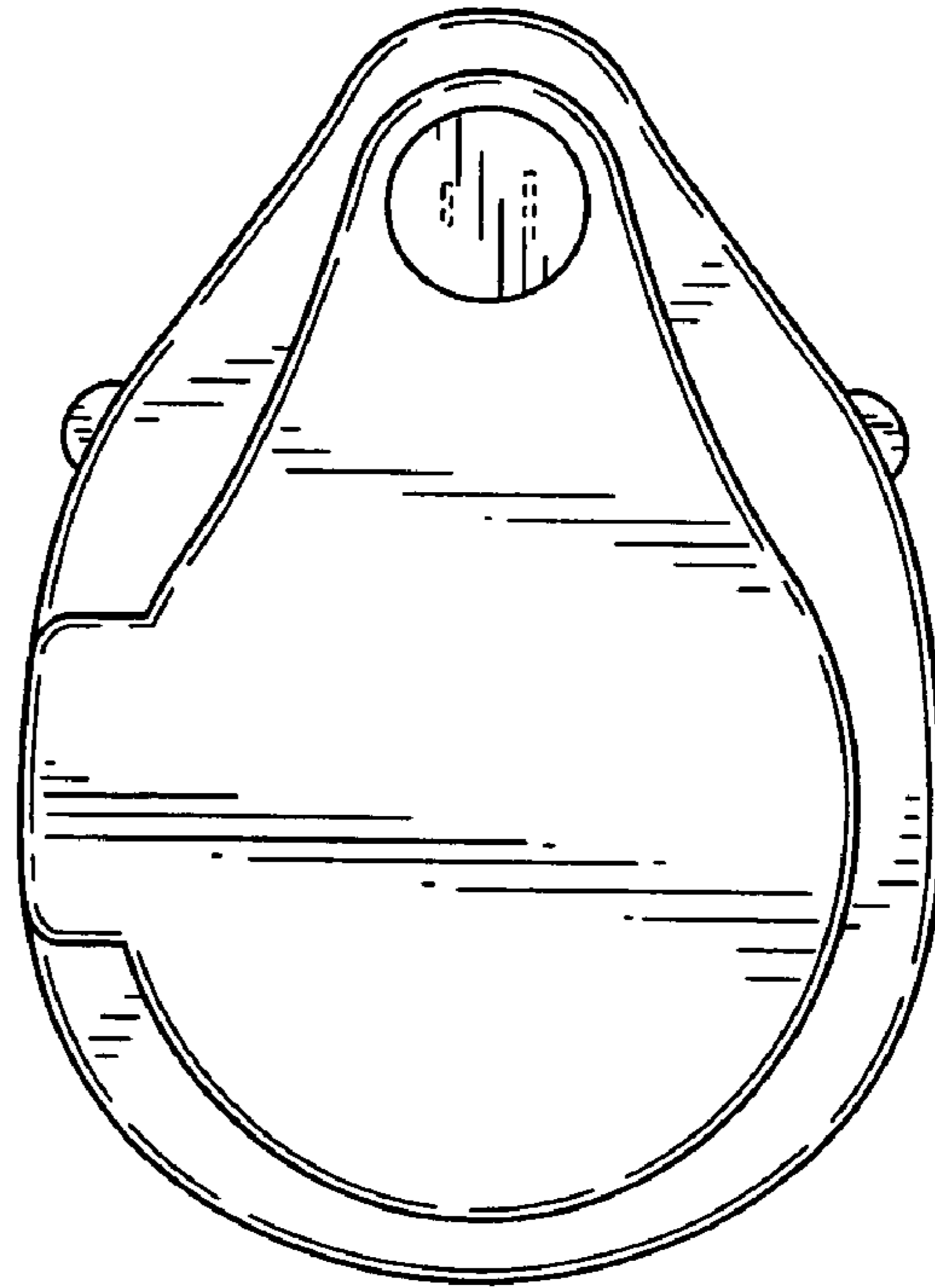

FIG. 3

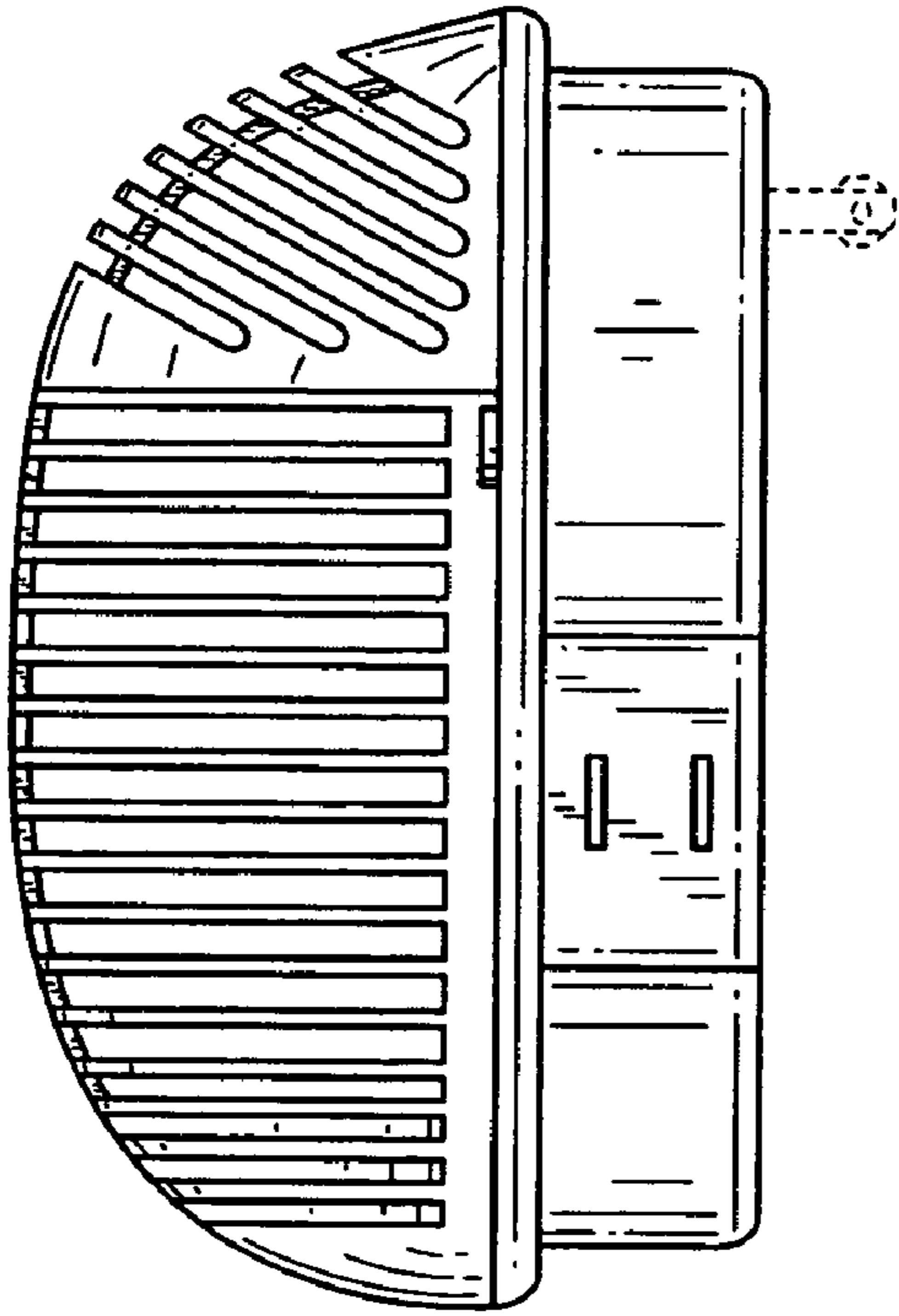

FIG. 4

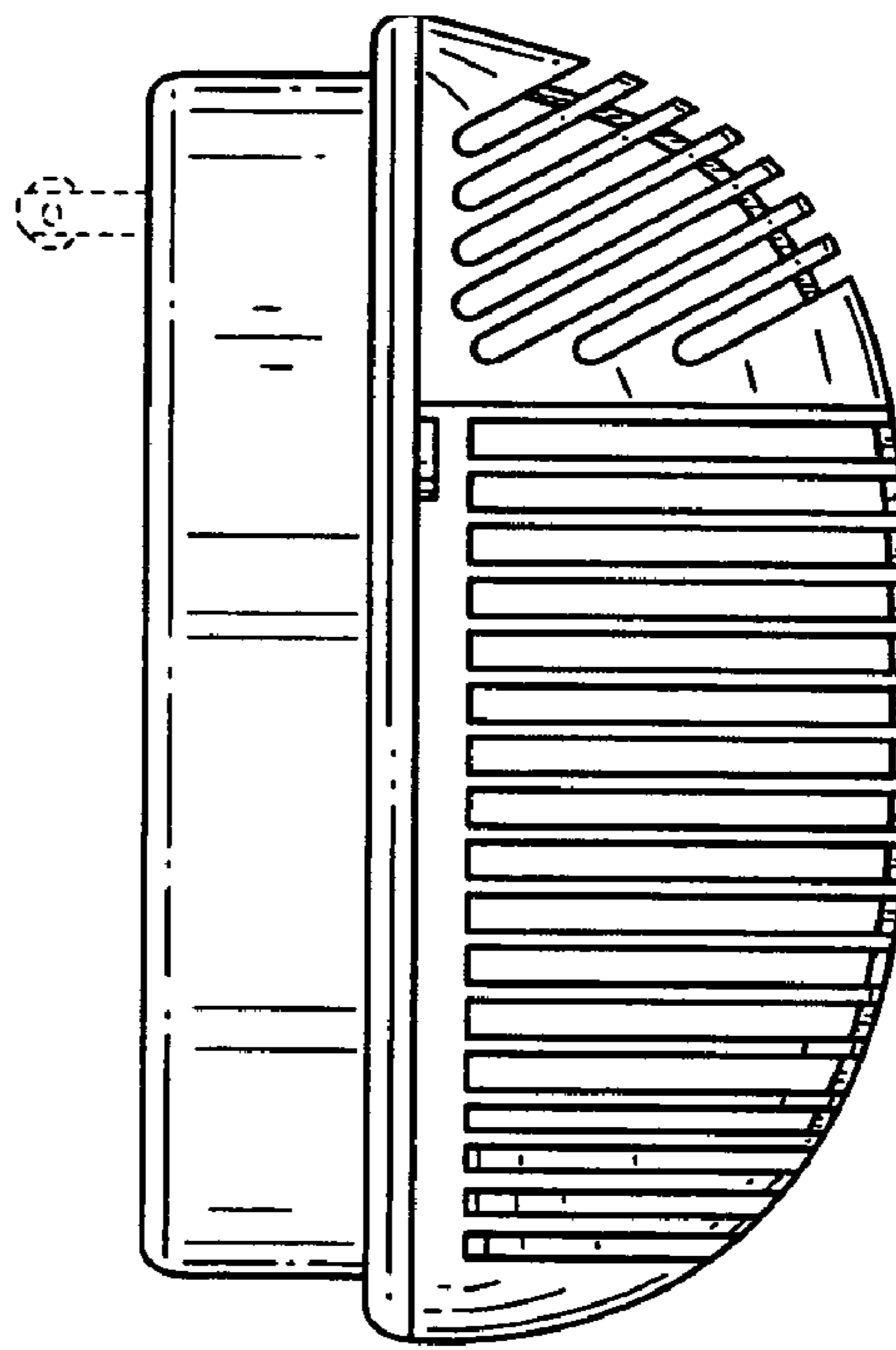

FIG. 5

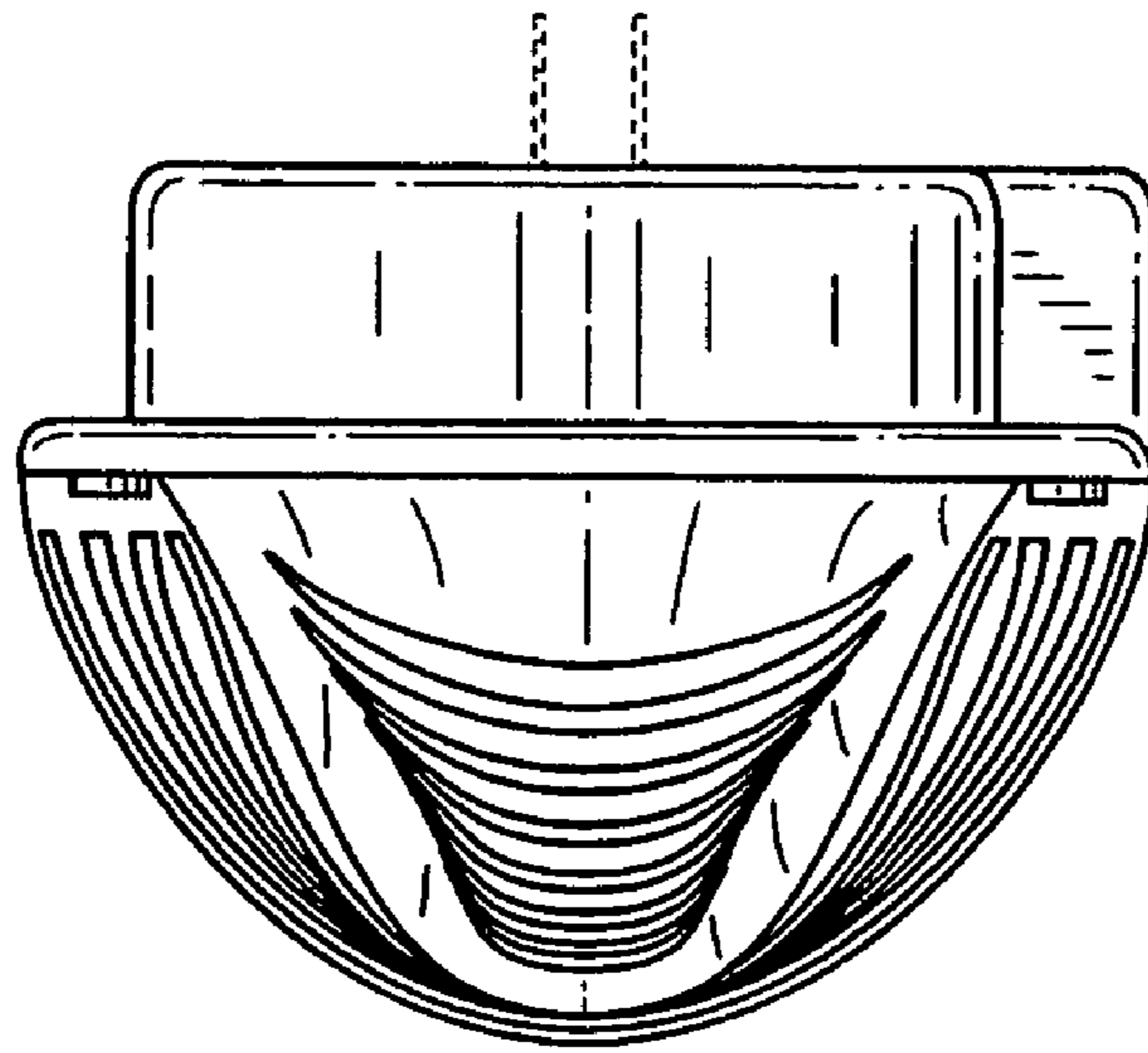

FIG. 6

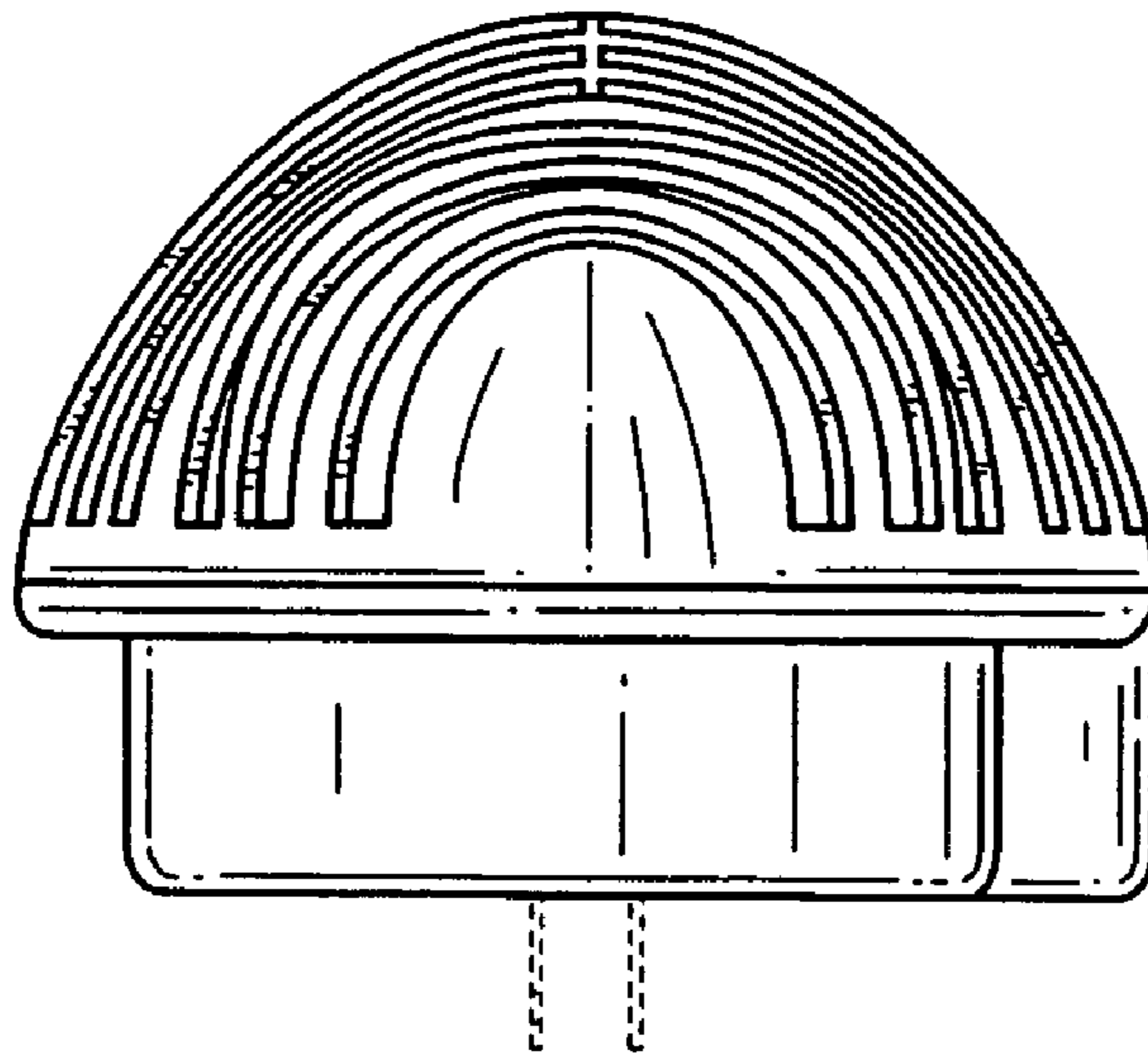

FIG. 7