



US00D548249S

(12) **United States Design Patent**
Okamoto et al.

(10) **Patent No.:** **US D548,249 S**

(45) **Date of Patent:** **** Aug. 7, 2007**

(54) **REFRIGERATOR**

(75) Inventors: **Yasutoshi Okamoto**, Ashikaga (JP);
Hidehiko Sato, Oota (JP); **Akihiro**
Mochizuki, Oizumi-machi (JP)

(73) Assignee: **Sanyo Electric Co., Ltd.**,
Moriguchi-shi, Osaka-fu (JP)

(**) Term: **14 Years**

(21) Appl. No.: **29/267,606**

(22) Filed: **Oct. 18, 2006**

(30) **Foreign Application Priority Data**

Apr. 26, 2006 (JP) 2006-010766

(51) **LOC (8) Cl.** **15-07**

(52) **U.S. Cl.** **D15/84**

(58) **Field of Classification Search** D15/79,
D15/81, 83, 84; 62/3.1, 3.6, 3.63, 3.64, 389-400,
62/440, 441; D7/605-607; 312/236, 352,
312/400-406, 116, 223.5; D6/329, 396,
D6/397, 432, 449, 479, 470-474

See application file for complete search history.

(56) **References Cited**

U.S. PATENT DOCUMENTS

D256,587 S * 8/1980 Tatsumi D15/83
D354,292 S * 1/1995 Monti D15/80
D394,270 S * 5/1998 Strandell et al. D15/80
D491,581 S * 6/2004 Jang et al. D15/83
D501,489 S * 2/2005 Seo et al. D15/83
D501,663 S * 2/2005 Yu et al. D15/83

D507,282 S * 7/2005 Lee et al. D15/83
D507,283 S * 7/2005 Lee et al. D15/83
D507,584 S * 7/2005 Kim et al. D15/83
D510,743 S * 10/2005 Kim et al. D15/83
D516,099 S * 2/2006 Maruyama D15/83

* cited by examiner

Primary Examiner—Stella Reid

Assistant Examiner—Shanda C. Hill

(74) *Attorney, Agent, or Firm*—Christopher & Weisberg,
P.A.

(57) **CLAIM**

The ornamental design for a refrigerator, as shown and
described.

DESCRIPTION

FIG. 1 is a front elevational view of a refrigerator showing
our new design;

FIG. 2 is a rear elevational view thereof;

FIG. 3 is a top plan view thereof;

FIG. 4 is a bottom plan view thereof;

FIG. 5 is a right-side elevational view thereof;

FIG. 6 is a left-side elevational view thereof;

FIG. 7 is a perspective view of FIG. 1;

FIG. 8 is a perspective view of FIG. 7 with a first door in an
open position; and,

FIG. 9 is a perspective view of FIG. 7 with a second door in
an open position.

FIGS. 7, 8 and 9 are shown on a reduced scale.

1 Claim, 5 Drawing Sheets

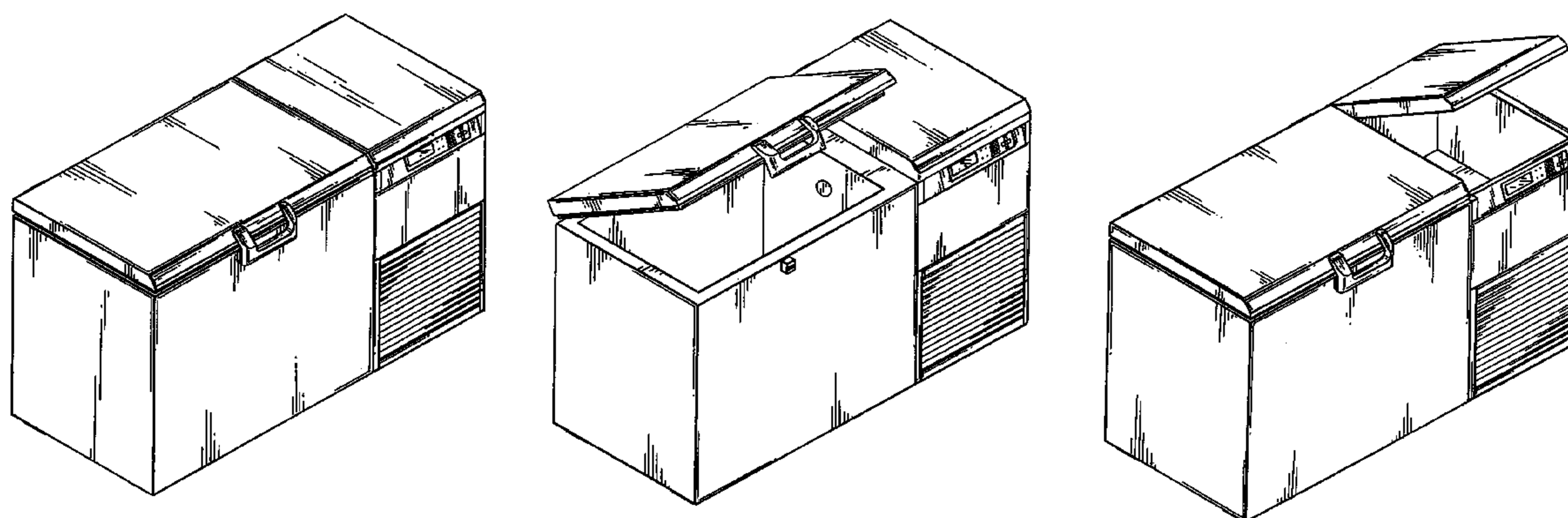

Fig. 1

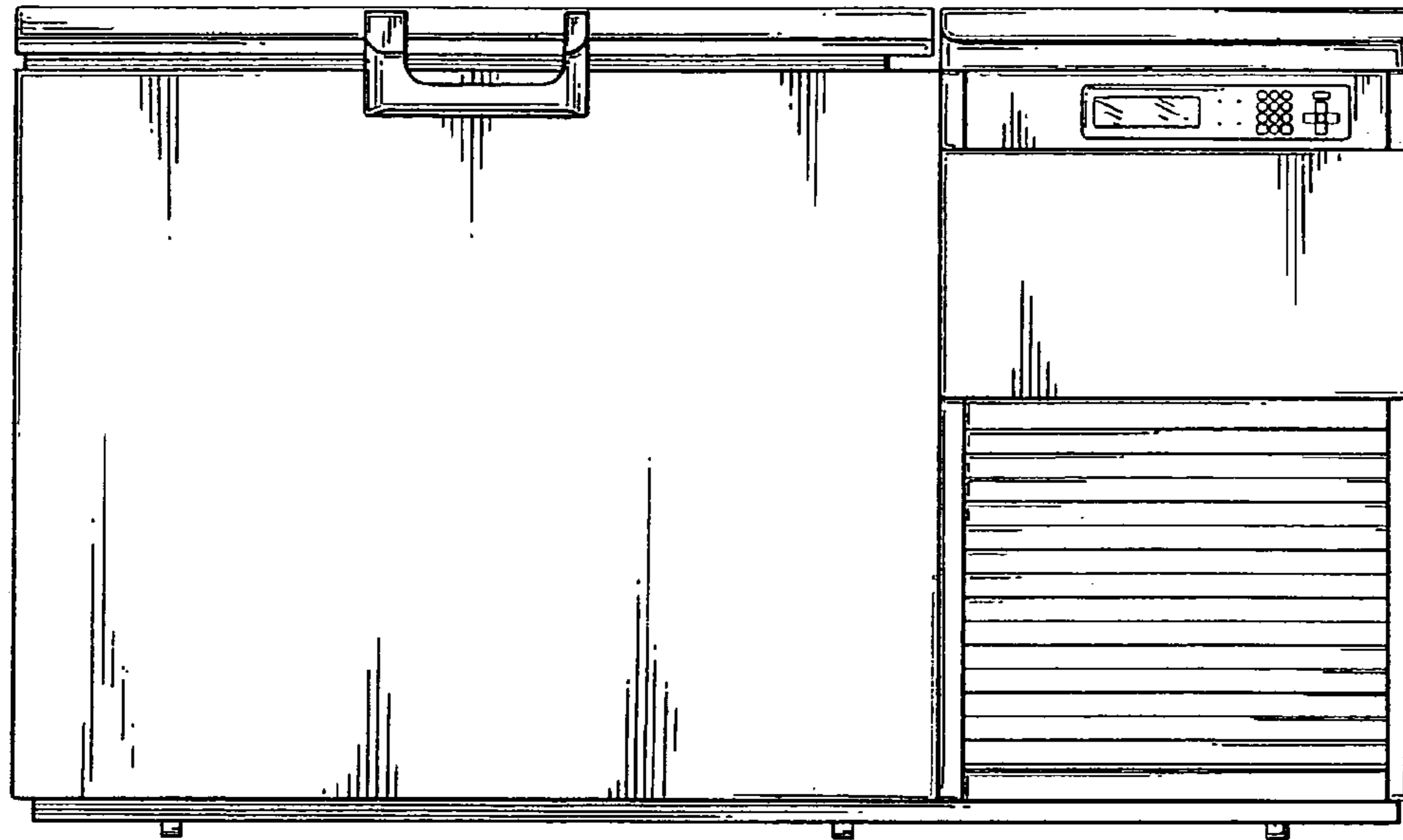

Fig. 2

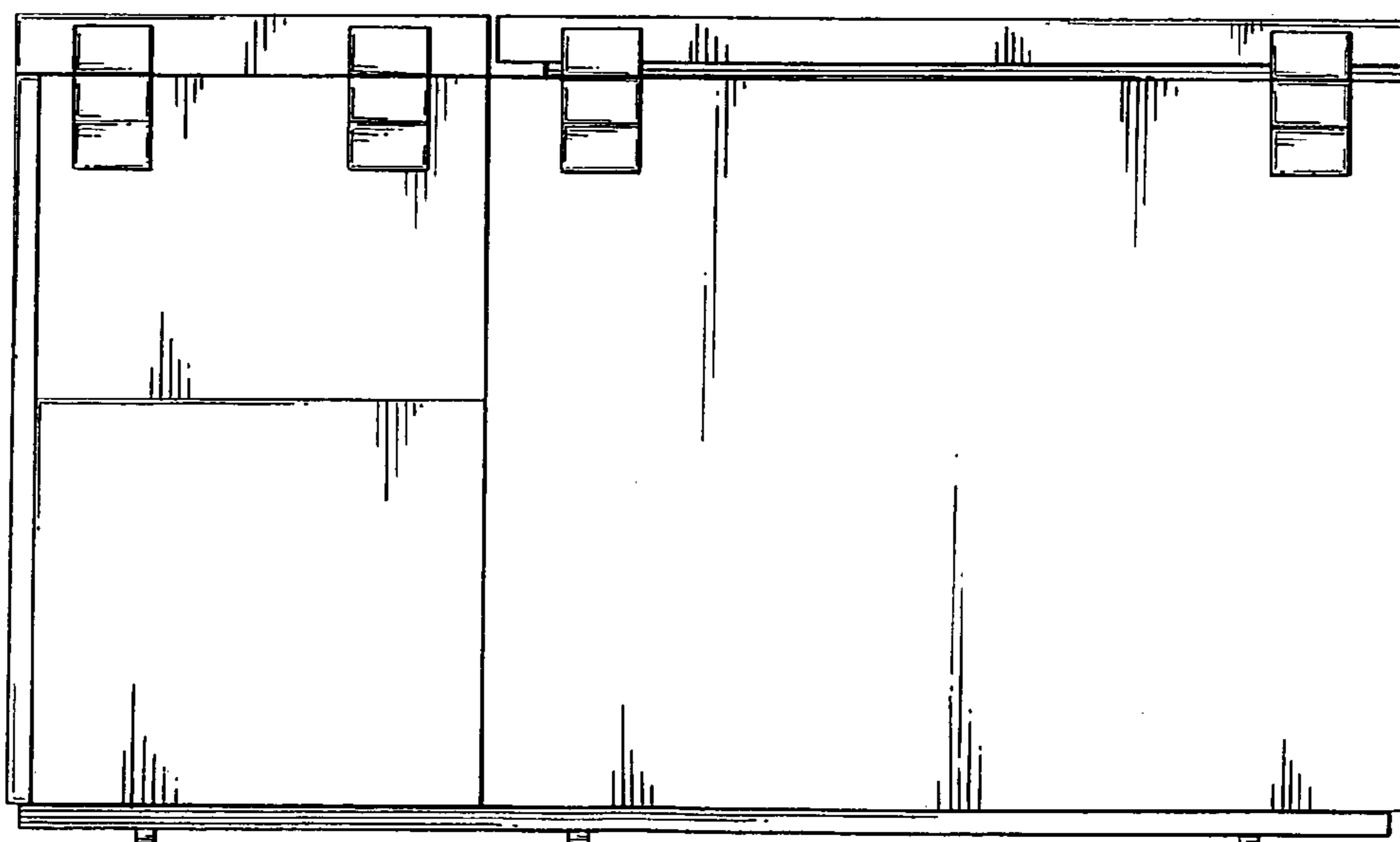

Fig. 3

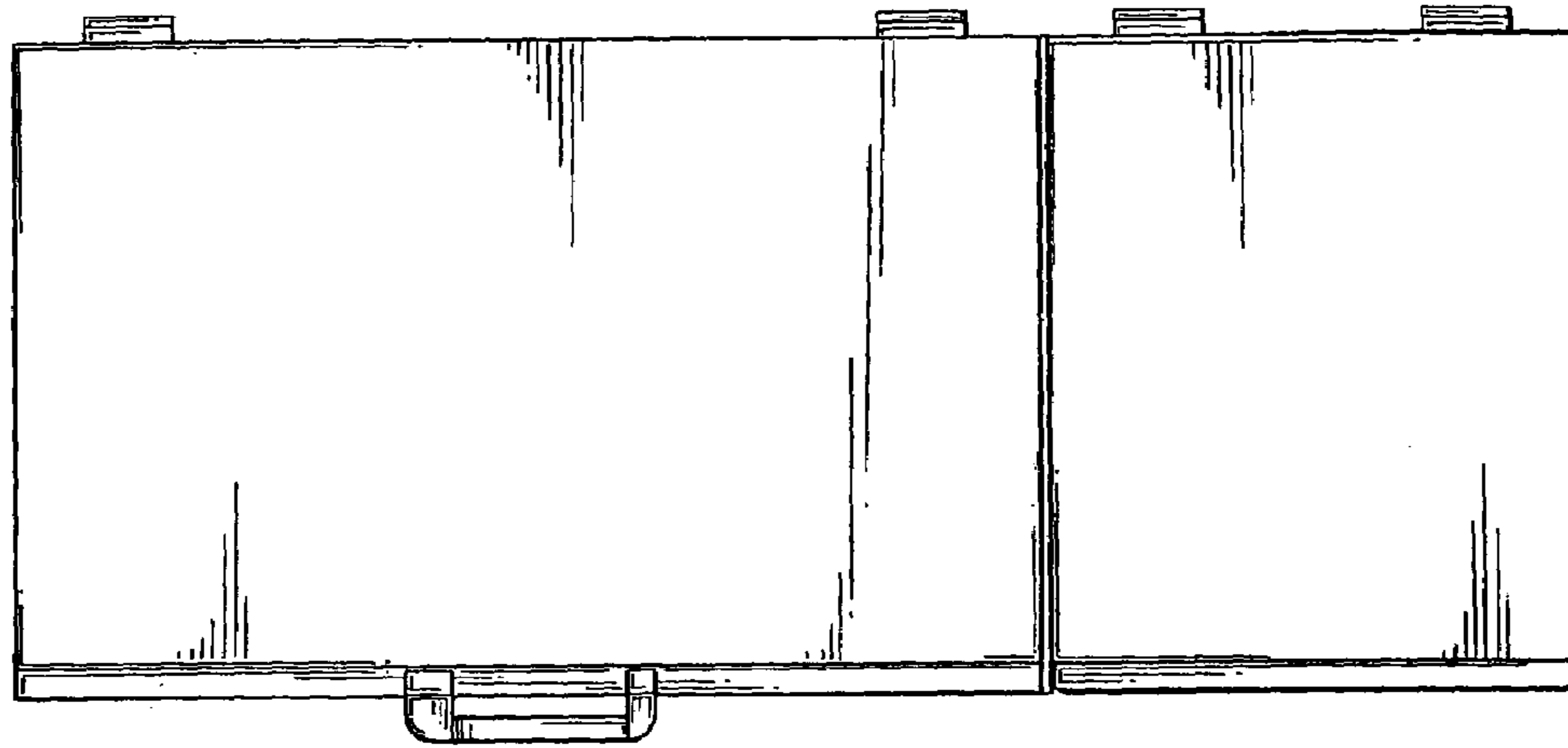

Fig. 4

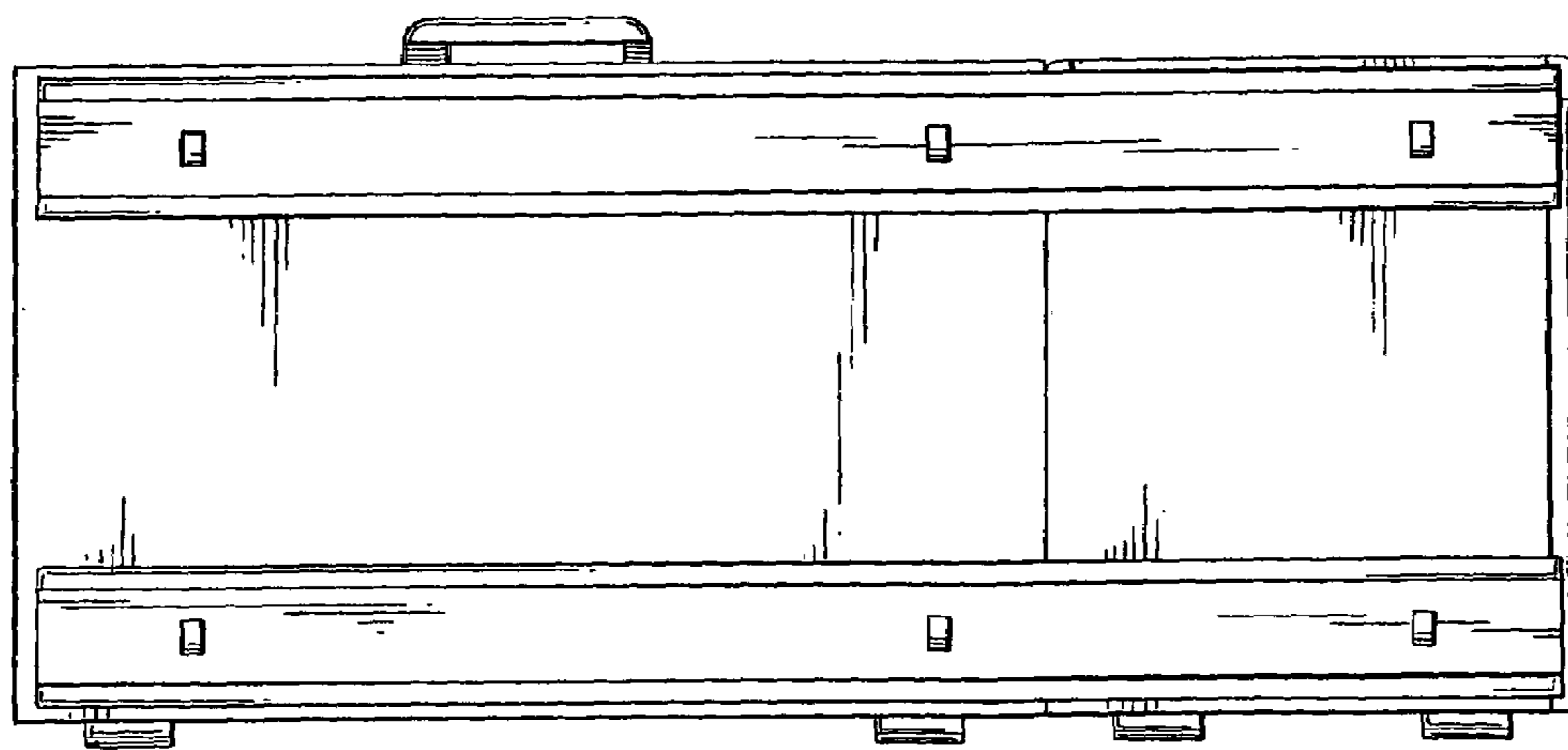

Fig. 5

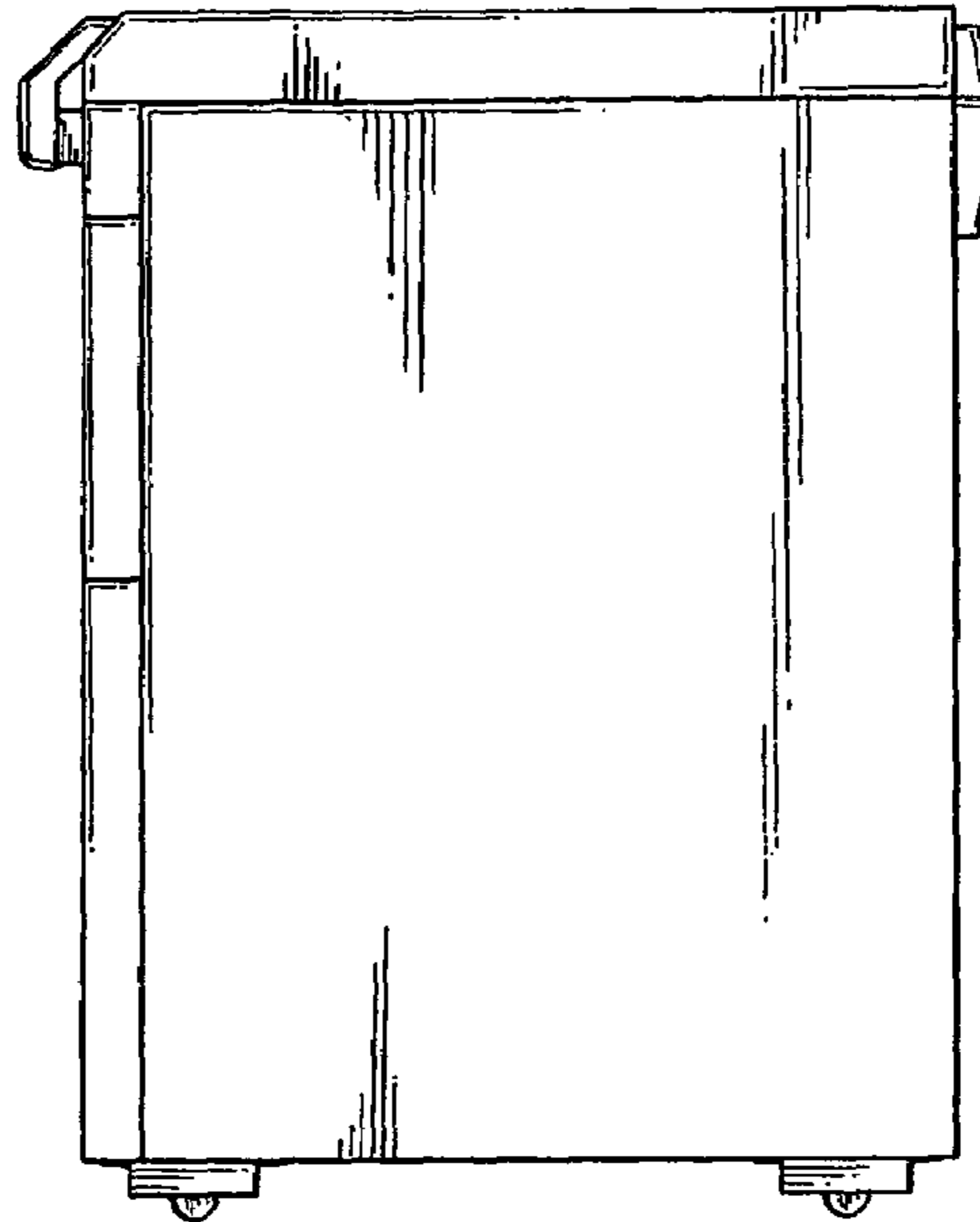

Fig. 6

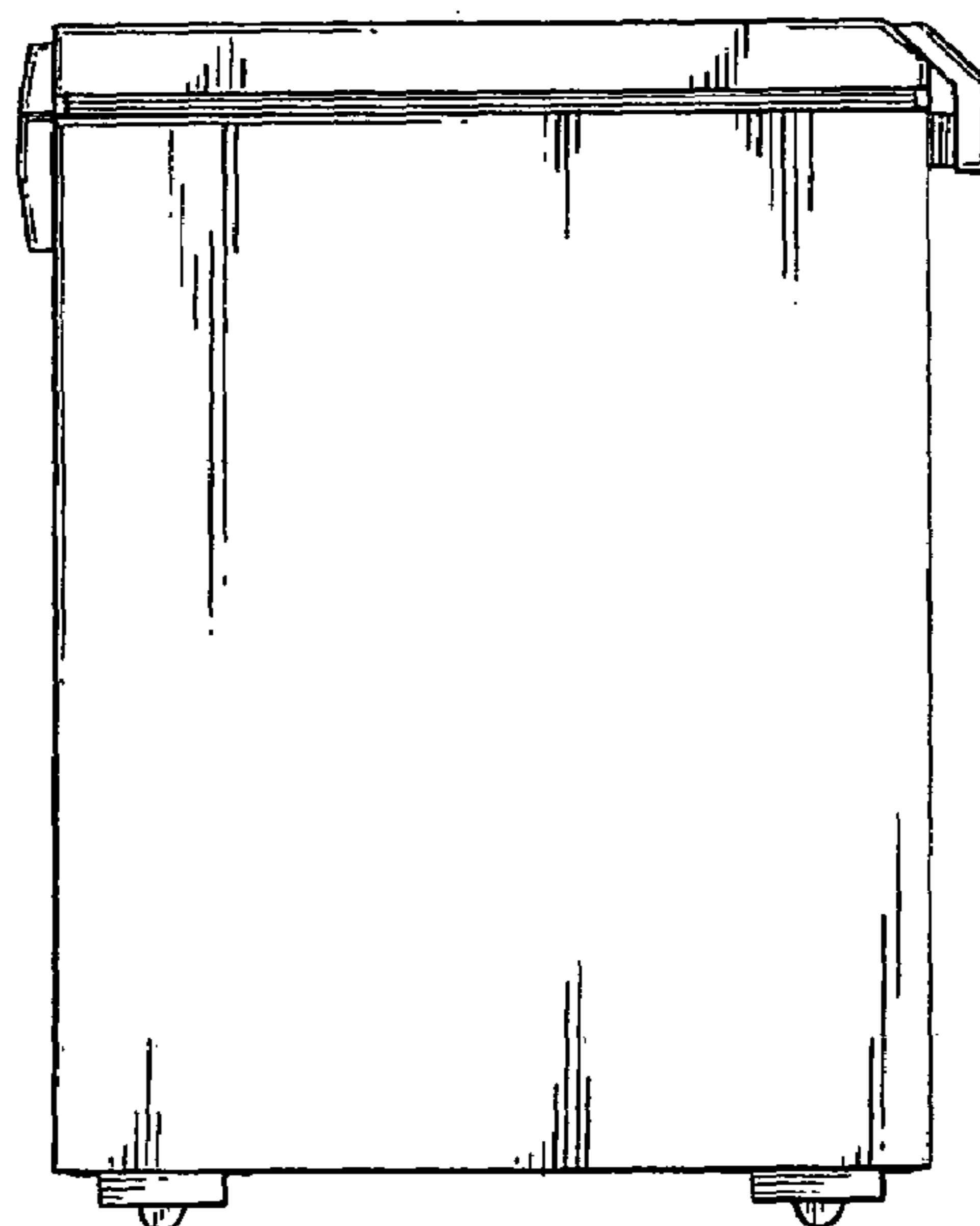

Fig. 7

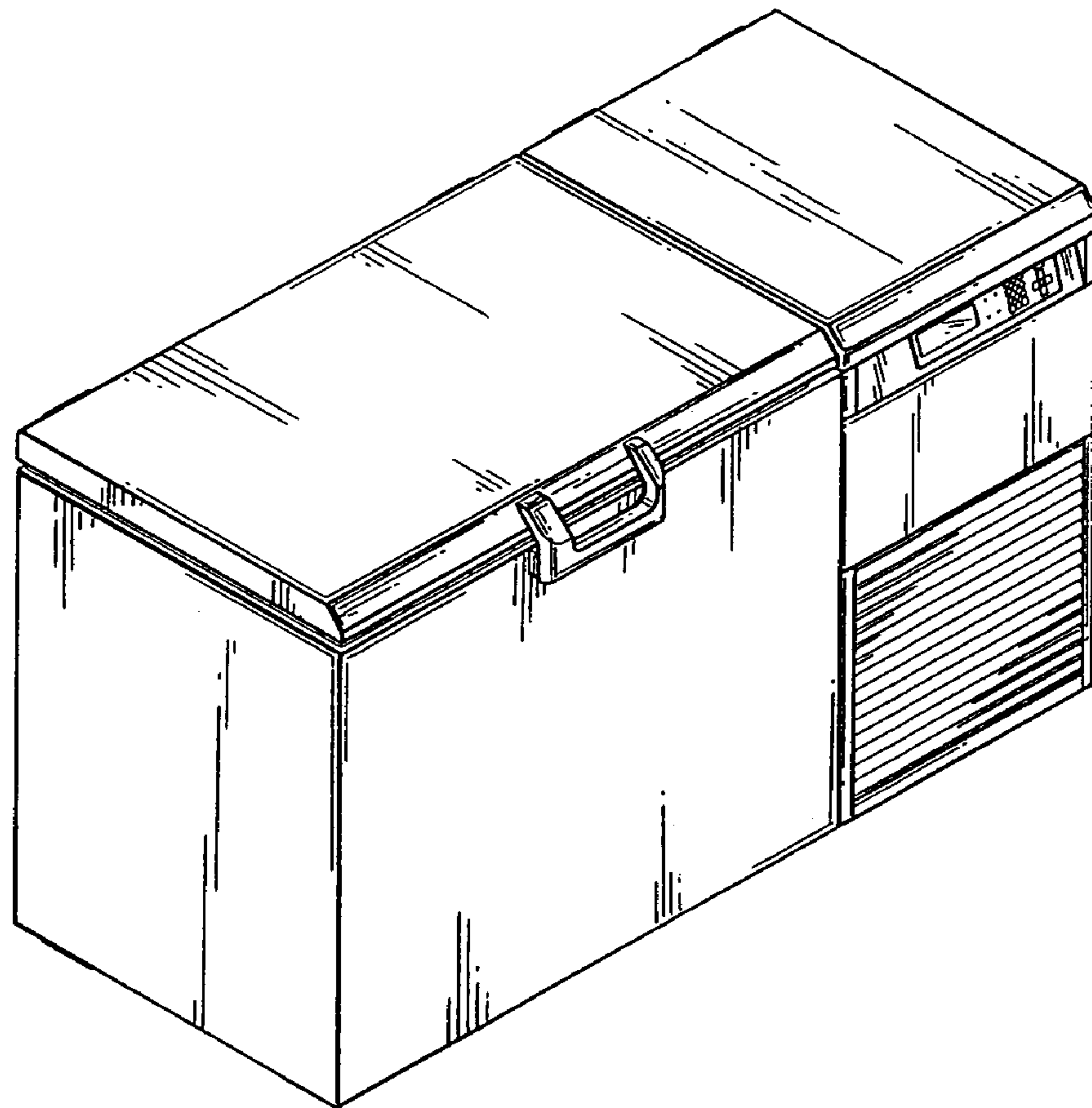

Fig. 8

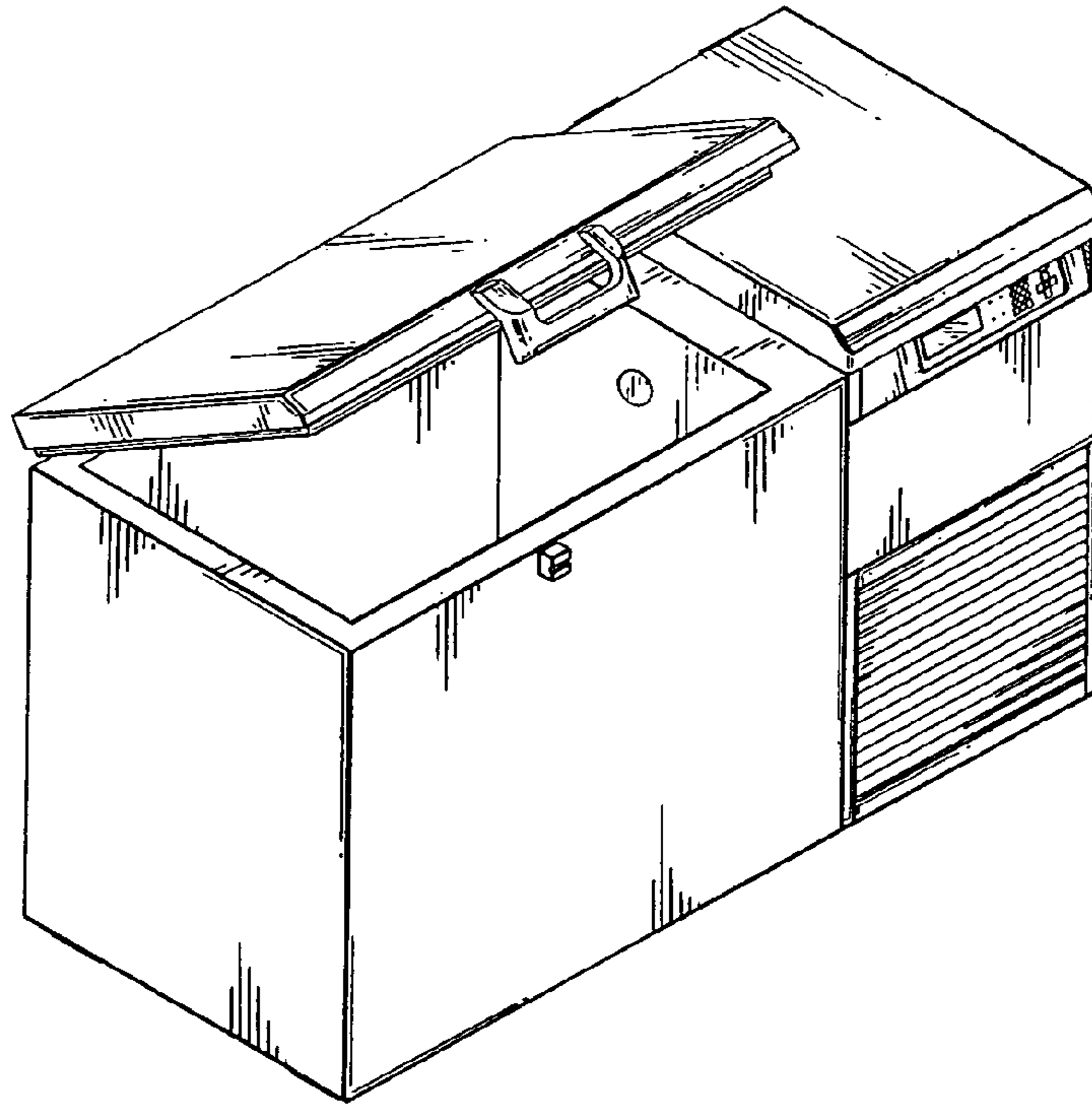

Fig. 9

