



US00D548104S

(12) **United States Design Patent**  
**Waldner**

(10) **Patent No.:** **US D548,104 S**

(45) **Date of Patent:** **\*\* Aug. 7, 2007**

(54) **CONTAINER**

(75) Inventor: **Thomas Waldner**, Malmo (SE)

(73) Assignee: **Tetra Laval Holdings & Finance S.A.**,  
Pully (CH)

(\*\*) Term: **14 Years**

(21) Appl. No.: **29/263,891**

(22) Filed: **Aug. 1, 2006**

**Related U.S. Application Data**

(62) Division of application No. 29/210,858, filed on Aug. 9, 2004, now Pat. No. Des. 537,346.

(51) **LOC (8) Cl.** ..... **09-01**

(52) **U.S. Cl.** ..... **D9/571**

(58) **Field of Classification Search** ..... D9/417,  
D9/430-431, 433, 510, 512, 514, 516-517,  
D9/547, 560, 563-564, 568, 571-574; 215/379,  
215/381-385, 393, 395; 220/677, 678  
See application file for complete search history.

(56) **References Cited**

**U.S. PATENT DOCUMENTS**

D103,049 S *	2/1937	Higgins	.....	D9/574
D274,221 S *	6/1984	Biesecker	.....	D9/503
D276,889 S *	12/1984	Biesecker	.....	D9/500
D282,910 S *	3/1986	Biesecker	.....	D9/560
D447,941 S *	9/2001	Quensel et al.	.....	D9/417
D448,286 S *	9/2001	Quensel et al.	.....	D9/417

D464,572 S *	10/2002	Markus	.....	D9/569
D475,929 S *	6/2003	Bakic	.....	D9/574
D480,966 S *	10/2003	Iwano	.....	D9/432
D483,267 S *	12/2003	Boldrini et al.	.....	D9/573
D489,265 S *	5/2004	Boldrini et al.	.....	D9/520
D489,989 S *	5/2004	Boldrini et al.	.....	D9/520
D535,189 S *	1/2007	Pitman et al.	.....	D9/452

\* cited by examiner

*Primary Examiner*—Ian Simmons

*Assistant Examiner*—Dana Sipos

(74) *Attorney, Agent, or Firm*—Buchanan Ingersoll & Rooney PC

(57) **CLAIM**

The ornamental design for a container, as shown and described.

**DESCRIPTION**

FIG. 1 is a front elevational view of a container showing my new design.

FIG. 2 is a rear elevational view thereof.

FIG. 3 is a right side elevational view thereof

FIG. 4 is a left side elevational view thereof.

FIG. 5 is a top plan view thereof; and,

FIG. 6 is a bottom plan view thereof.

The broken lines shown in the drawings are for illustrative purposes only and form no part of the claimed design.

**1 Claim, 3 Drawing Sheets**

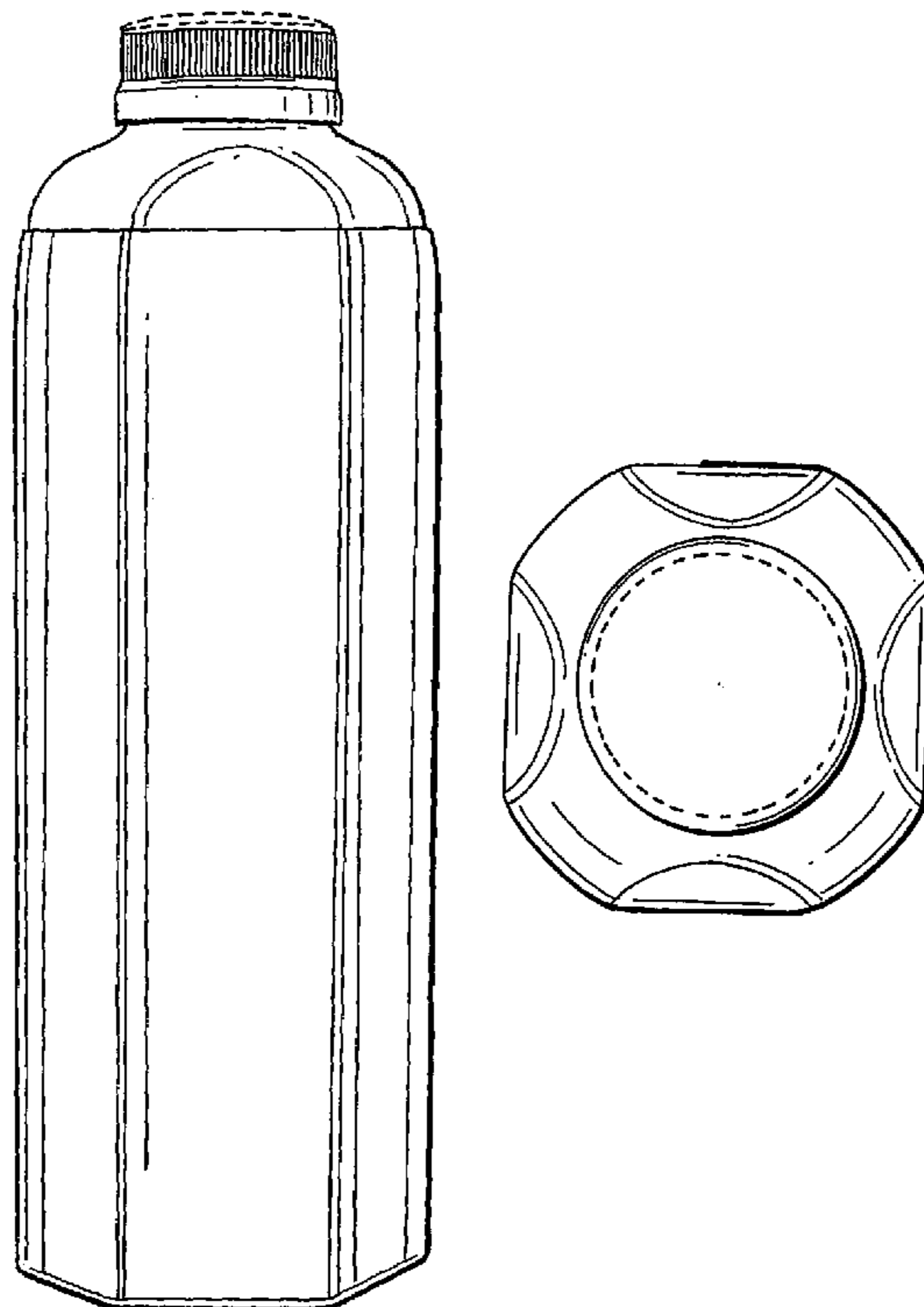

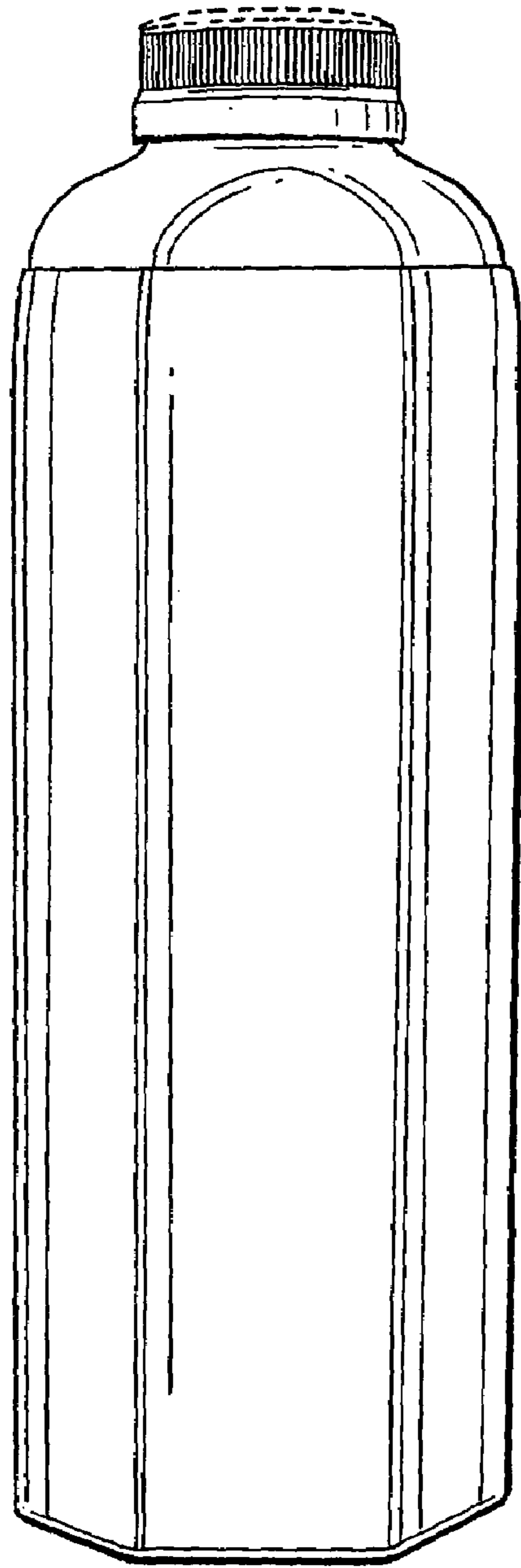

FIG. 1

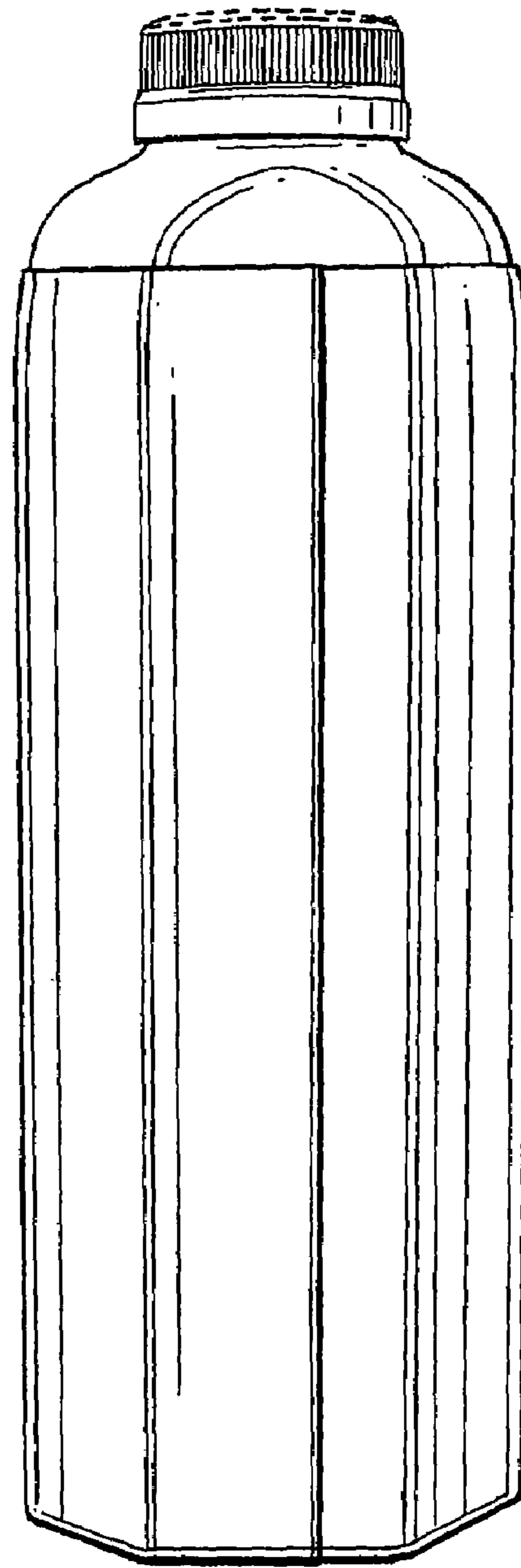

FIG. 2

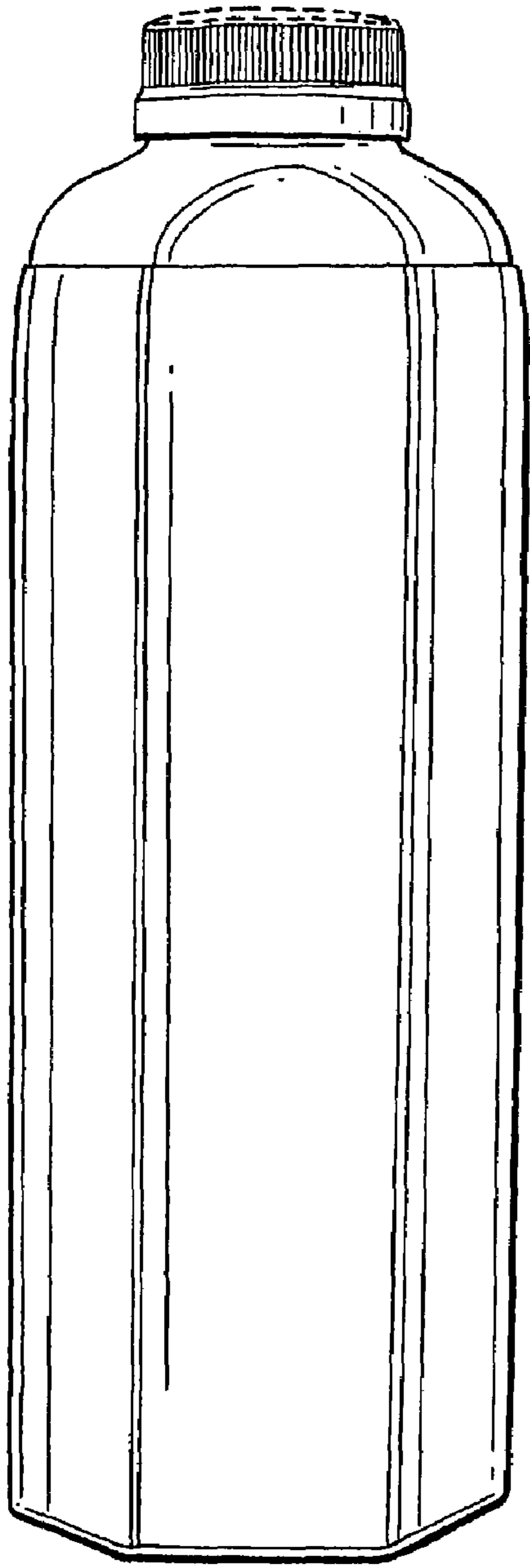

FIG. 3

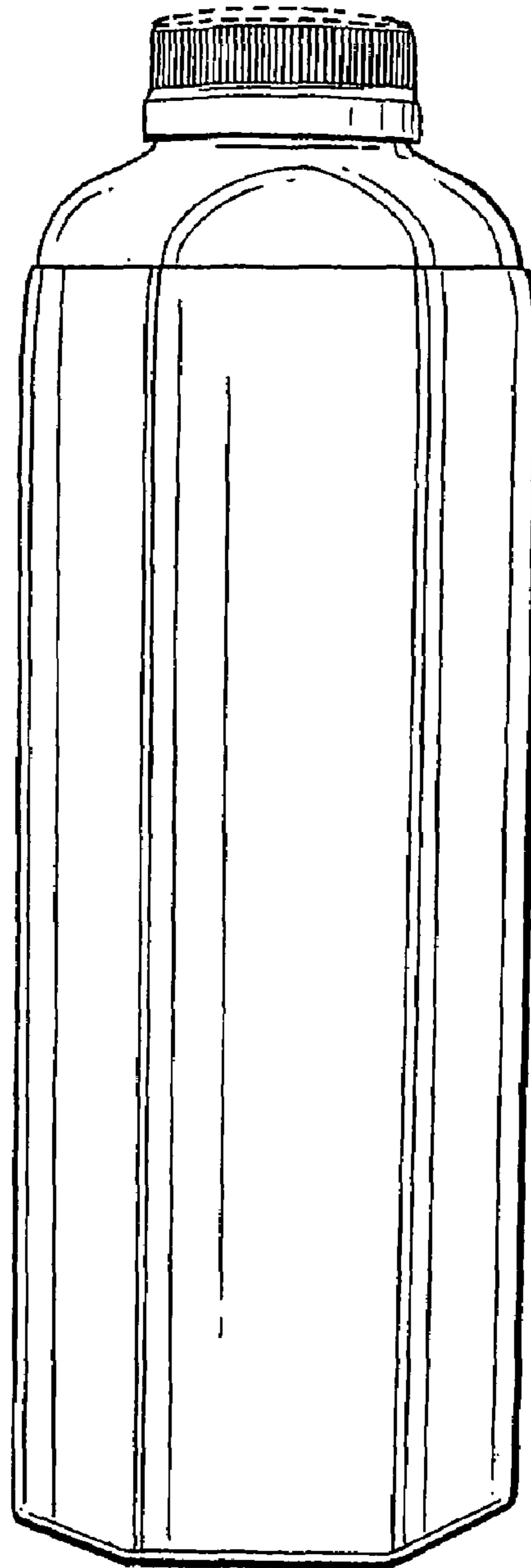

FIG. 4

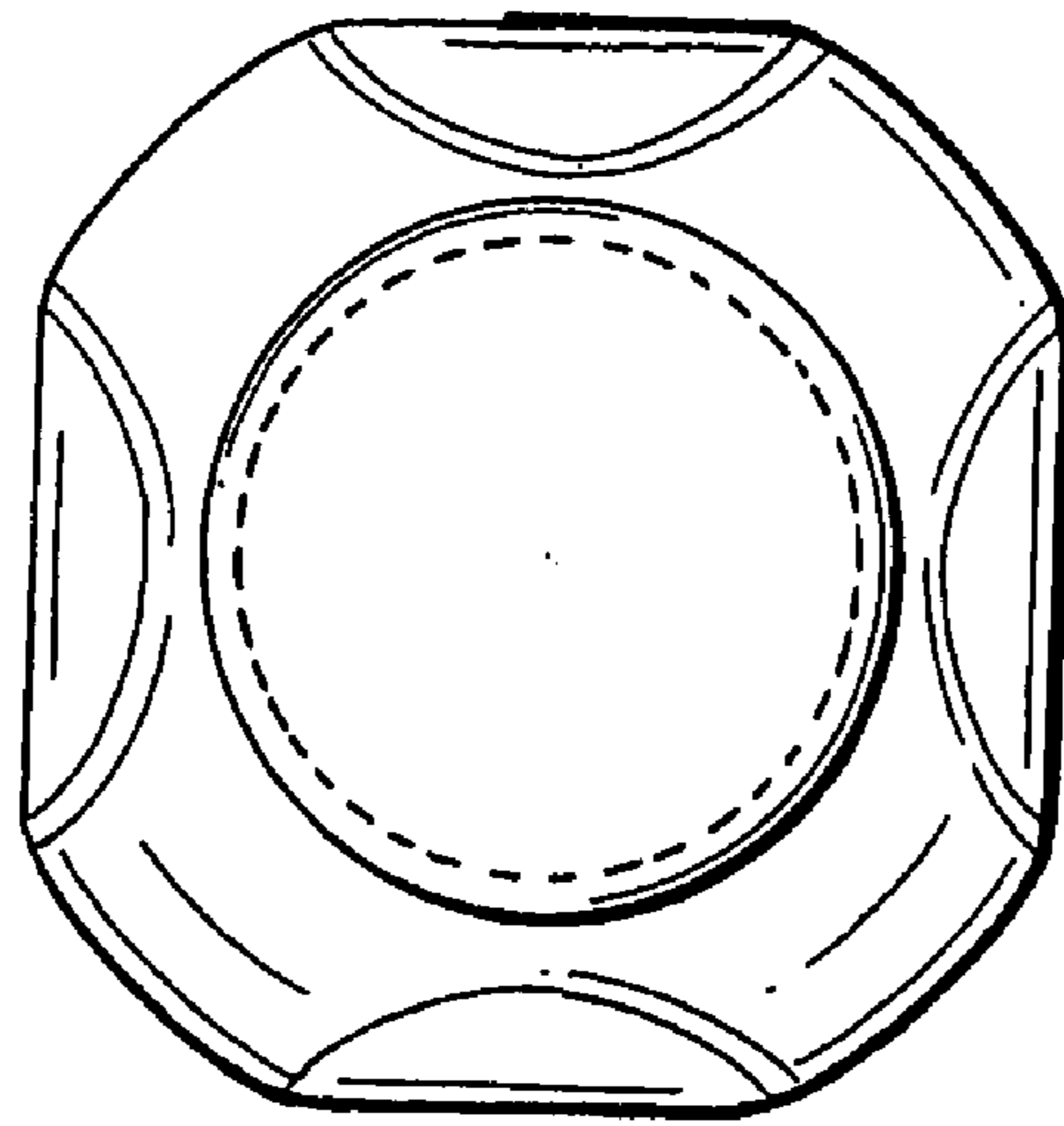

FIG. 5

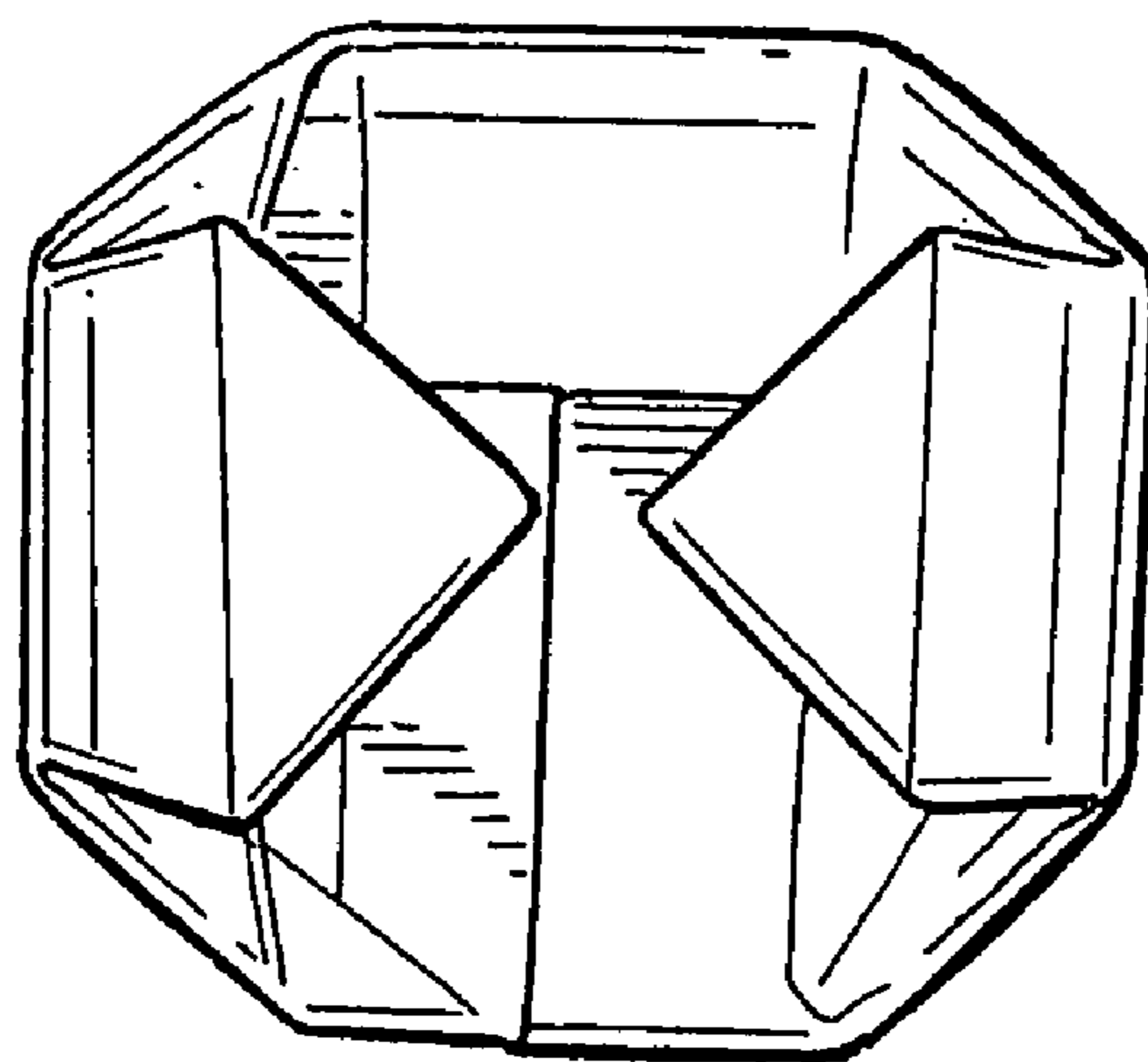

FIG. 6