



US00D548037S

(12) **United States Design Patent**
Ott et al.

(10) **Patent No.: US D548,037 S**

(45) **Date of Patent: ** Aug. 7, 2007**

(54) **FRONT PORTIONS OF AN OVAL HANDLE AND HOUSING ASSEMBLY WITH PIVOTAL COVER**

4,192,161 A 3/1980 Borlinghaus

(Continued)

(75) Inventors: **Brian M. Ott**, Huntley, IL (US);
Michael O. Misner, Lake Villa, IL (US)

Primary Examiner—Paula A. Greene
(74) *Attorney, Agent, or Firm*—David A. Burge

(73) Assignee: **The Eastern Company**, Wheeling, IL (US)

(57) **CLAIM**

(**) Term: **14 Years**

We claim the ornamental design for front portions of an oval handle and housing assembly with pivotal cover, as shown and described.

(21) Appl. No.: **29/243,279**

DESCRIPTION

(22) Filed: **Nov. 22, 2005**

(51) **LOC (8) Cl.** **08-06**

(52) **U.S. Cl.** **D8/302; D8/346**

(58) **Field of Classification Search** D8/300,
D8/302, 307, 344, 346, 331, 334, 336, 337,
D8/350, 352; 70/56, 423, 455, 419, 429,
70/372; 296/106

FIG. 1 is a perspective view of an oval handle and housing assembly with pivotal cover showing our new design;

FIG. 2 is a perspective view thereof showing bottom, left and front features thereof;

FIG. 3 is a front view thereof;

FIG. 4 is a right side view thereof, it being understood that a left side view is identical hereto but a mirror image reversal hereof;

FIG. 5 is a top view thereof;

FIG. 6 is a bottom view thereof;

FIG. 7 is a perspective view of an oval handle and housing assembly with pivotal cover in an alternate position;

FIG. 8 is a right side view thereof, it being understood that a left side view is identical hereto but a mirror image reversal hereof;

FIG. 9 is a top view thereof;

FIG. 10 is a bottom view thereof;

FIG. 11 is a perspective view of an oval handle and housing assembly with pivotal cover in an alternate position;

FIG. 12 is a right side view thereof;

FIG. 13 is a left side view thereof;

FIG. 14 is a top view thereof; and,

FIG. 15 is a bottom view thereof.

See application file for complete search history.

(56) **References Cited**

U.S. PATENT DOCUMENTS

1,648,251 A *	11/1927	Zygmunt	70/455
1,982,956 A *	12/1934	Jacobi	70/455
2,213,814 A	9/1940	Jacobi	
2,303,594 A	12/1942	Wise	
2,343,605 A	3/1944	Wise	
2,355,300 A	8/1944	Johnstone	
2,388,228 A	10/1945	Johnstone	
2,391,498 A	12/1945	Wise	
2,400,229 A	5/1946	Freeman	
2,491,337 A *	12/1949	Segal	70/419
D156,767 S *	1/1950	Rochow	D8/346
2,562,038 A	7/1951	Jacobi	
2,602,319 A	7/1952	Jacobi	
2,702,468 A	2/1955	Spain	
2,931,209 A *	4/1960	Dies et al.	70/455
3,898,824 A	8/1975	Borlinghaus	
3,930,391 A	1/1976	Borlinghaus	
4,073,165 A	2/1978	Grundstrom et al.	

1 Claim, 8 Drawing Sheets

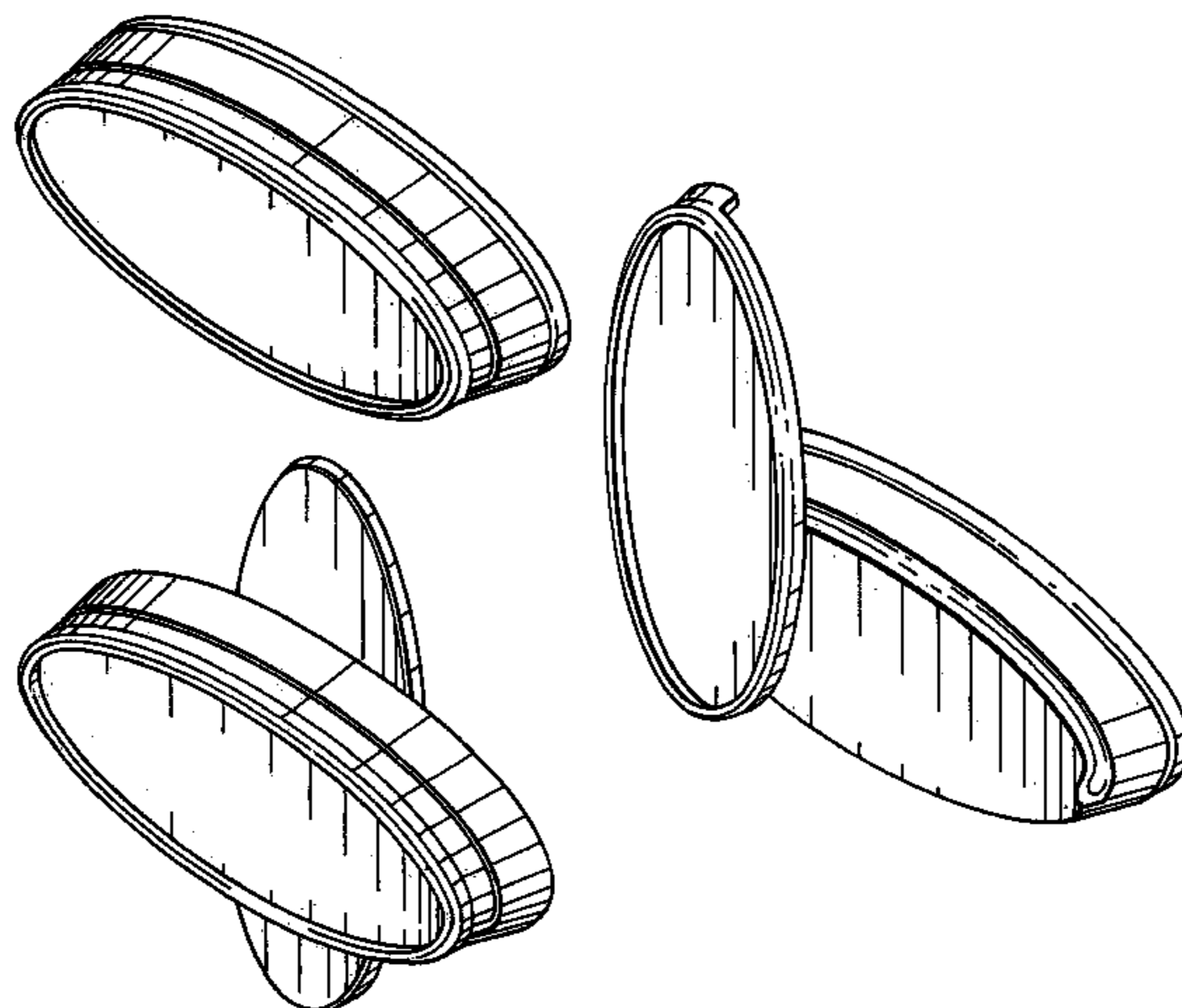

US D548,037 S

Page 2

U.S. PATENT DOCUMENTS						
			D391,139	S	*	2/1998 Gilliam D8/331
4,597,274	A	7/1986 Coscia et al.	5,718,137	A	2/1998 Huston	
4,655,059	A	4/1987 Best et al.	5,758,529	A	*	6/1998 Chhatwal 70/423
4,674,308	A	6/1987 Peters	D397,026	S	*	8/1998 Drake D8/346
4,709,567	A	* 12/1987 Appelbaum 70/455	5,794,472	A	8/1998 Kester et al.	
4,723,428	A	2/1988 Yamaguchi	D433,306	S	*	11/2000 Pfeiffer D8/302
4,773,240	A	9/1988 Foshee	6,272,890	B1	8/2001 Huston	
4,773,242	A	9/1988 Smith	6,309,008	B1	10/2001 Bacon	
4,881,391	A	11/1989 Villa et al.	6,530,250	B1	3/2003 Linares et al.	
5,586,459	A	12/1996 Bullock et al.	6,640,593	B1	11/2003 Hannah et al.	
5,669,255	A	* 9/1997 Albano 70/56				

* cited by examiner

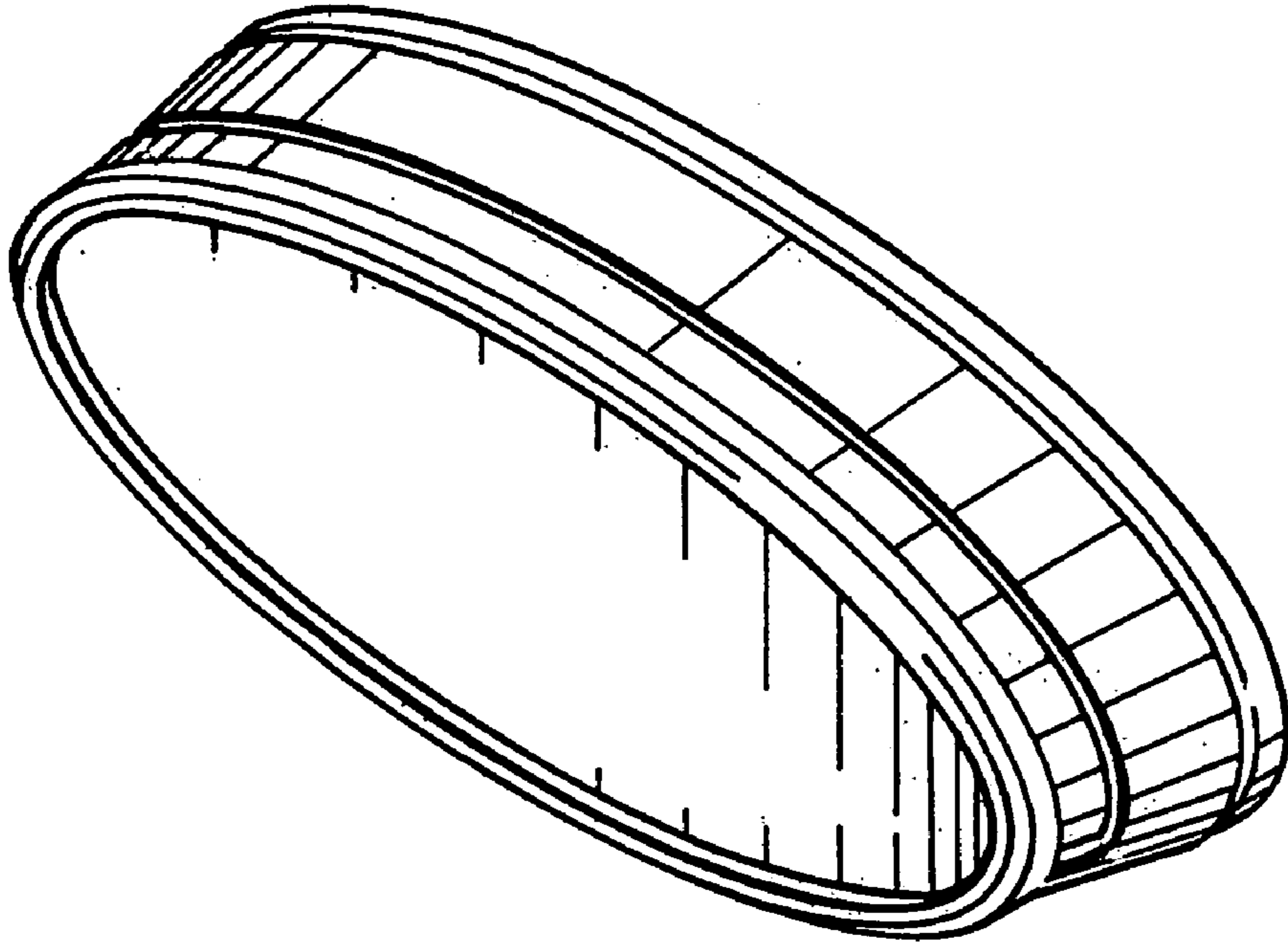

FIG. 1

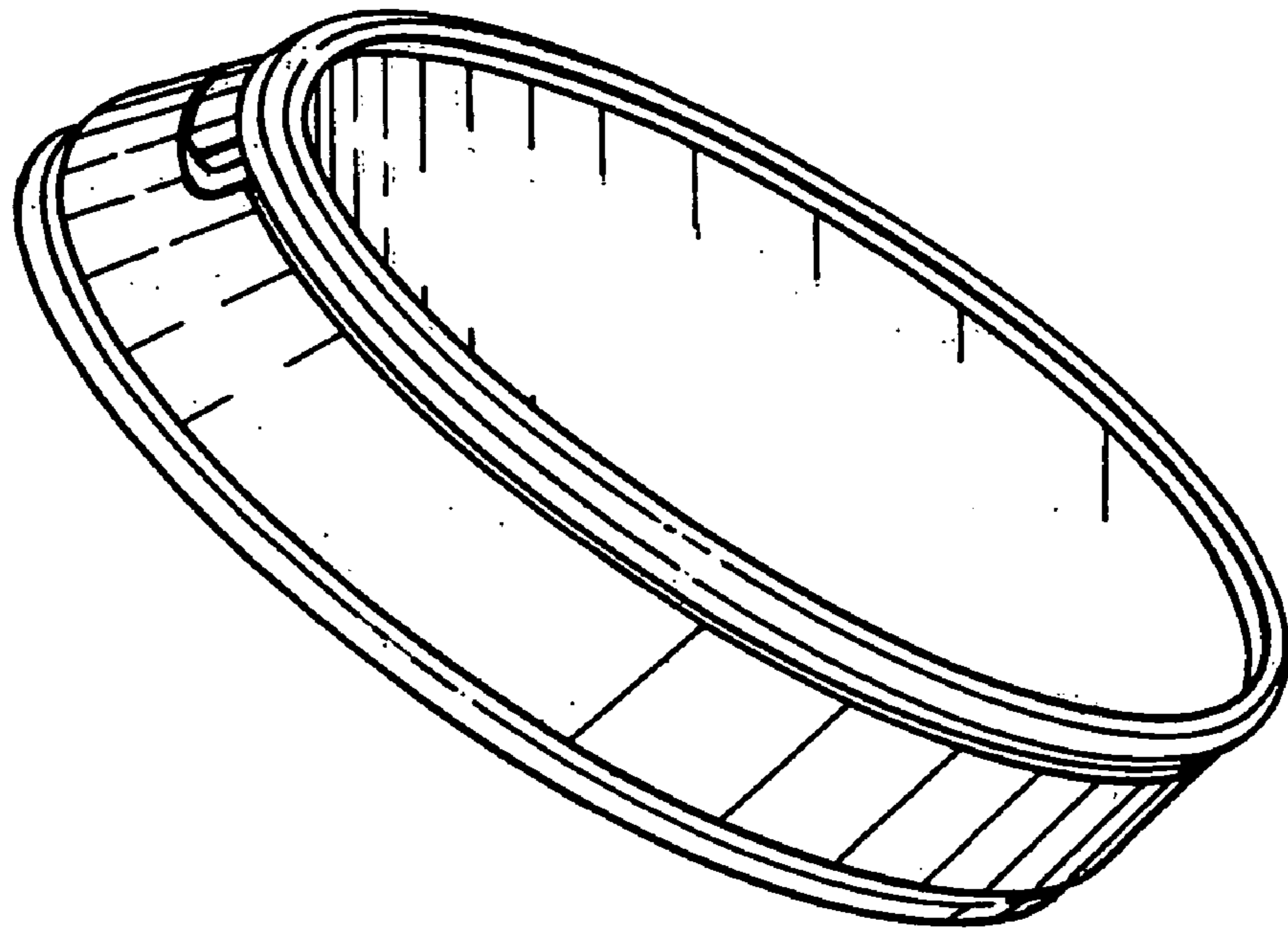

FIG. 2

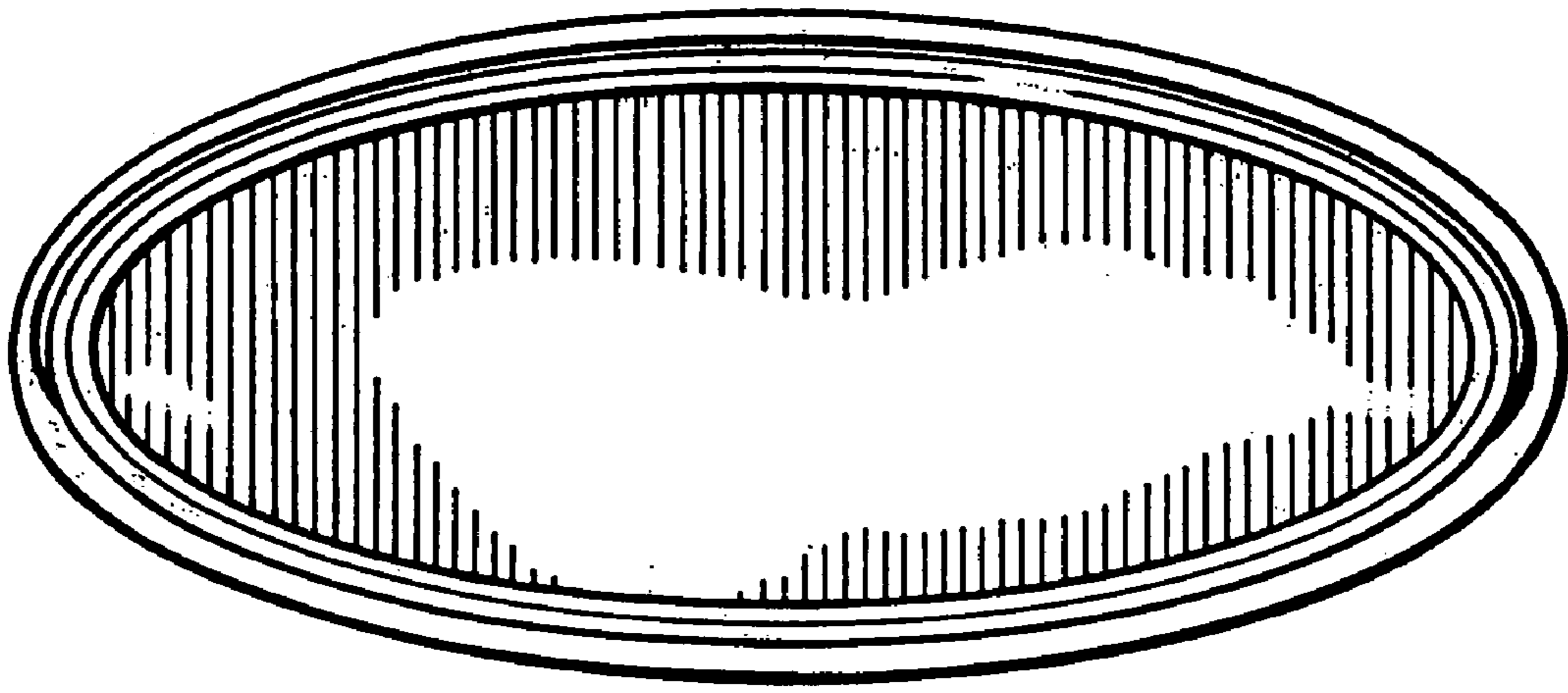

FIG. 3

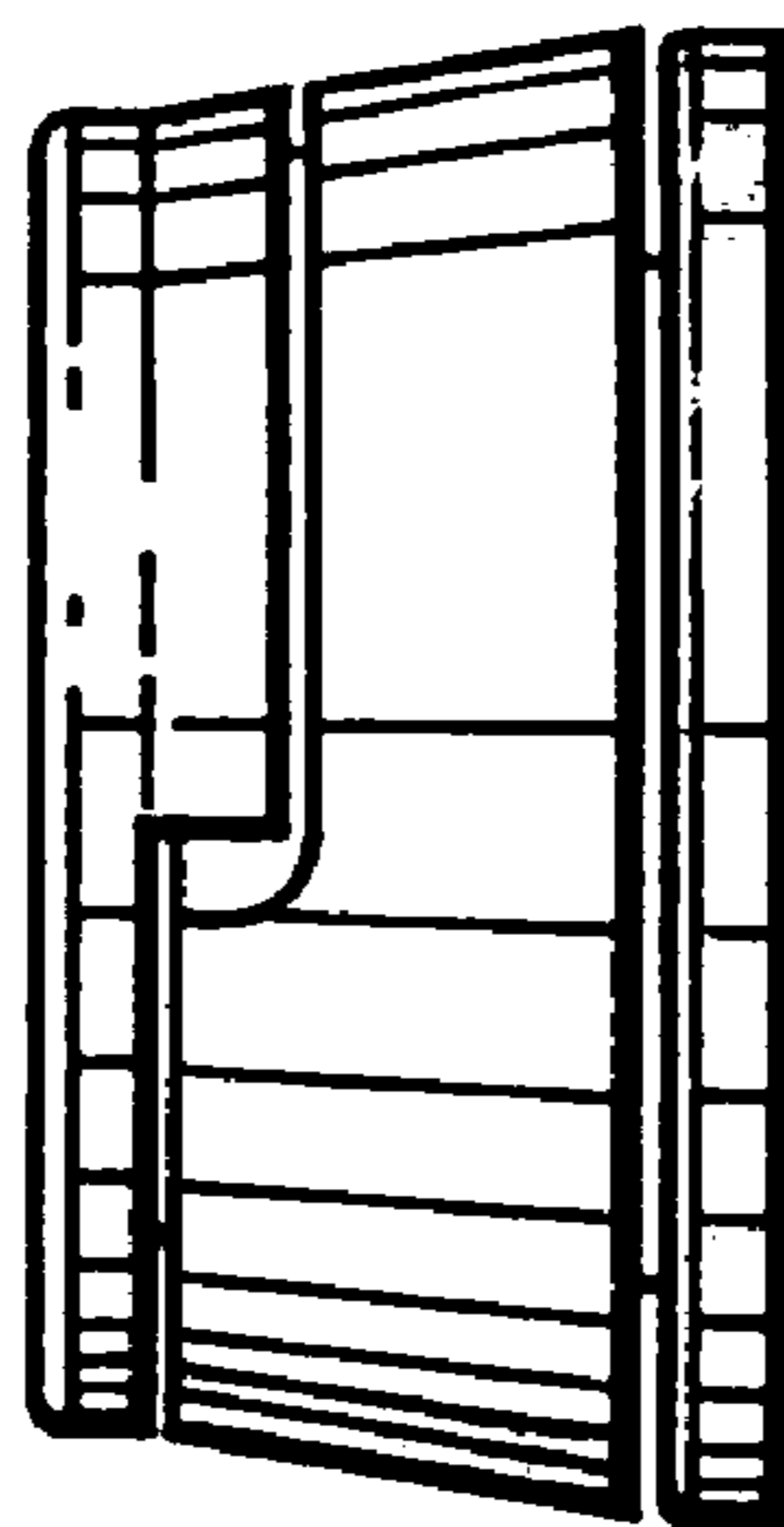

FIG. 4

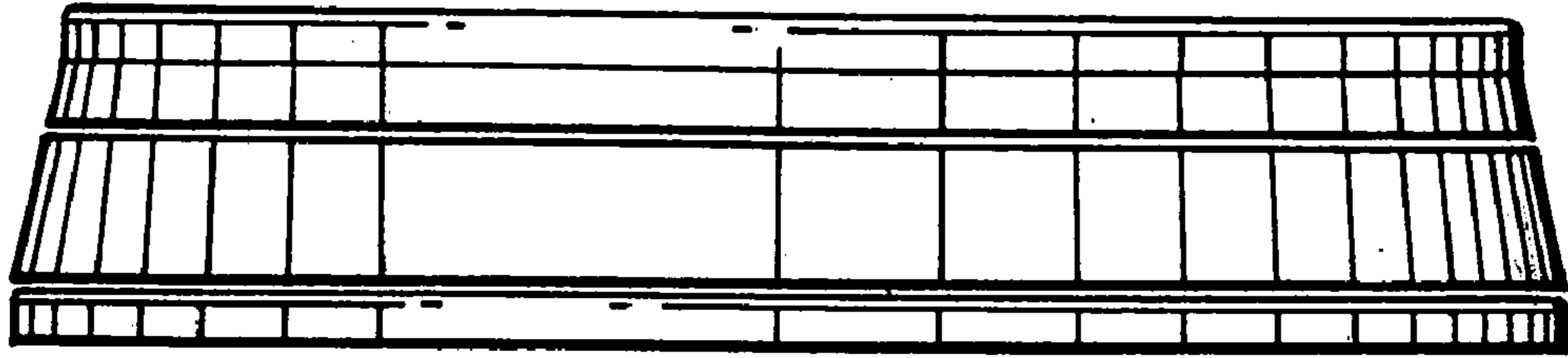

FIG. 5

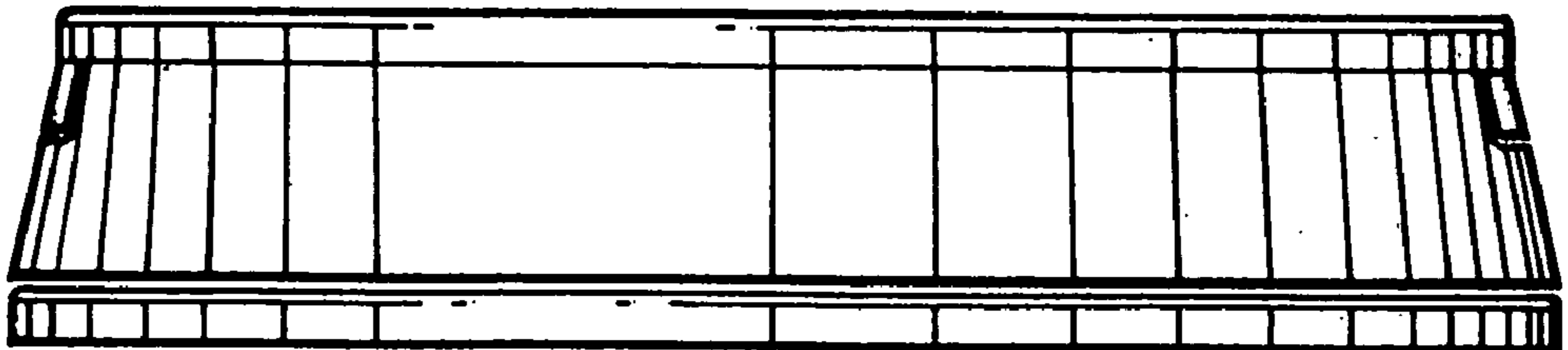

FIG. 6

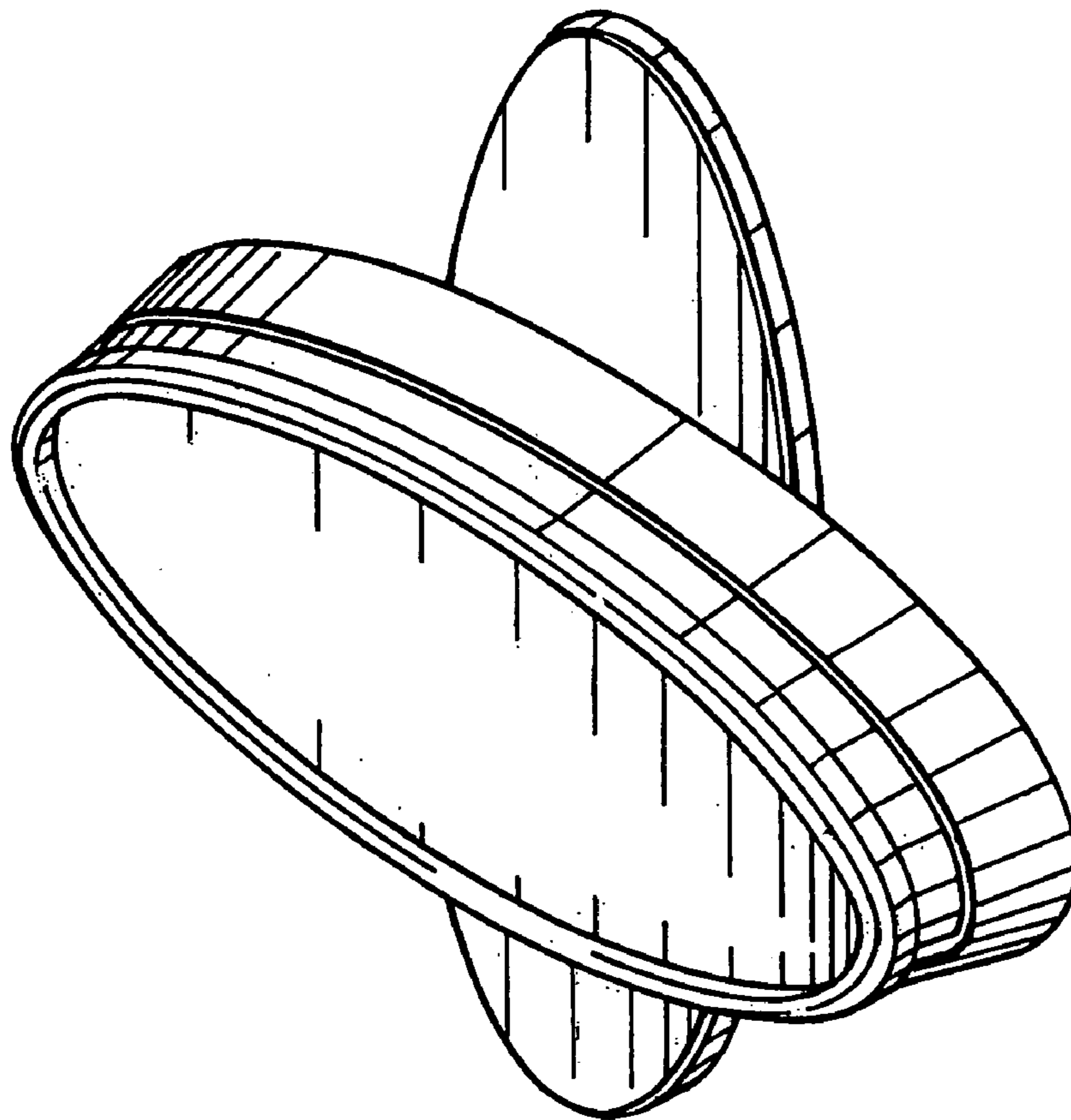

FIG. 7

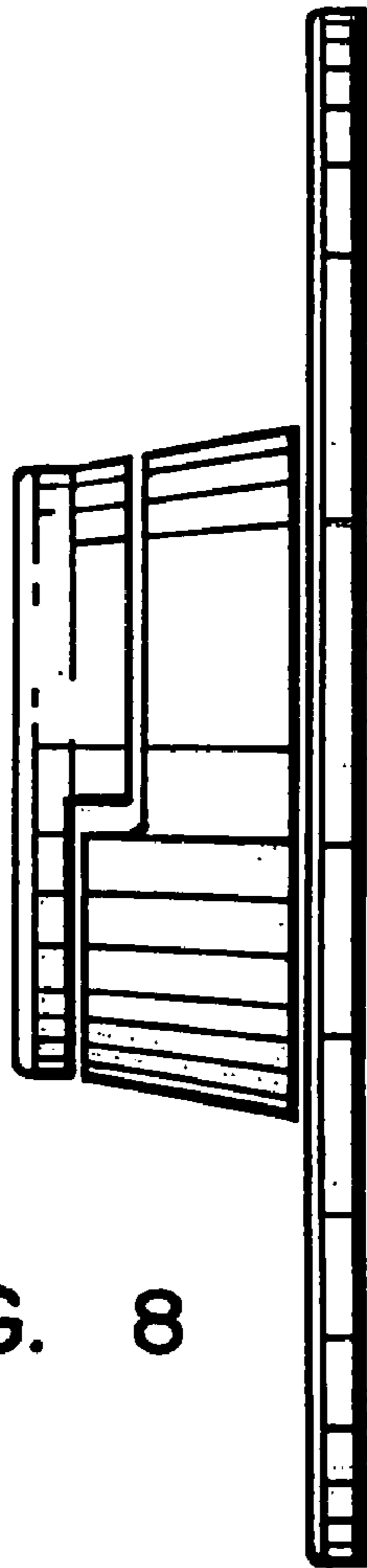

FIG. 8

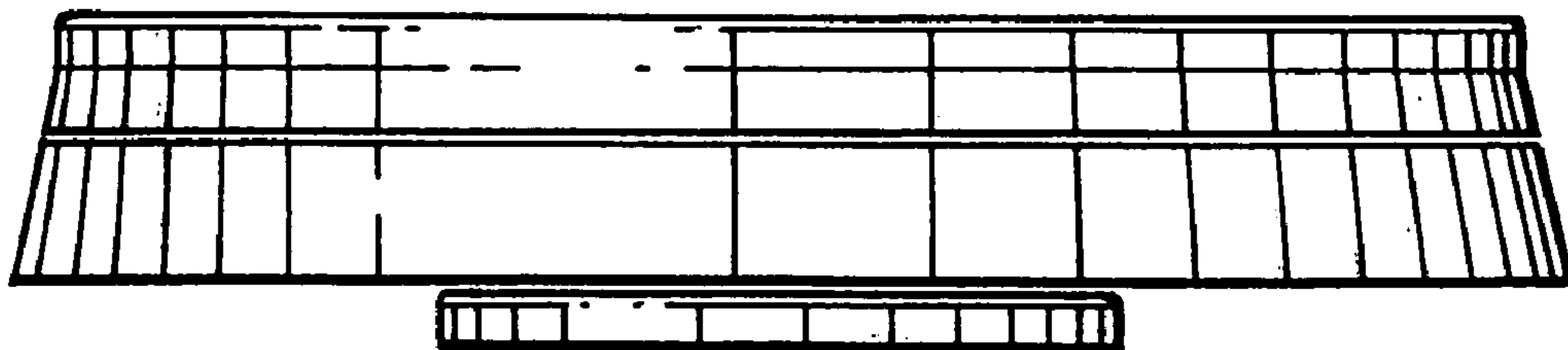

FIG. 9

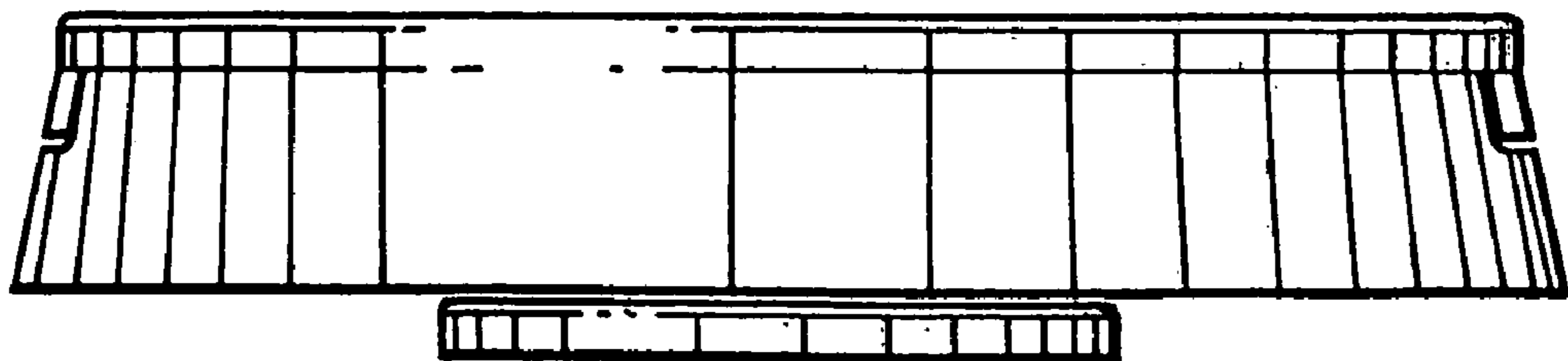

FIG. 10

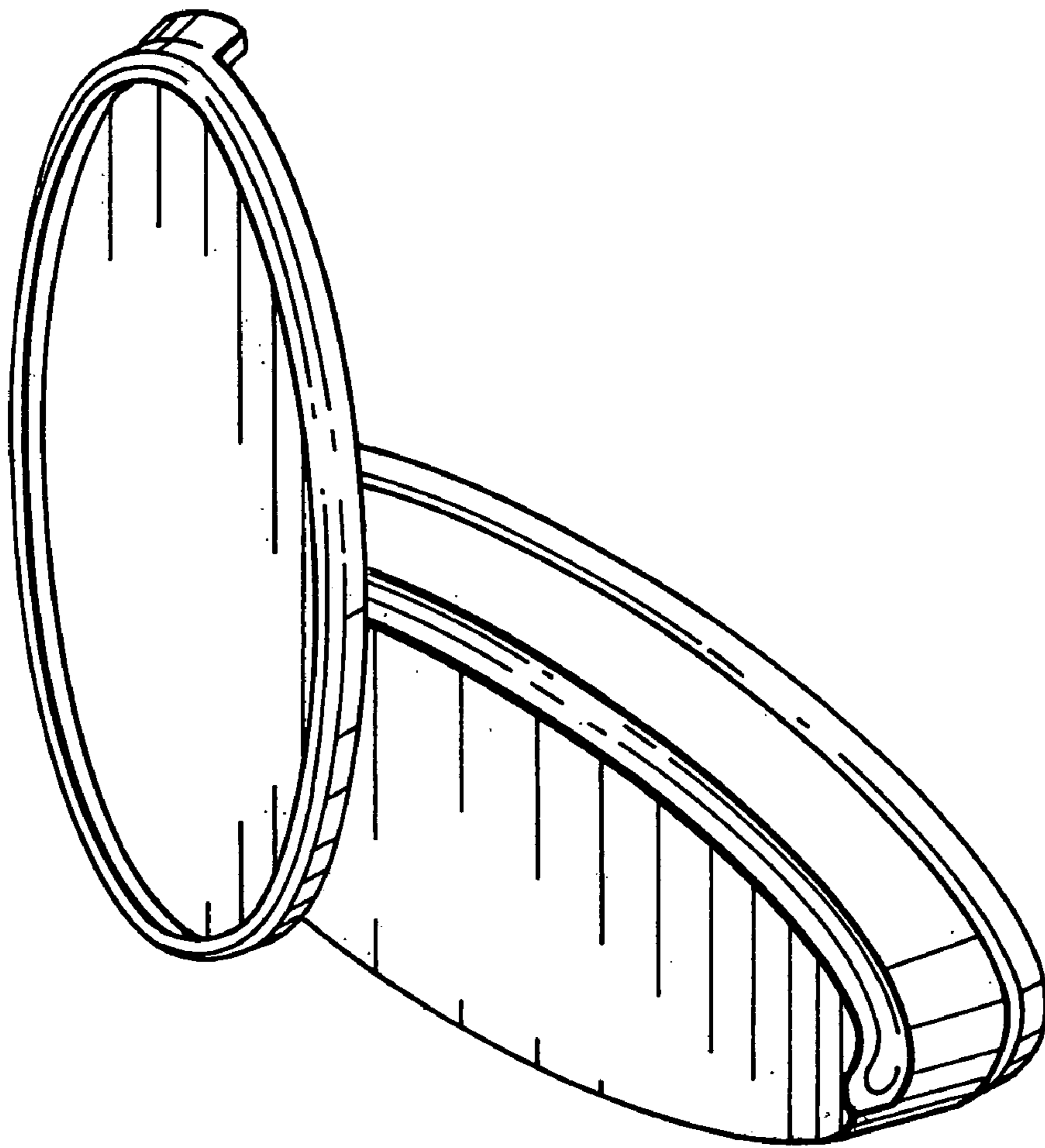

FIG. II

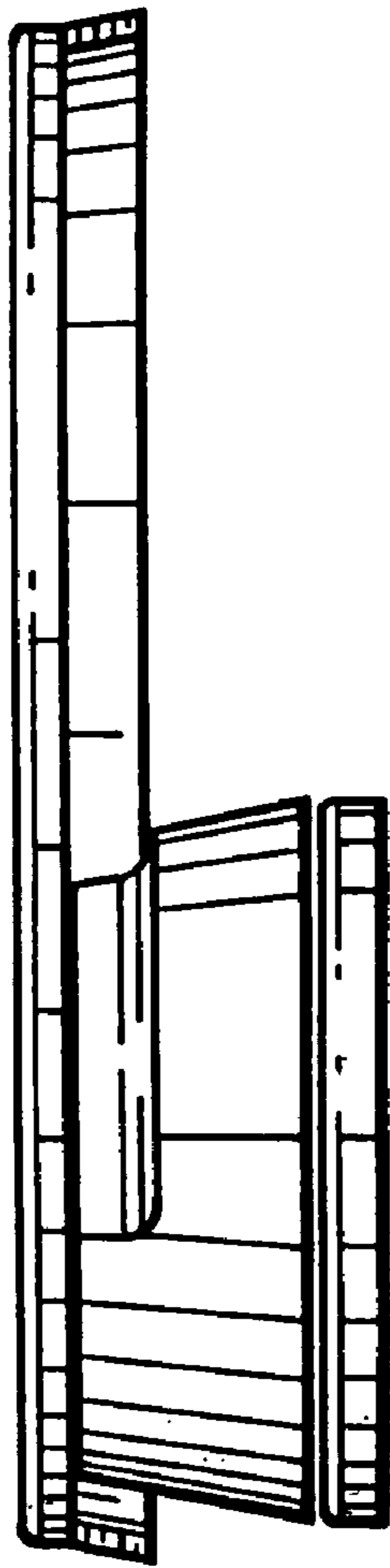

FIG. 12

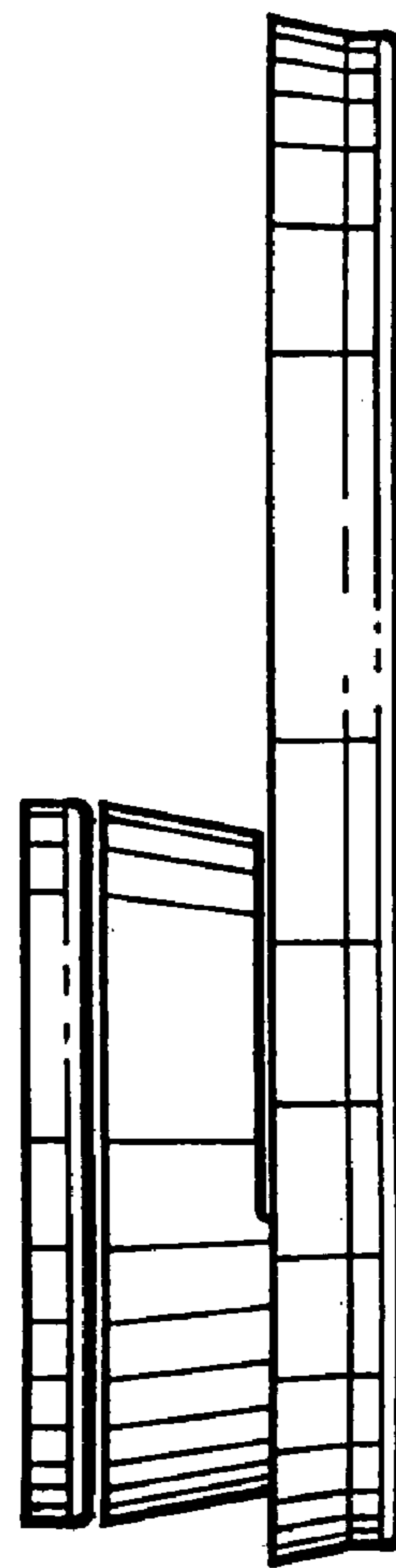

FIG. 13

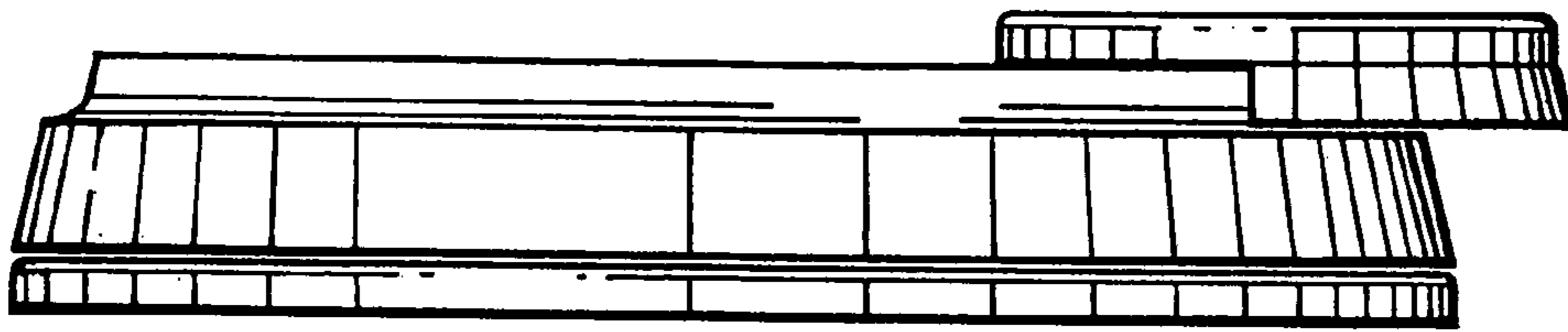

FIG. 14

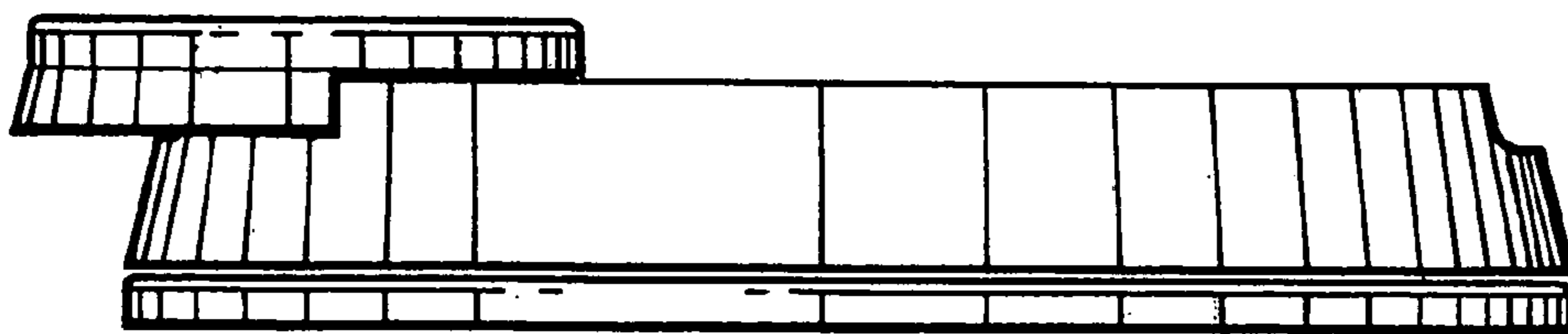

FIG. 15