



US00D548027S

(12) **United States Design Patent**  
**Demar et al.**

(10) **Patent No.:** **US D548,027 S**  
(45) **Date of Patent:** **\*\* Aug. 7, 2007**

(54) **HAND PRUNER**

(57) **CLAIM**

(76) Inventors: **David Demar**, 9 Byrne La., Tenafly, NJ (US) 07670; **Thomas VanDyk**, 369 Wyckoff Ave., Ramsey, NJ (US) 07446; **Roland Charriez**, 1681 Horton Rd., Mohegan Lake, NY (US) 10547; **Michael Ballone**, 51 Holmes Oval N., New Providence, NJ (US) 07974; **John Kiely**, 12 Hawthorne Ave., Morris Plains, NJ (US) 07950; **Keith Kristiansen**, 76 Plymouth St., Stratford, CT (US) 06614; **Melissa Fisher**, 1766 Coventry Rd., Columbus, OH (US) 43212; **Brian J. Conaway**, 1827 King Ave., Columbus, OH (US) 43212; **Mandi Reese**, 6509 Ganton Pl., Westerville, OH (US) 43082; **Terry M. Birchler**, 1618 Harrison Pond Dr., New Albany, OH (US) 43054; **Mark C. Eyman**, 2208 Arlington Ave. #5, Columbus, OH (US) 43221

The ornamental design for a hand pruner, as shown and described.

**DESCRIPTION**

FIG. 1 is a perspective view of a hand pruner showing our new design with handles retracted;  
FIG. 2 is a left-side elevational view of the hand pruner of FIG. 1;  
FIG. 3 is a right-side elevational view of the hand pruner of FIGS. 1 and 2;  
FIG. 4 is a top plan view of the hand pruner of FIGS. 1 to 3;  
FIG. 5 is a bottom plan view of the hand pruner of FIGS. 1 to 4;  
FIG. 6 is a front elevational view of the hand pruner of FIGS. 1 to 5;  
FIG. 7 is a rear elevational view of the hand pruner of FIGS. 1 to 6;  
FIG. 8 is a perspective view of the hand pruner of FIGS. 1 to 7 with the handles extended;  
FIG. 9 is a left-side elevational view of the hand pruner of FIG. 8;  
FIG. 10 is a right-side elevational view of the hand pruner of FIGS. 8 and 9;  
FIG. 11 is a top plan view of the hand pruner of FIGS. 8 to 10;  
FIG. 12 is a bottom plan view of the hand pruner of FIGS. 8 to 11;  
FIG. 13 is a front elevational view of the hand pruner of FIGS. 8 to 12; and,  
FIG. 14 is a rear elevational view of the hand pruner of FIGS. 8 to 13.

(\*\*) Term: **14 Years**

(21) Appl. No.: **29/235,650**

(22) Filed: **Aug. 4, 2005**

(51) **LOC (8) Cl.** ..... **08-01**

(52) **U.S. Cl.** ..... **D8/5**

(58) **Field of Classification Search** ..... D8/4,  
D8/5, 57; 30/250, 260, 262

See application file for complete search history.

(56) **References Cited**

**U.S. PATENT DOCUMENTS**

3,357,287 A \* 12/1967 Wertepny ..... 81/322  
D275,645 S \* 9/1984 Ishida et al. .... D8/5

(Continued)

*Primary Examiner*—Holly H. Baynham  
*Assistant Examiner*—Sheryl Friedman

**1 Claim, 9 Drawing Sheets**

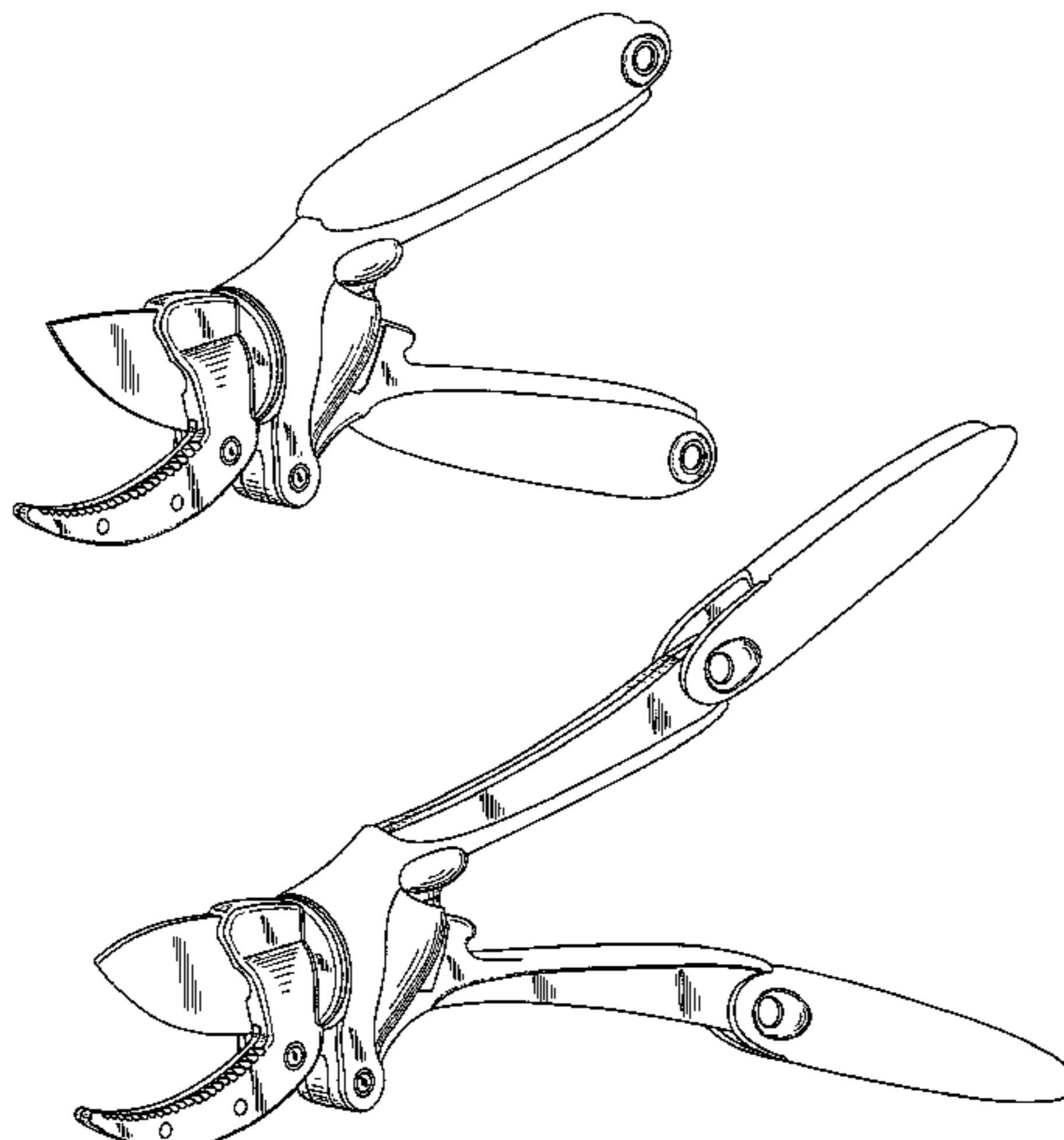

# US D548,027 S

Page 2

---

U.S. PATENT DOCUMENTS					
		6,523,266	B2 *	2/2003	Yang ..... 30/252
		D503,595	S *	4/2005	Lipscomb et al. .... D8/5
		2005/0241158	A1 *	11/2005	Demar et al. .... 30/341
D284,731	S *	7/1986	Linden	.....	D8/5
D413,052	S *	8/1999	Staton	.....	D8/5
D431,979	S *	10/2000	Deville	.....	D8/5
					* cited by examiner

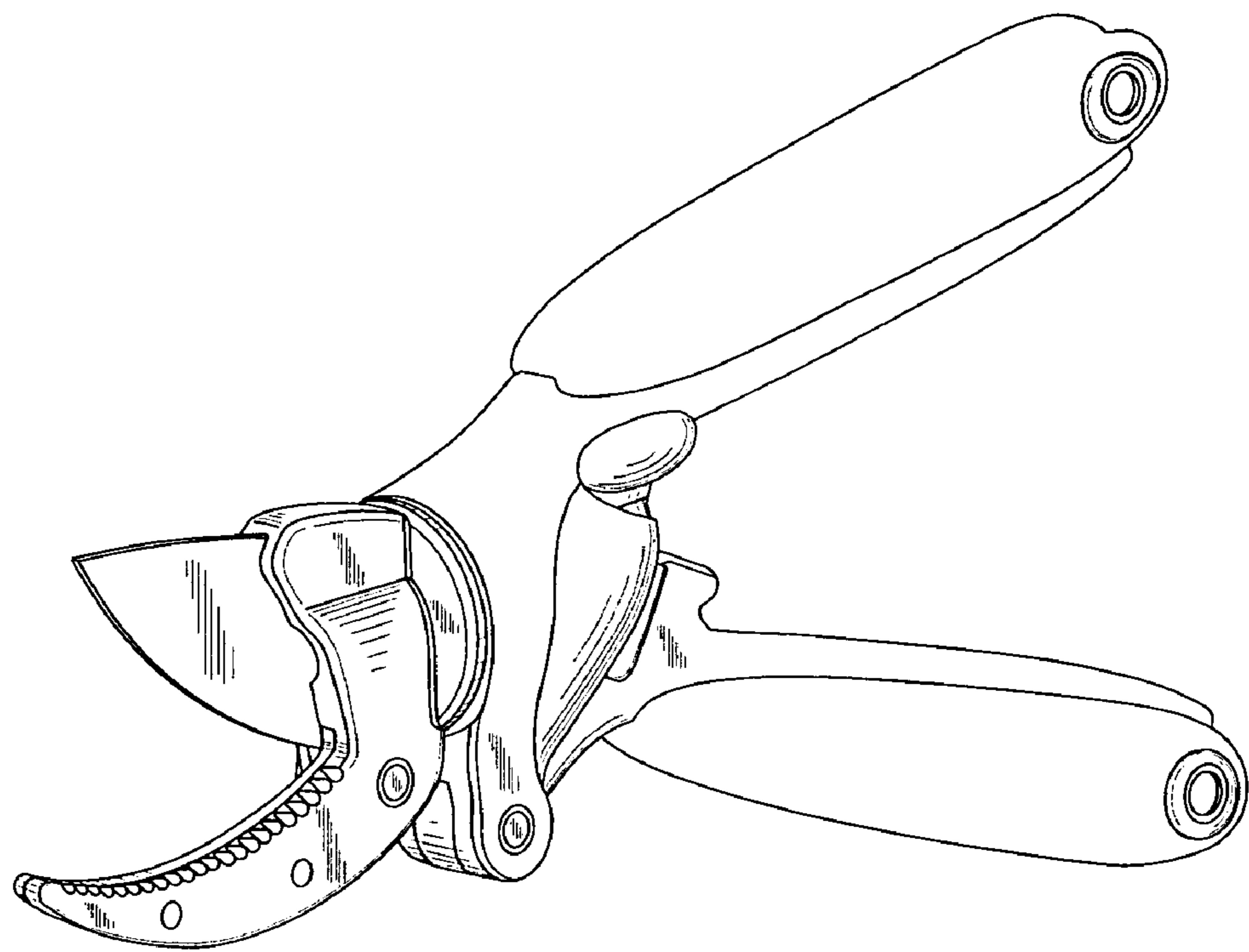

FIG. 1

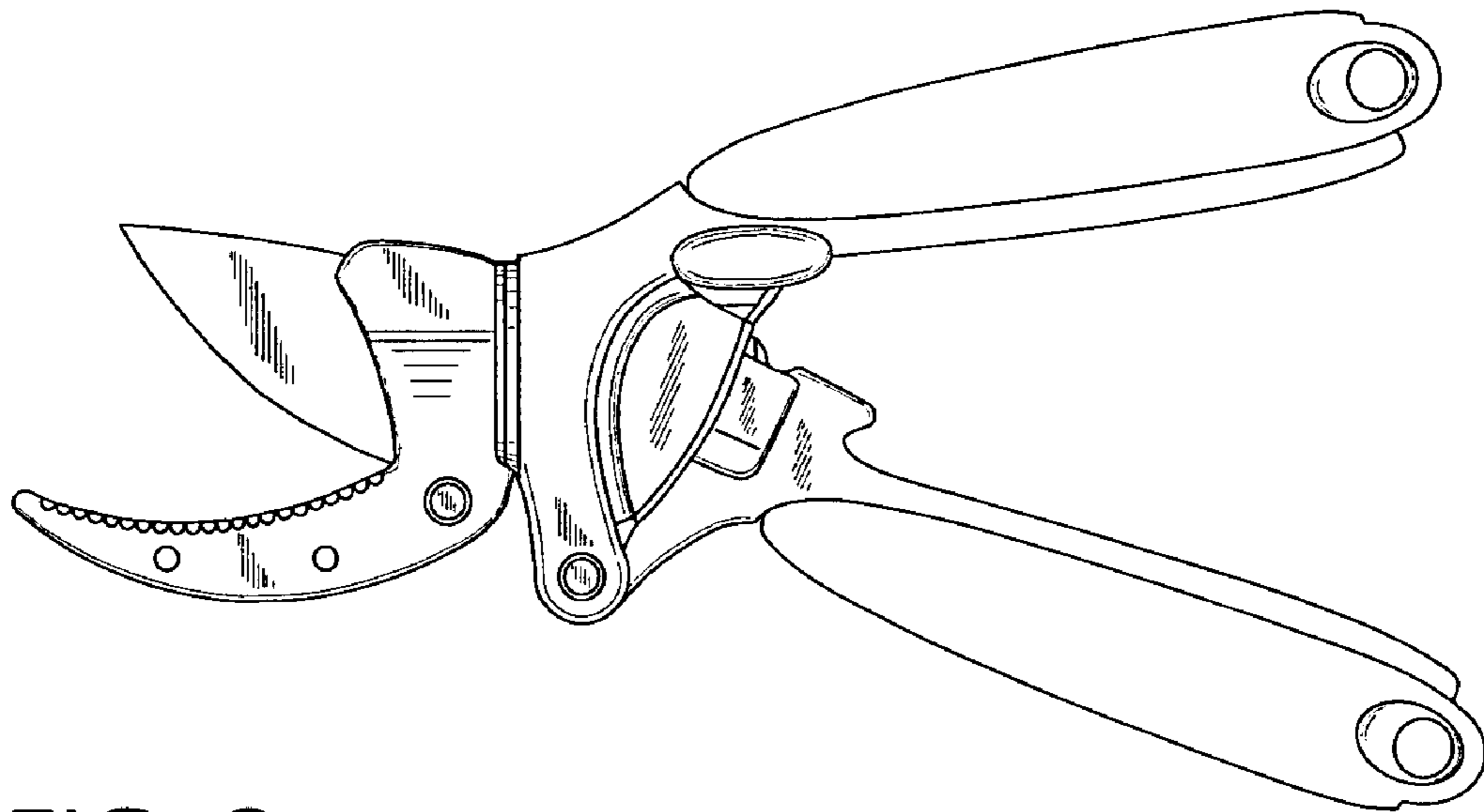

FIG. 2

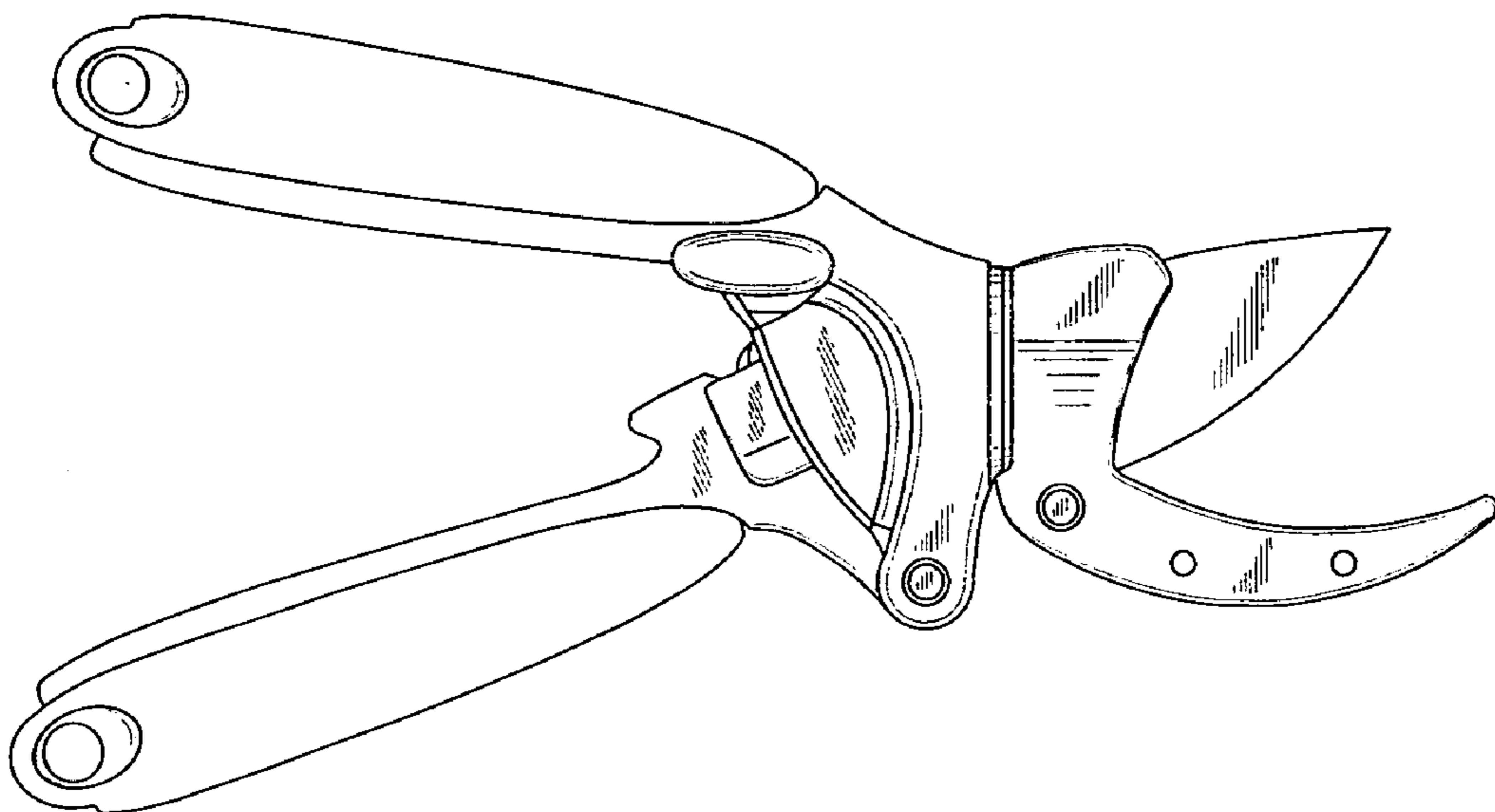

FIG. 3

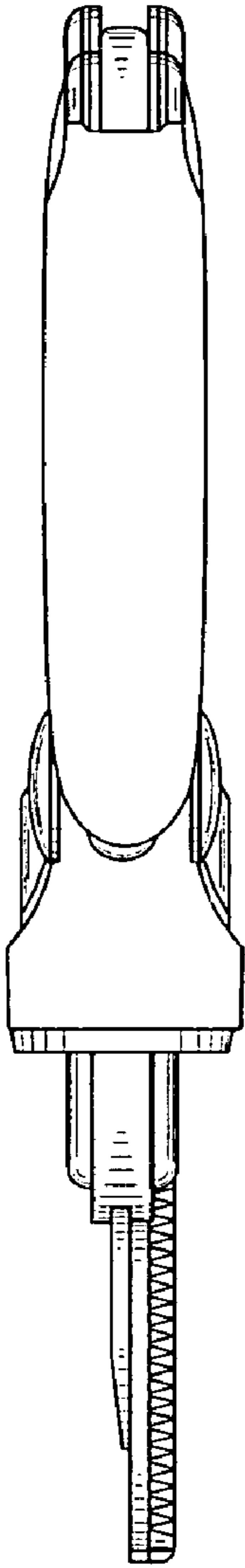

FIG. 4

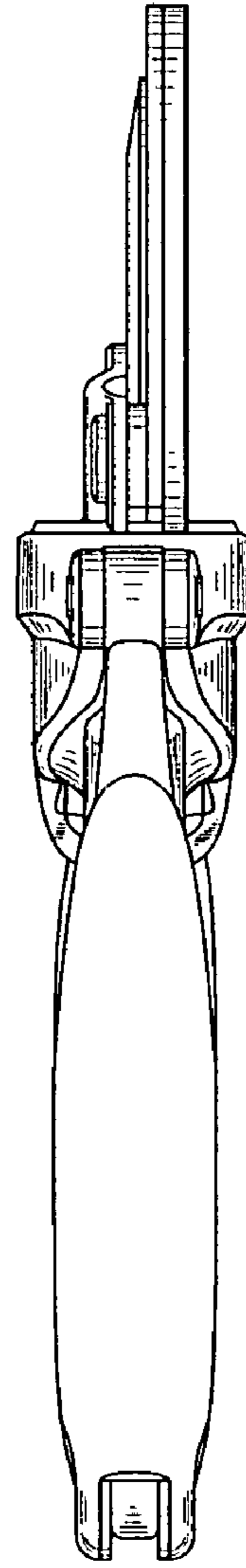

FIG. 5

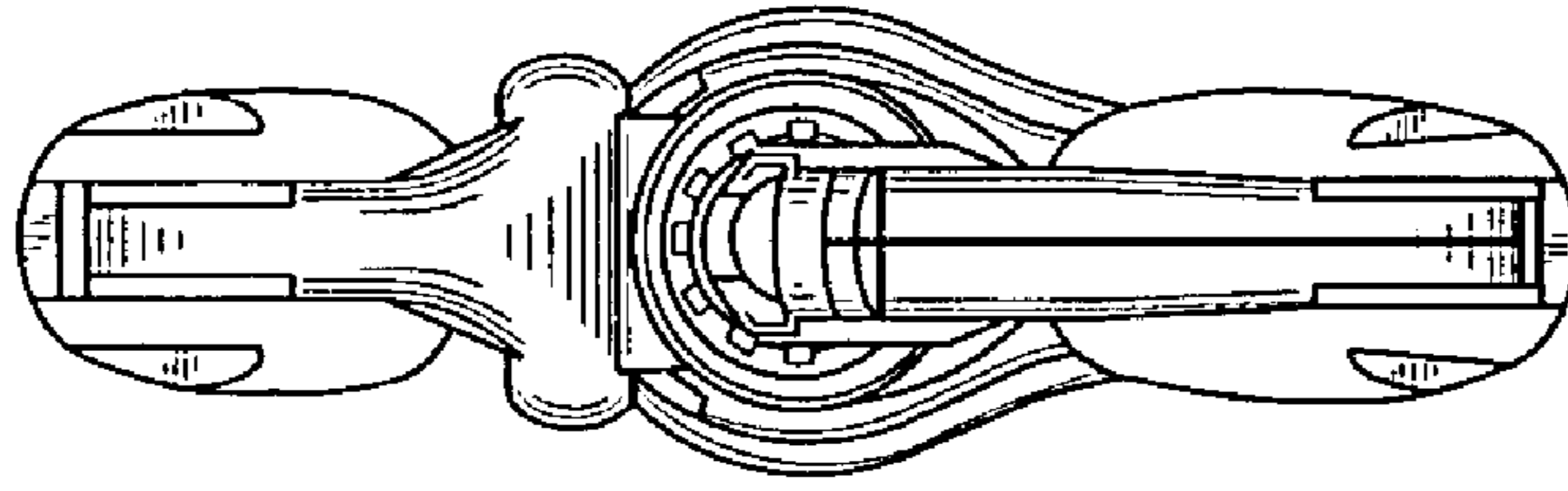

FIG. 6

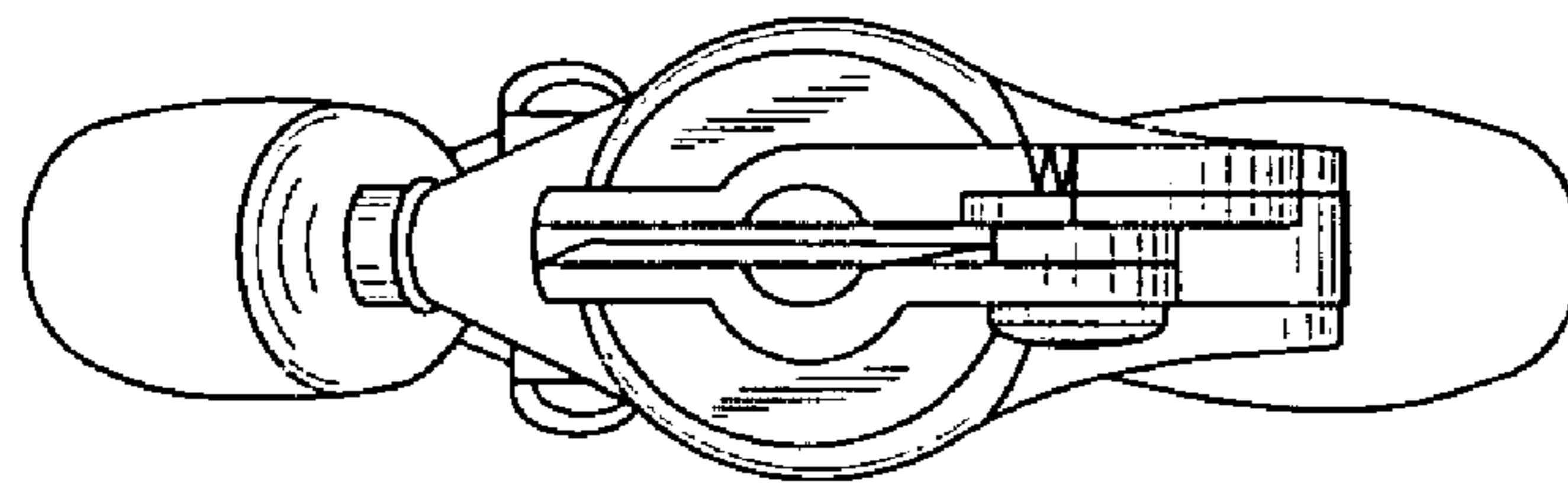

FIG. 7

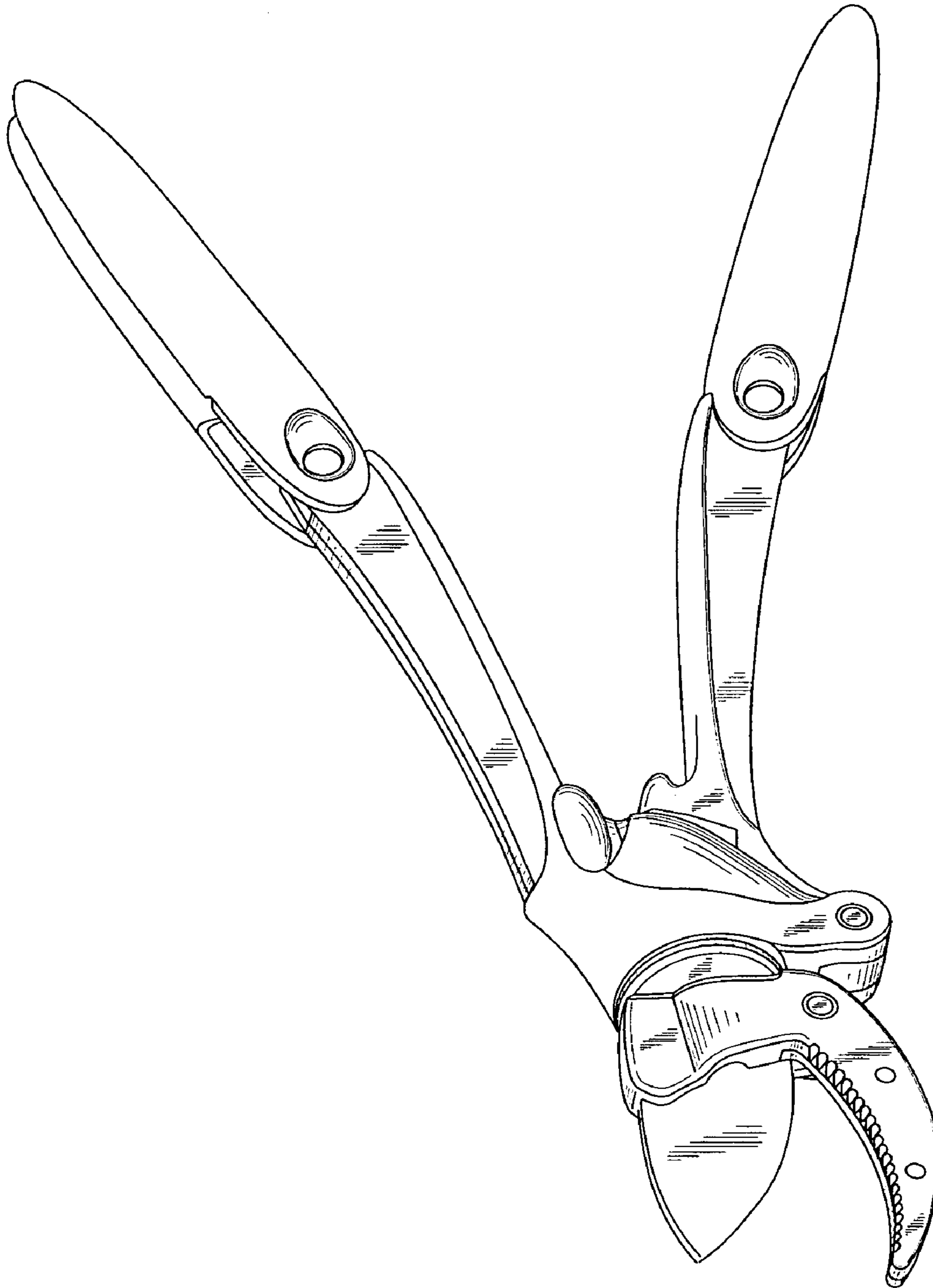

FIG. 8

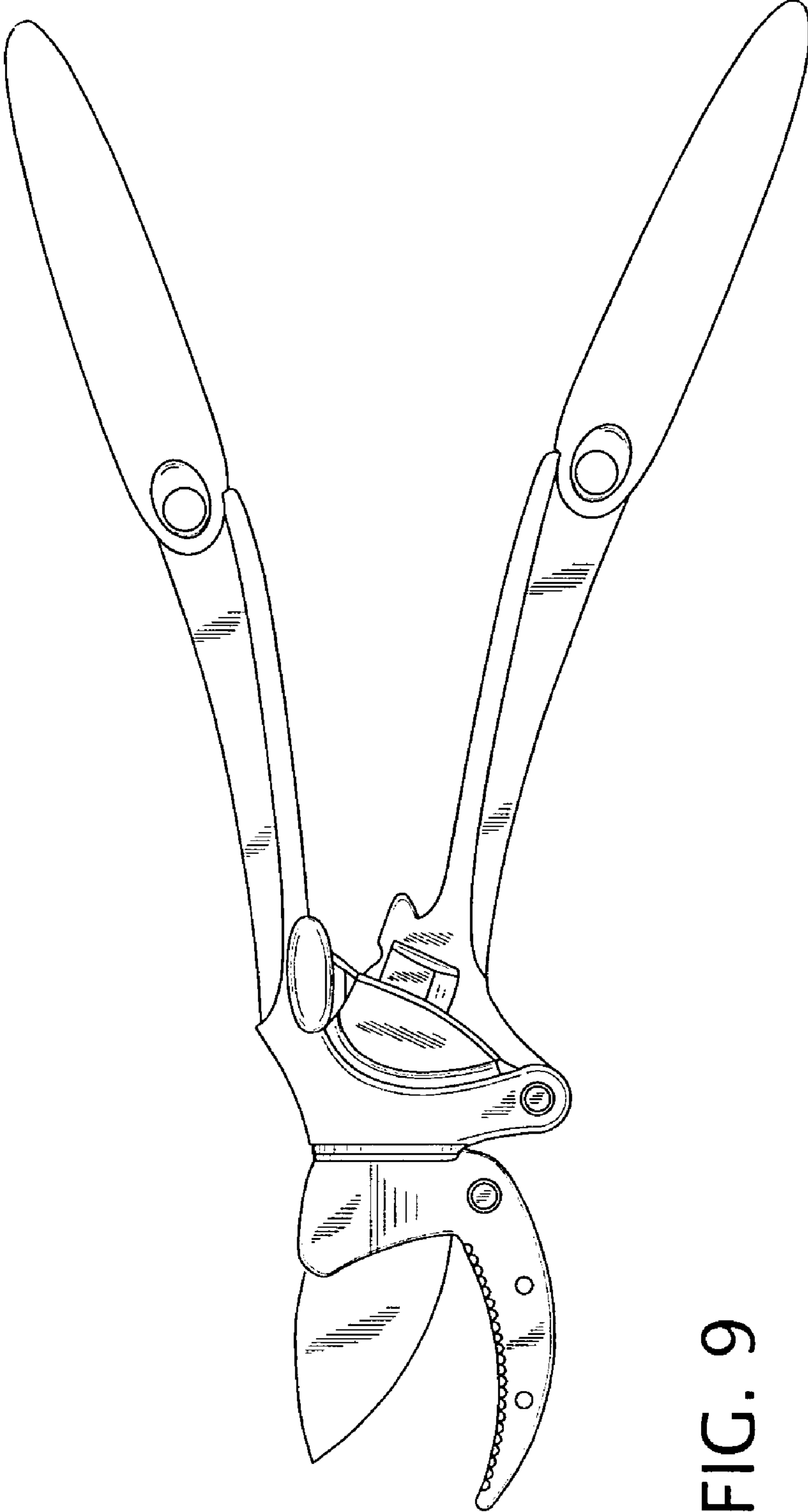

FIG. 9



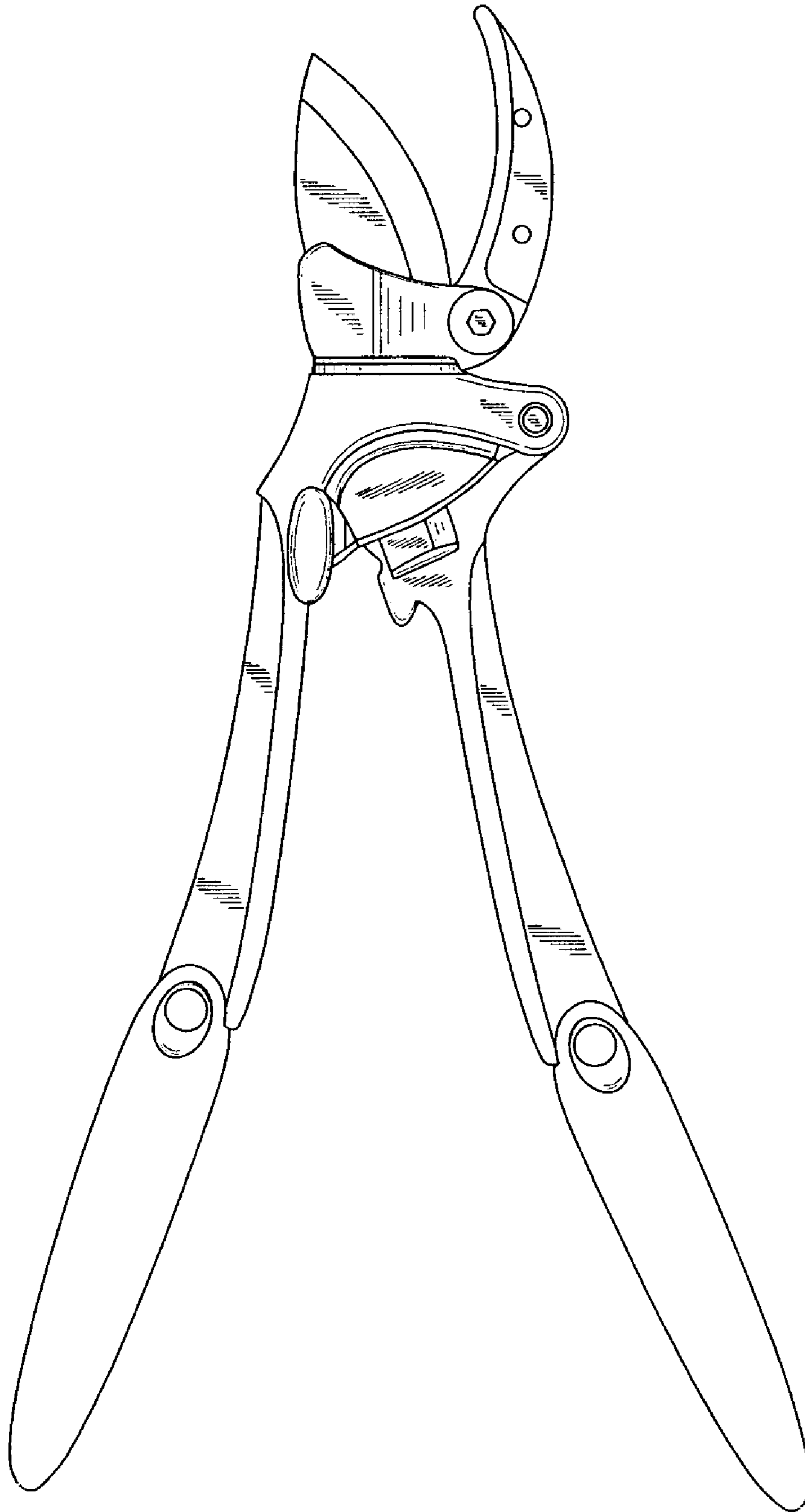

FIG. 10

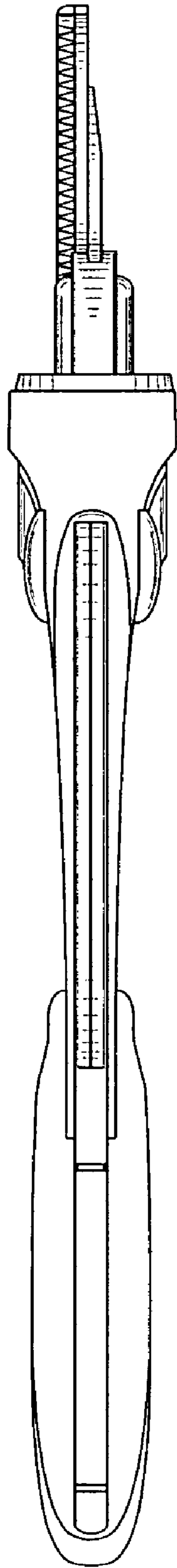

FIG. 11

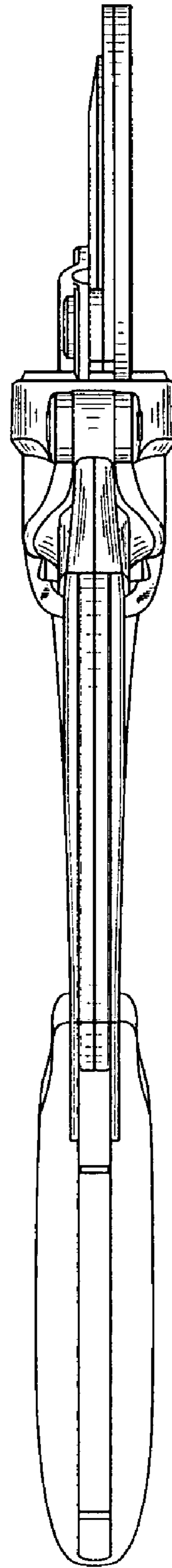

FIG. 12

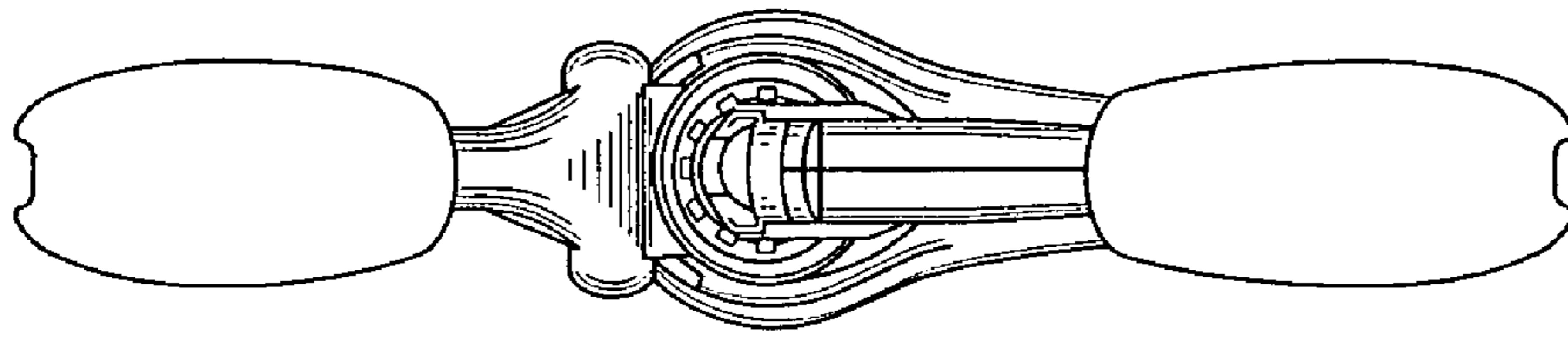

FIG. 14

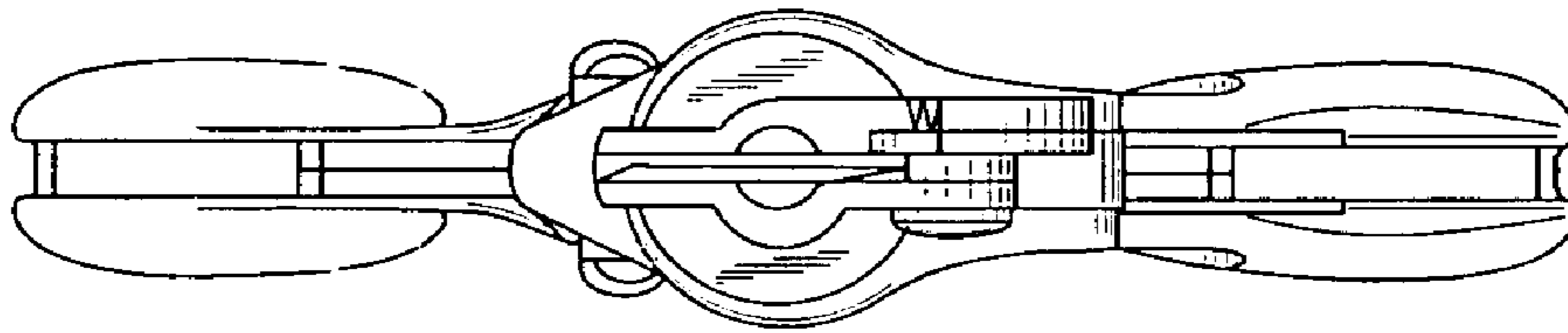

FIG. 13

UNITED STATES PATENT AND TRADEMARK OFFICE  
**CERTIFICATE OF CORRECTION**

PATENT NO. : Des. 548,027 S  
APPLICATION NO. : 29/235650  
DATED : August 7, 2007  
INVENTOR(S) : David Demar et al.

Page 1 of 1

It is certified that error appears in the above-identified patent and that said Letters Patent is hereby corrected as shown below:

In the first column of the cover page, below the listing of inventors' names and addresses, please add the following information:

Title Page, Item (73) Assignee: should read,

--(73) Assignee: Ames True Temper, Inc., Camp Hill, PA (US)--

Title Page, Item (74) should read,

--(74) Attorney, Agent, or Firm - David C. Jenkins, Eckert Seamans Cherin & Mellott, LLC.--

Signed and Sealed this

Twenty-first Day of April, 2009

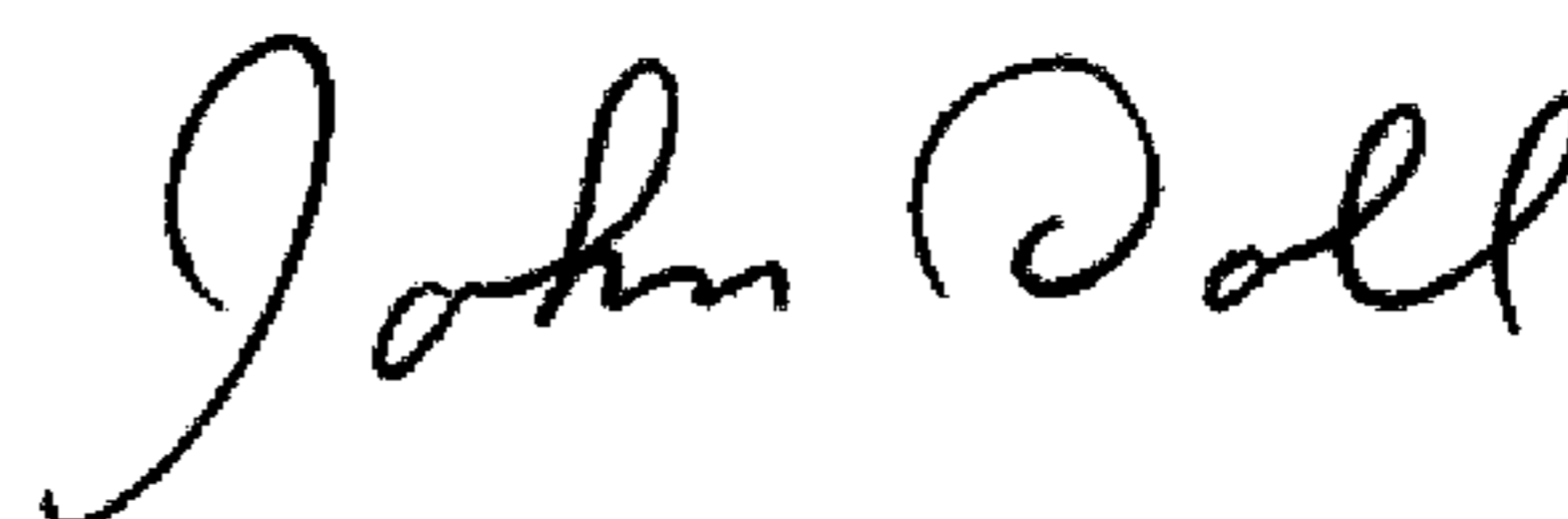

JOHN DOLL  
*Acting Director of the United States Patent and Trademark Office*