

US00D548003S

(12) **United States Design Patent** (10) **Patent No.:** **US D548,003 S**
Barth (45) **Date of Patent:** **** Aug. 7, 2007**

(54) **END FOR A COOKING ROD**

(75) Inventor: **Aaron Barth**, Carlisle, MA (US)

(73) Assignee: **Half-Time Ventures, Inc.**, Carlisle, MA (US)

(**) Term: **14 Years**

(21) Appl. No.: **29/264,789**

(22) Filed: **Aug. 17, 2006**

(51) **LOC (8) Cl.** **07-01**

(52) **U.S. Cl.** **D7/387**

(58) **Field of Classification Search** D7/532,
D7/540, 547, 560, 563-566, 578, 584, 500,
D7/506, 505, 510-511, 514, 515, 539, 538,
D7/558, 606, 613, 519, 559, 567, 342, 569,
D7/586, 602-603, 675, 676, 710, 619.2, 628,
D7/629, 637-639, 698, 642, 643, 323, 368,
D7/392.1, 395, 387-390, 699, 409, 345, 590,
D7/599, 623, 672; D9/310, 600, 601-603,
D9/644, 501; D11/48, 49, 58, 133, 134;
D21/414, 398, 415, 576, 609; 220/573.1;
206/320

See application file for complete search history.

(56) **References Cited**

U.S. PATENT DOCUMENTS

D35,771 S * 2/1902 Carlson D7/564

(Continued)

Primary Examiner—Philip S. Hyder

Assistant Examiner—Cynthia Underwood

(74) *Attorney, Agent, or Firm*—John C. Gorecki, Esq.

(57) **CLAIM**

The ornamental design for the end for a cooking rod, as shown and described.

DESCRIPTION

FIG. 1 is a front perspective view of an embodiment of an end for a cooking rod embodying my novel design;

FIG. 2 is a top plan view of the end for a cooking rod of FIG. 1;

FIG. 3 is a bottom plan view of the end for a cooking rod of FIG. 1;

FIG. 4 is a front elevational view of the end for a cooking rod of FIG. 1;

FIG. 5 is a back elevational view of the end for a cooking rod of FIG. 1;

FIG. 6 is a right side elevational view of the end for a cooking rod of FIG. 1;

FIG. 7 is a left side elevational view of the end for a cooking rod of FIG. 1;

FIG. 8 is a front perspective view of the end for a cooking rod of FIG. 1 shown connected to a spike component designed to pierce a piece of meat when in use;

FIG. 9 is a front perspective view of another embodiment of an end for a cooking rod embodying my novel design;

FIG. 10 is a top plan view of the end for a cooking rod of FIG. 9;

FIG. 11 is a bottom plan view of the end for a cooking rod of FIG. 9;

FIG. 12 is a front elevational view of the end for a cooking rod of FIG. 9;

FIG. 13 is a back elevational view of the end for a cooking rod of FIG. 9;

FIG. 14 is a right side elevational view of the end for a cooking rod of FIG. 9;

FIG. 15 is a left side elevational view of the end for a cooking rod of FIG. 9; and,

FIG. 16 is a front perspective view of the end for a cooking rod of FIG. 9 shown connected to a spike component designed to pierce a piece of meat when in use.

The broken lines shown in FIGS. 8 and 16 are for illustrative purposes only, to show one possible environment of the end for a cooking rod, and form no part of the claimed design.

1 Claim, 16 Drawing Sheets

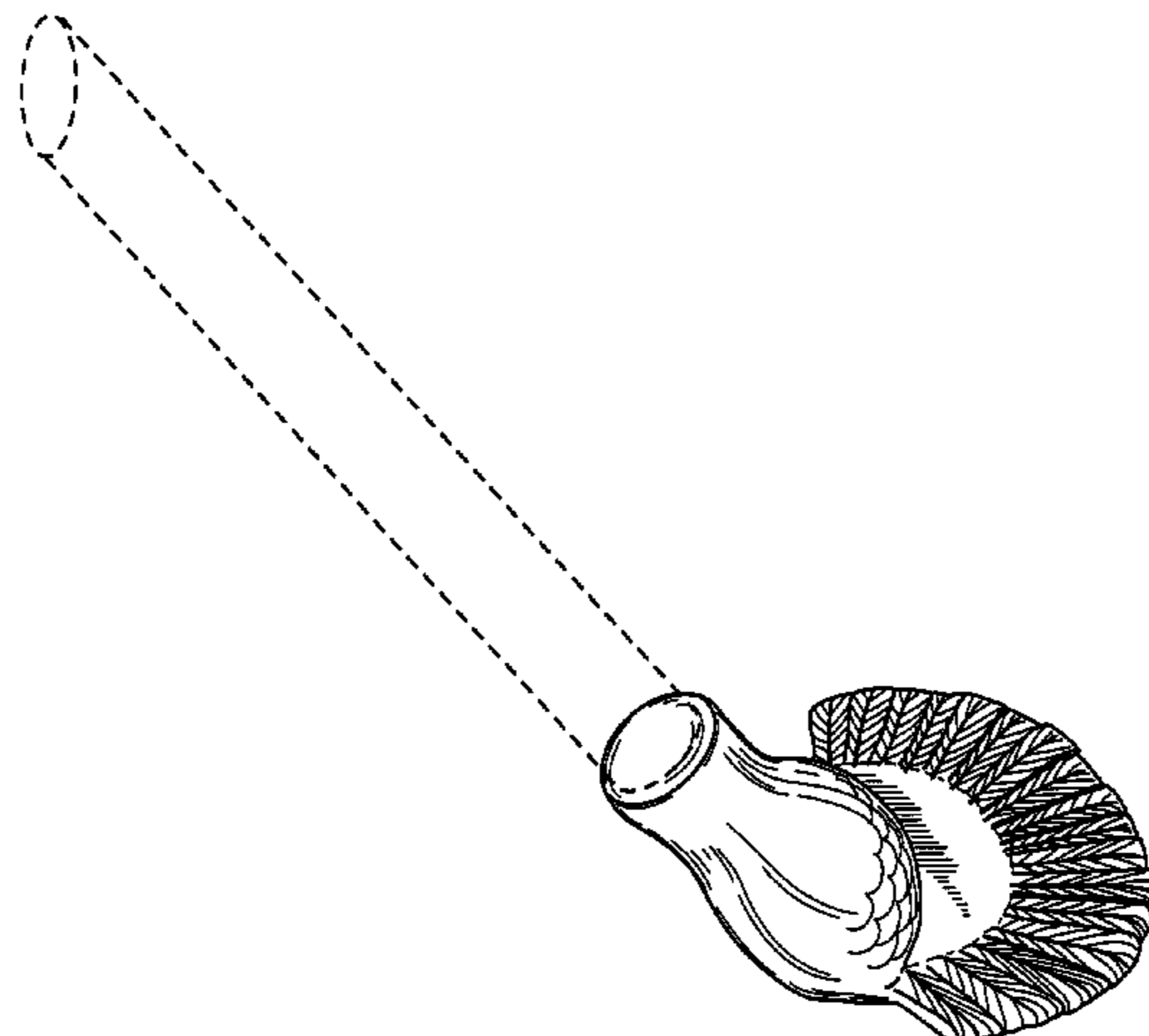

US D548,003 S

Page 2

U.S. PATENT DOCUMENTS

D69,106 S *	12/1925	Allebaugh	D11/162	D461,682 S *	8/2002	Fandrey	D7/409
1,678,226 A *	7/1928	Leigh	446/385	D509,546 S *	9/2005	DeLaney	D21/609
D92,475 S *	6/1934	Kissinger	D11/162	D510,499 S *	10/2005	Asimus	D7/387
4,127,060 A *	11/1978	Curtis	99/419	D525,471 S *	7/2006	Measom	D7/323
D411,463 S *	6/1999	Saputo	D1/107					

* cited by examiner

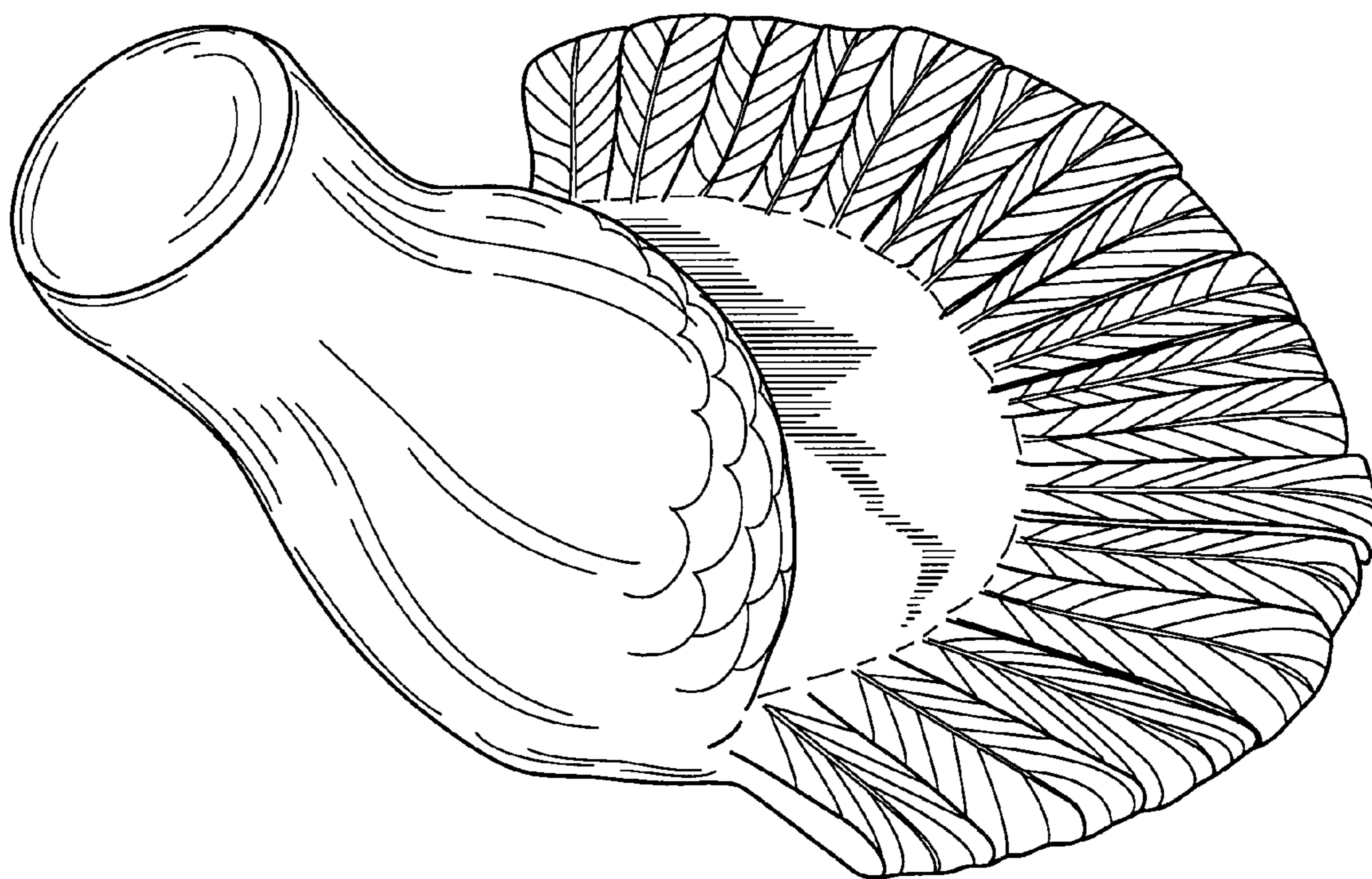

FIG. 1

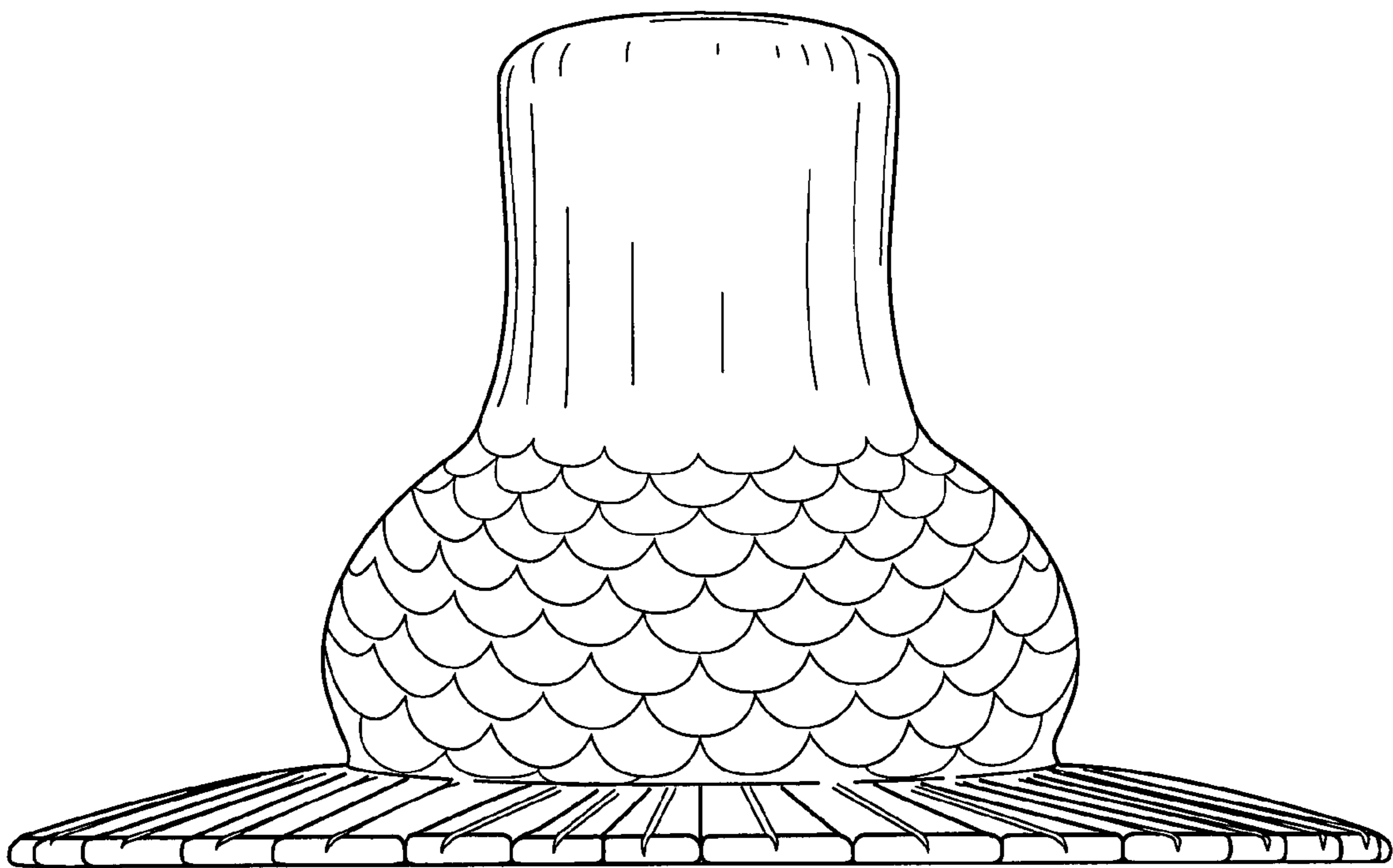

FIG. 2

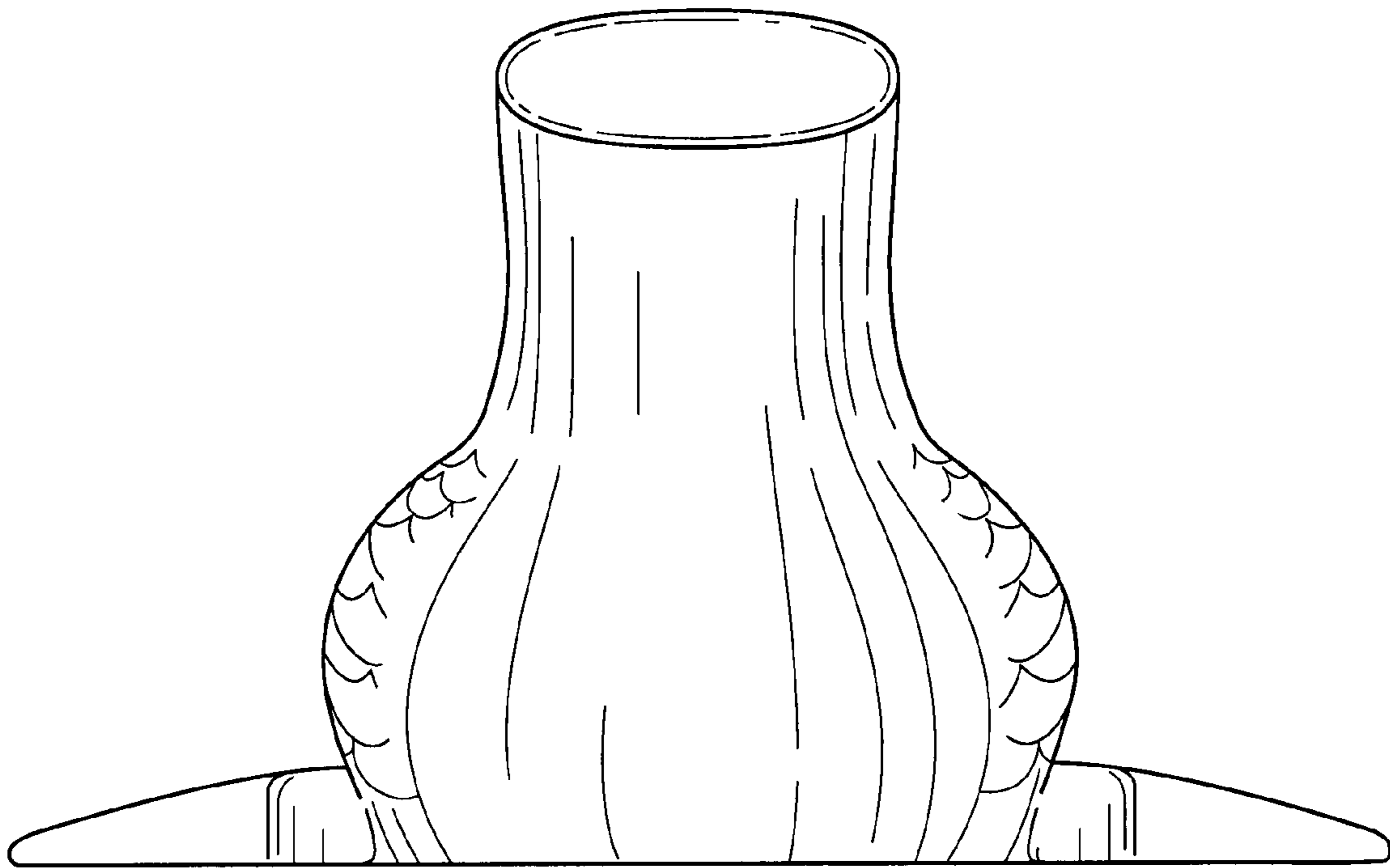

FIG. 3

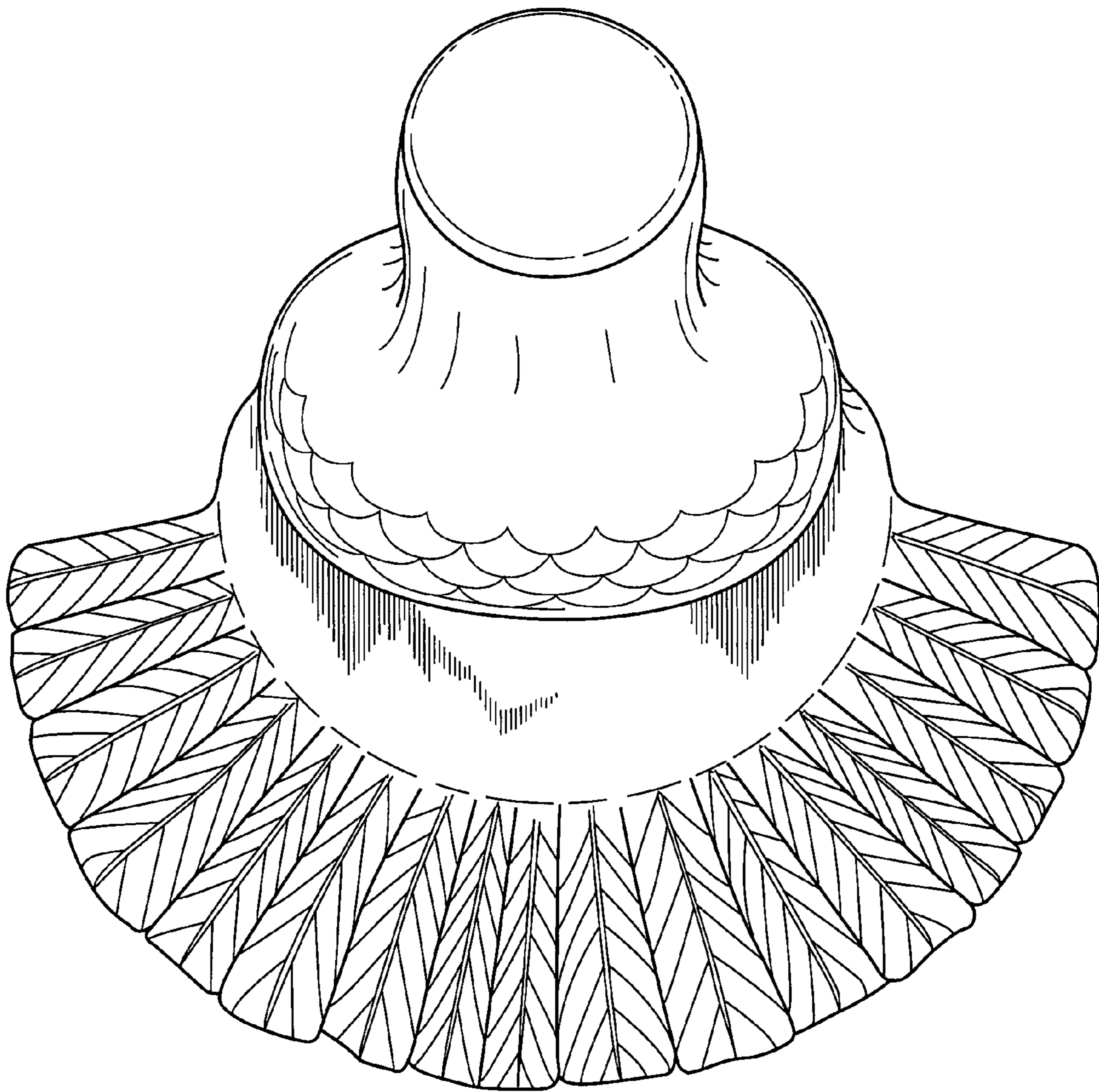

FIG. 4

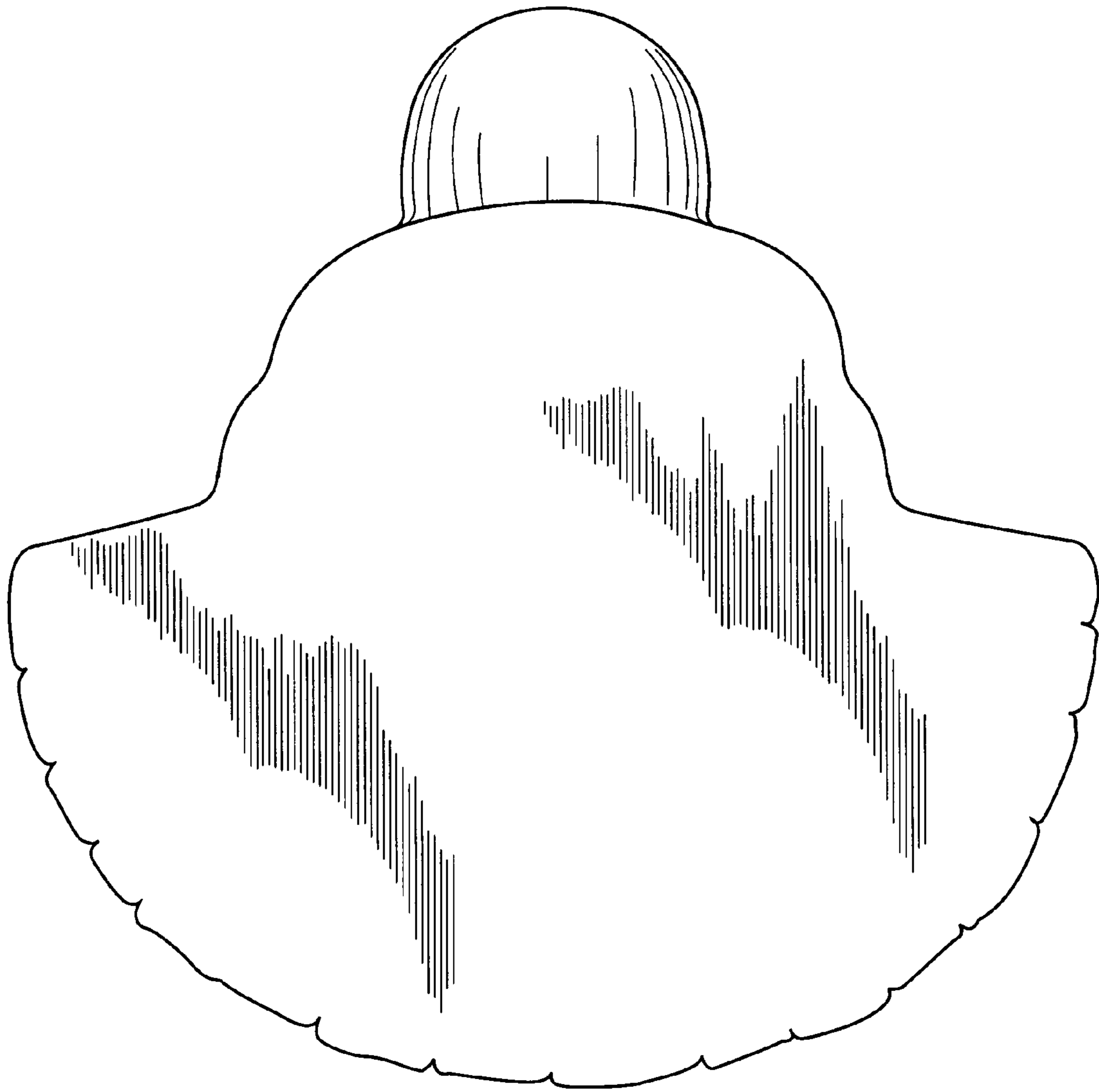

FIG. 5

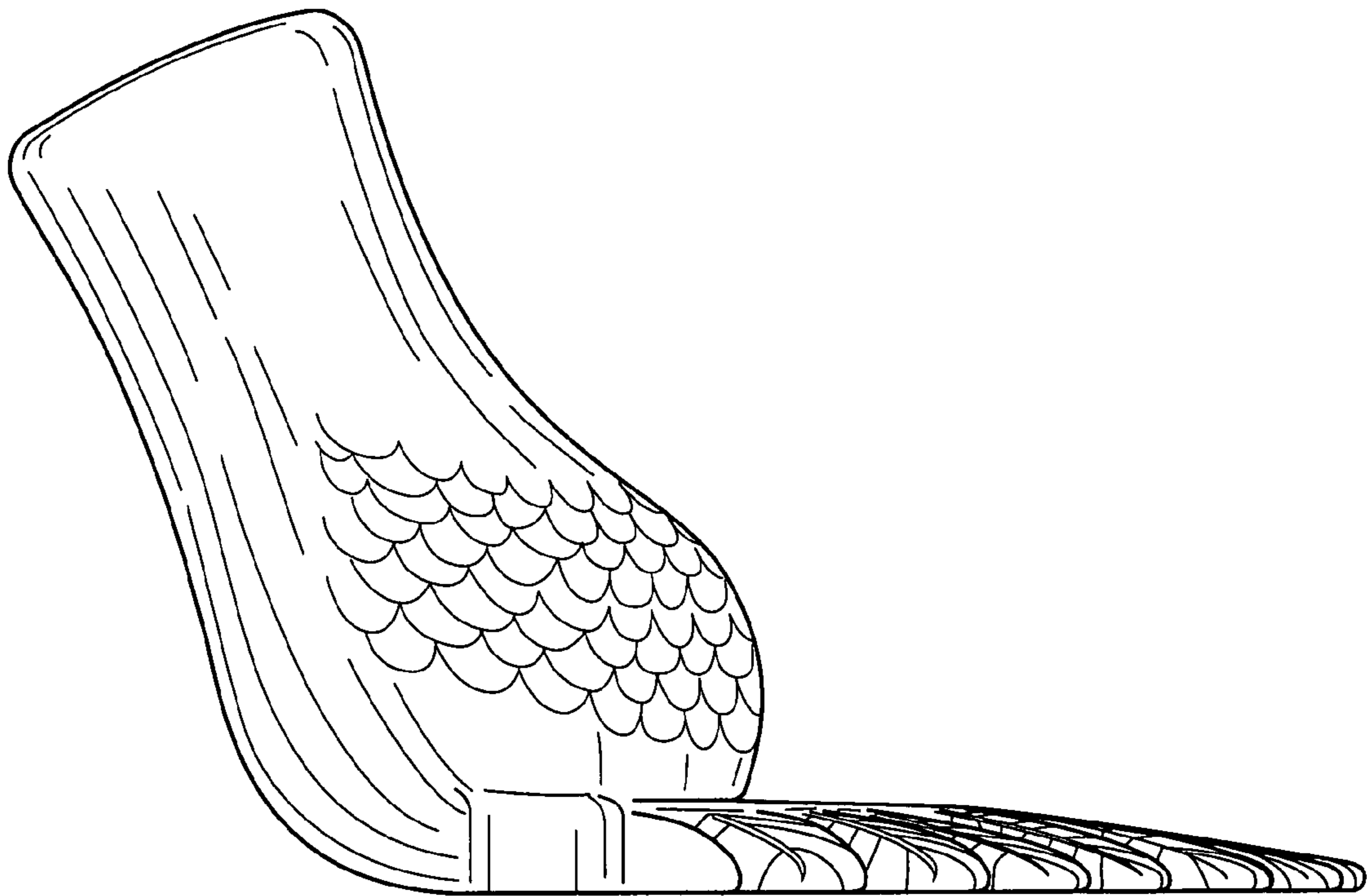

FIG. 6

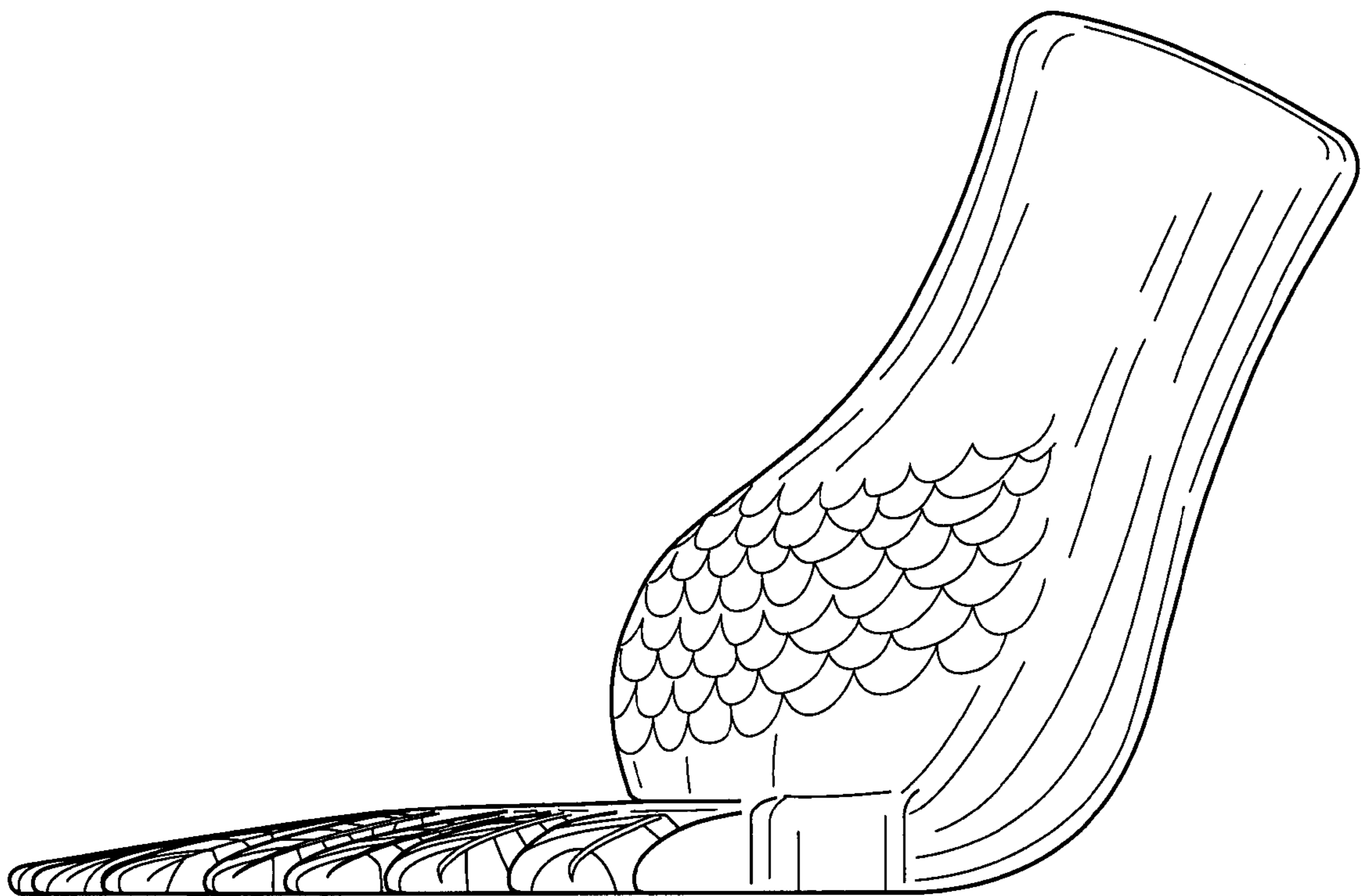

FIG. 7

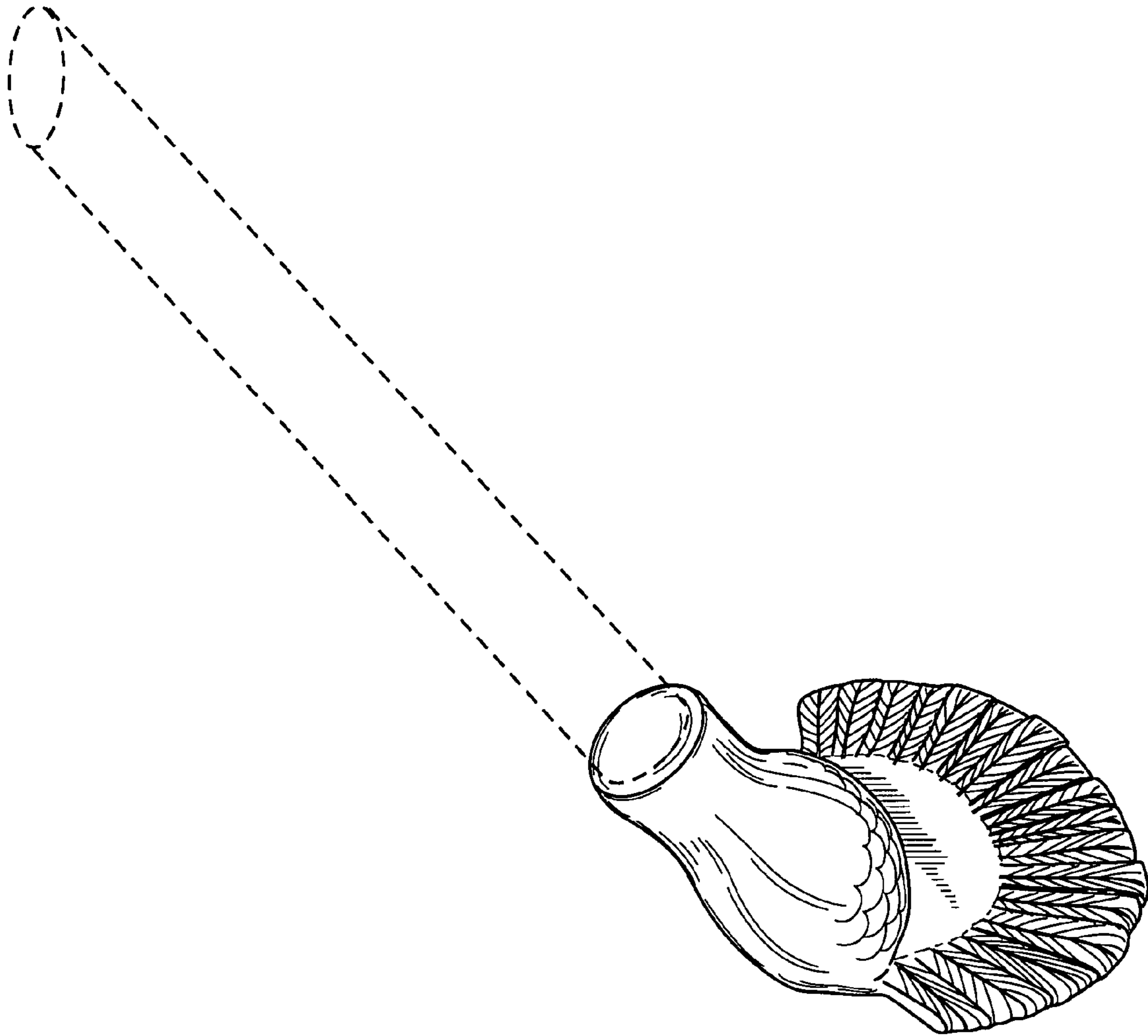

FIG. 8

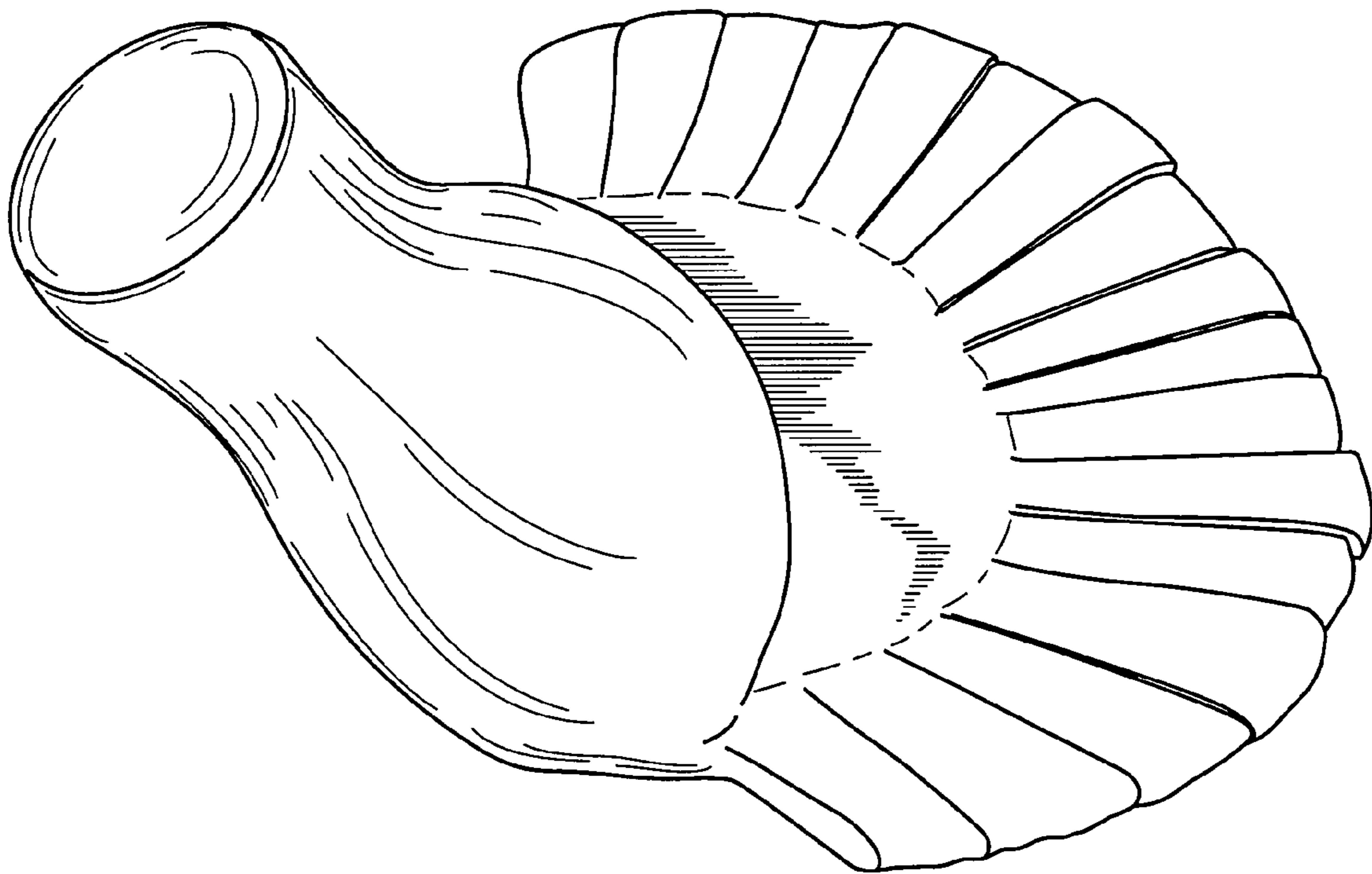

FIG. 9

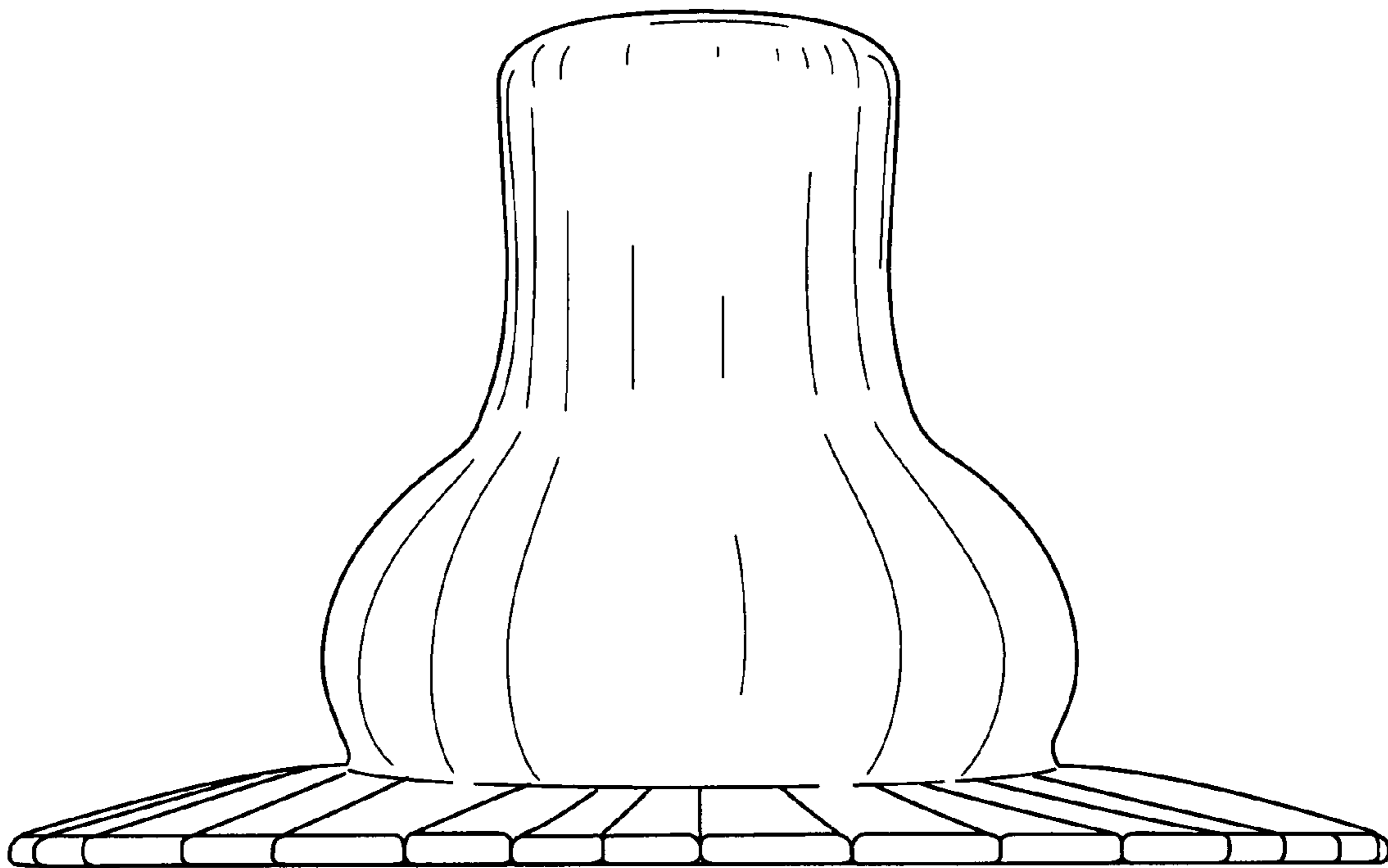

FIG. 10

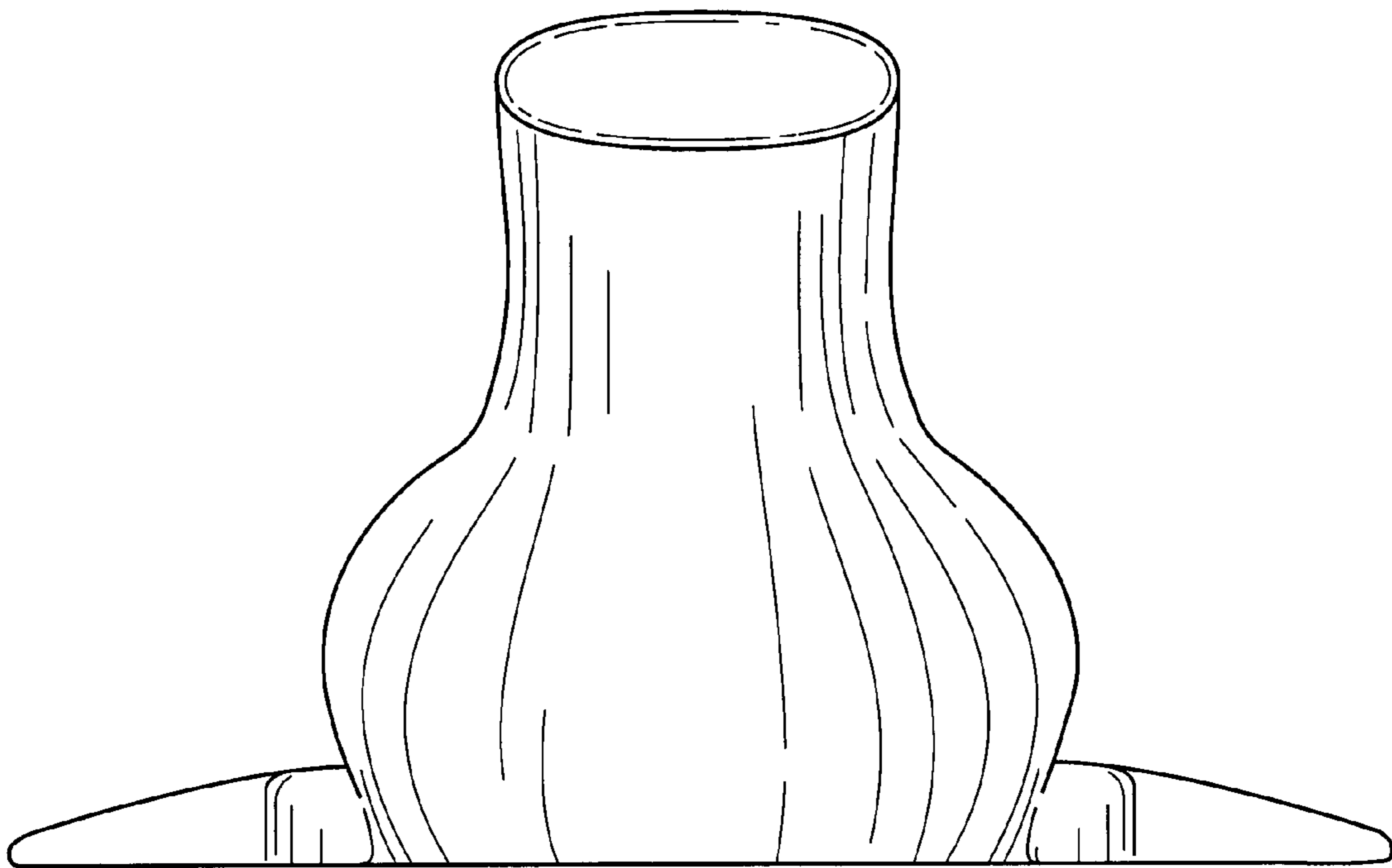

FIG. 11

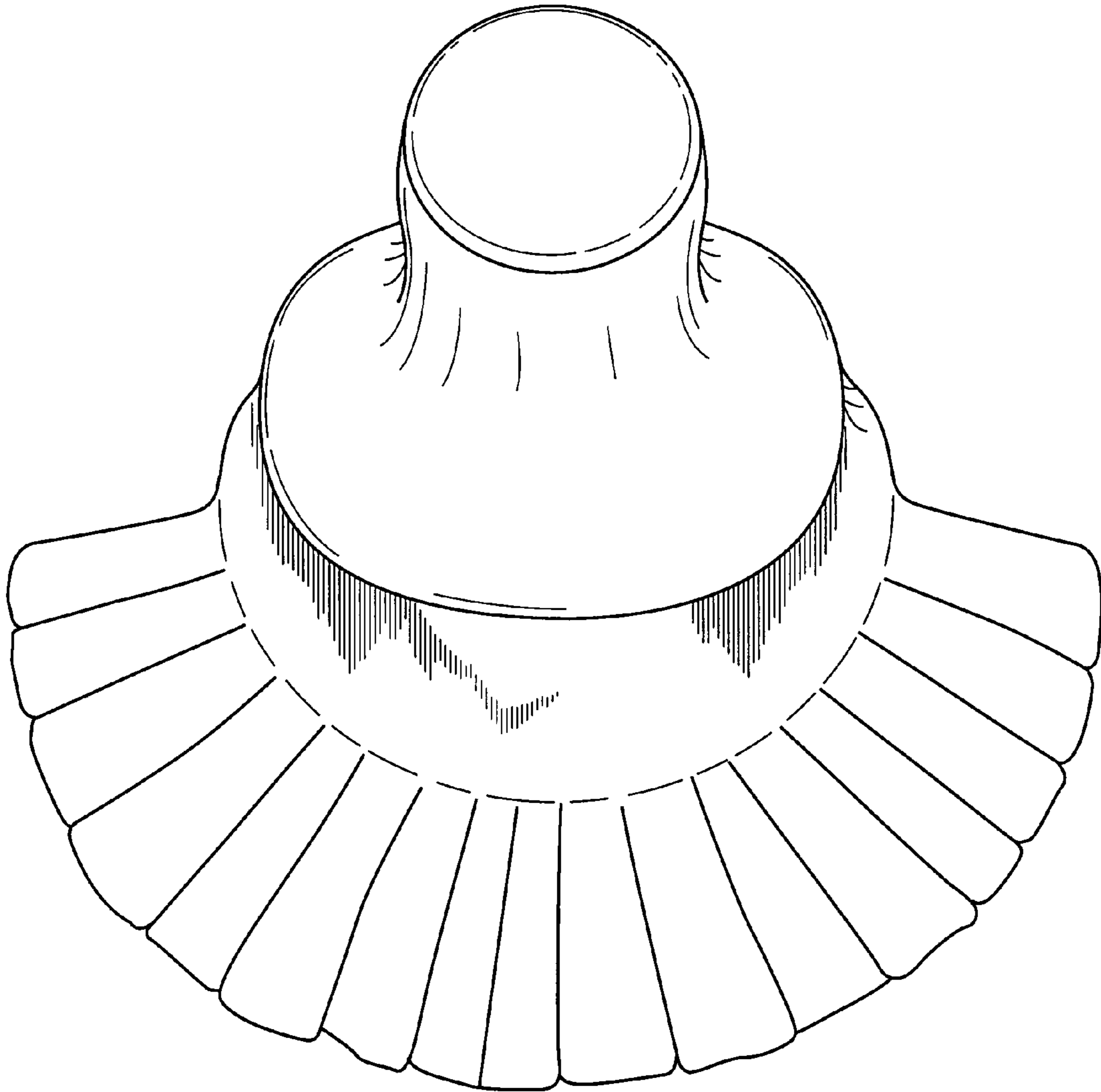

FIG. 12

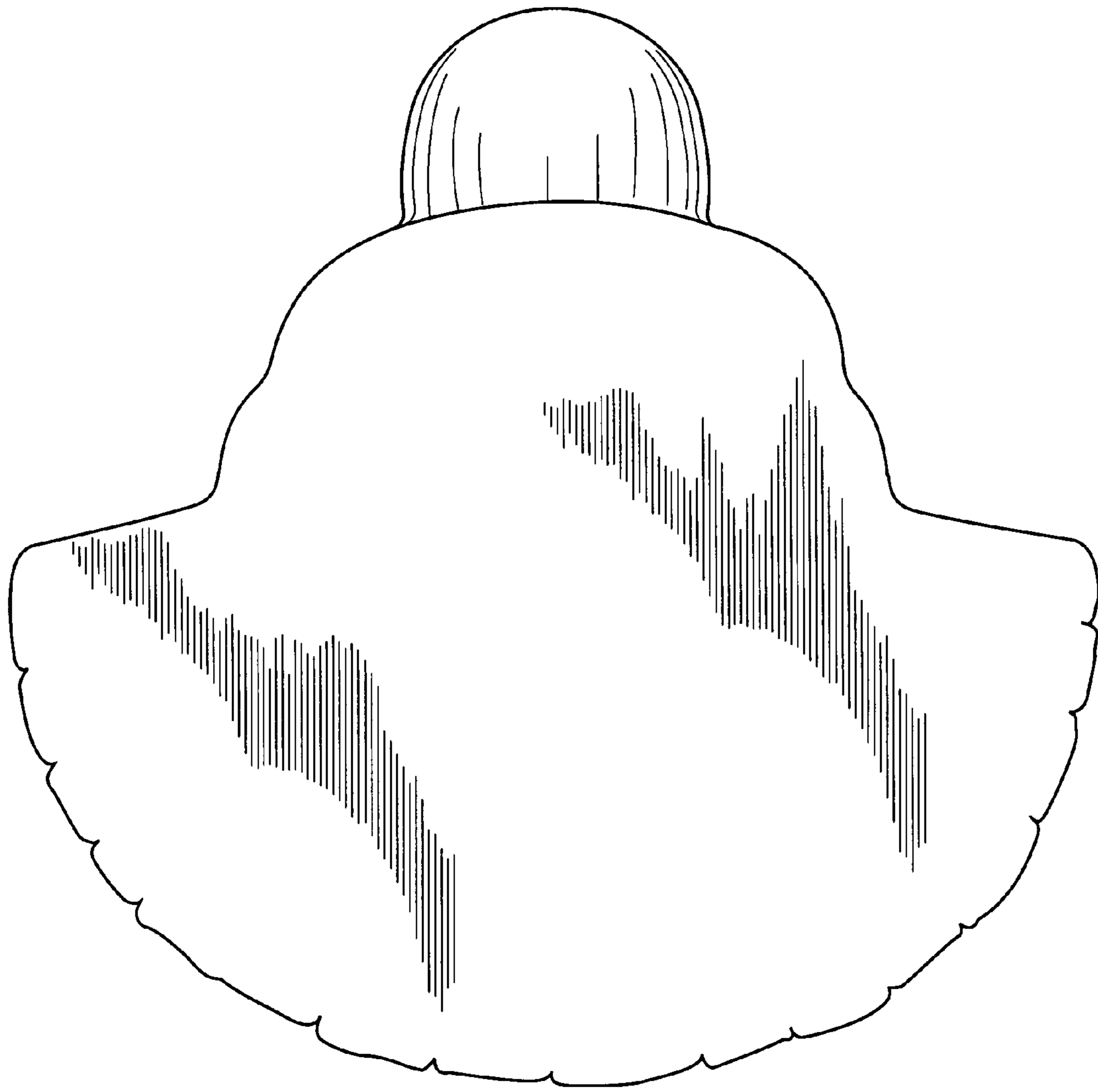

FIG. 13

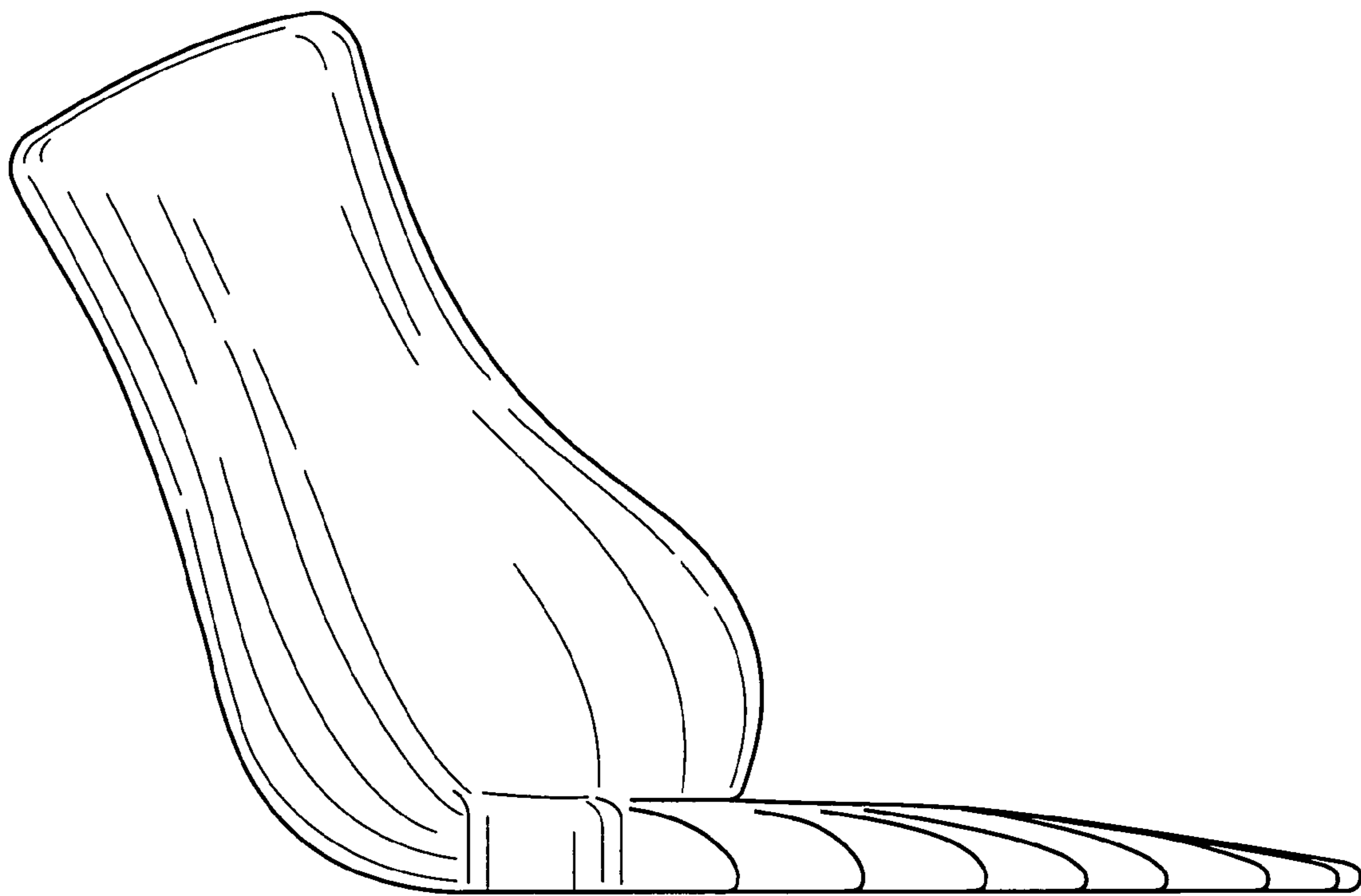

FIG. 14

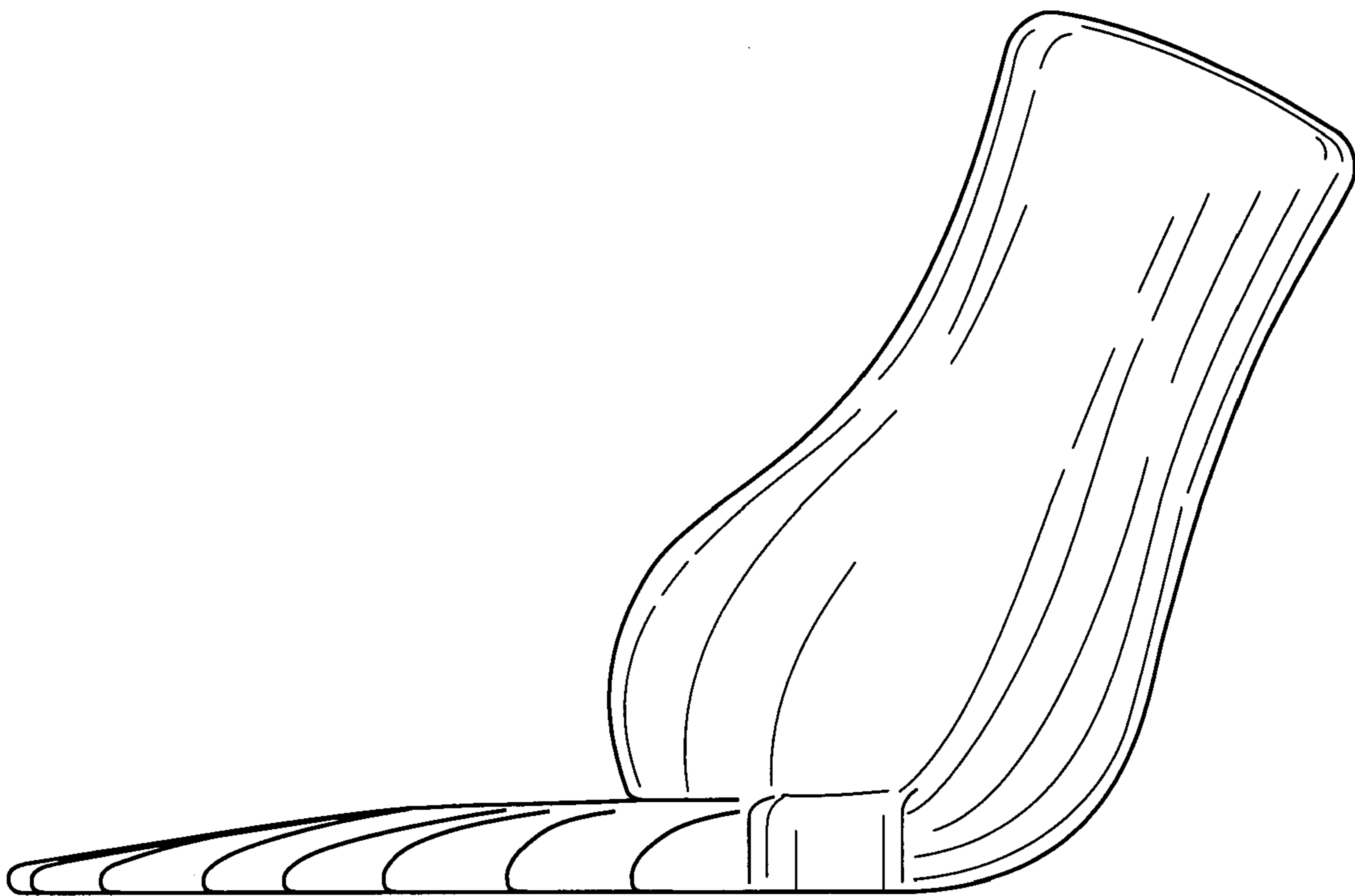

FIG. 15

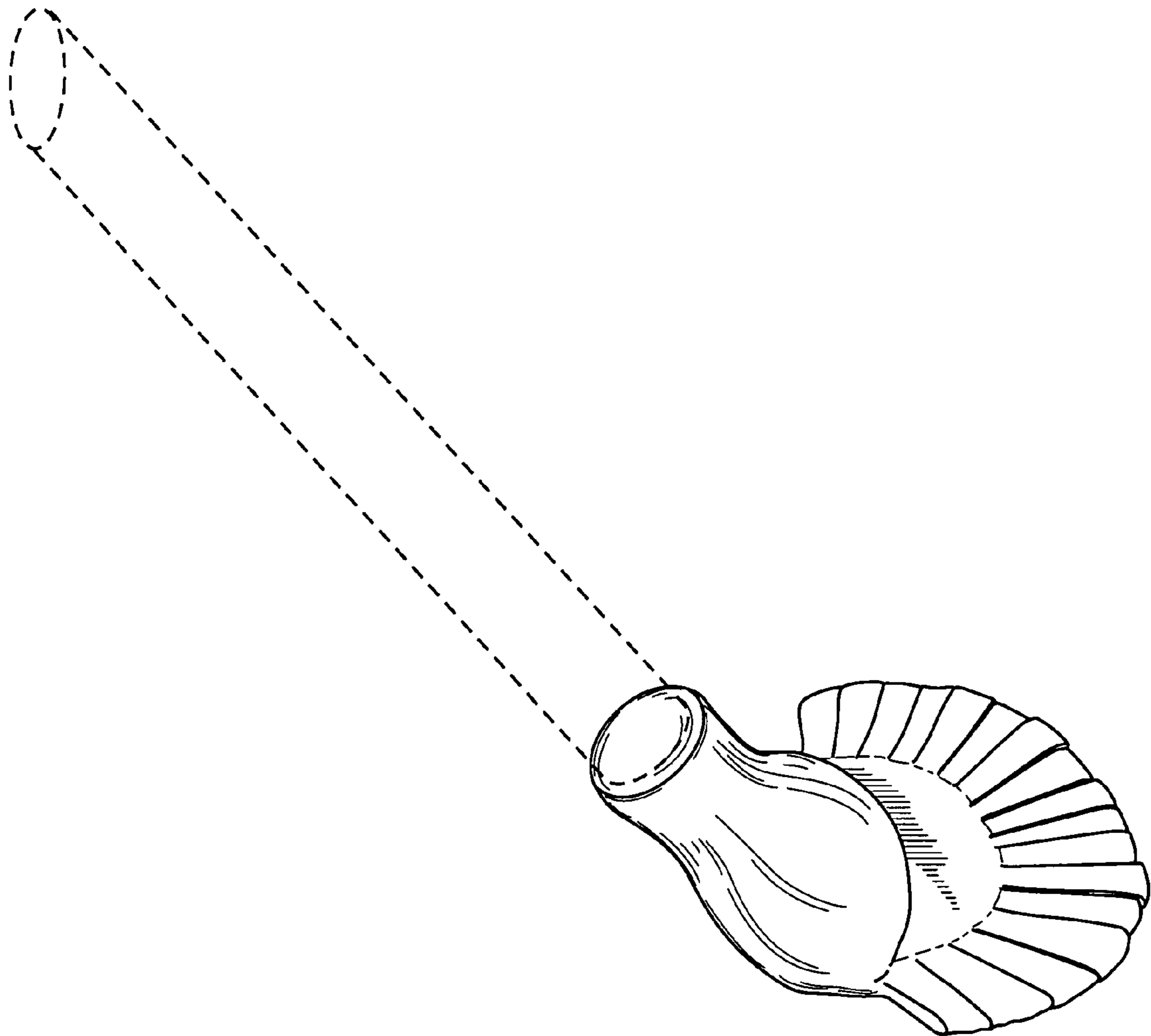

FIG. 16