

US00D547999S

(12) **United States Design Patent** (10) **Patent No.:** **US D547,999 S**
Katz (45) **Date of Patent:** **** Aug. 7, 2007**

(54) **POPCORN MAKING APPARATUS**

FOREIGN PATENT DOCUMENTS

(75) Inventor: **Mike Katz**, Woodland Hills, CA (US)

GB 2084078 * 12/1999

(73) Assignee: **Smart Innovations Inc.**, Canoga Park, CA (US)

* cited by examiner

(**) Term: **14 Years**

Primary Examiner—Cathron C. Brooks

Assistant Examiner—Ricky Pham

(21) Appl. No.: **29/248,417**

(74) *Attorney, Agent, or Firm*—L.A. Patents; David M. Kleiman

(22) Filed: **Aug. 15, 2006**

(57) **CLAIM**

(51) **LOC (8) Cl.** **31-00**

The ornamental design for the popcorn making apparatus, as shown and described.

(52) **U.S. Cl.** **D7/325**

DESCRIPTION

(58) **Field of Classification Search** D3/201, D3/212, 276, 315; D7/300, 305, 309–311, D7/323, 325, 354–361, 398, 500; D20/4; 99/275, 288, 289 P, 299, 323.3, 323.6–323.9, 99/442; 219/433, 441, 728–731, 735, 745, 219/762; 222/129.1, 130, 146.6; 426/106–107, 426/110, 234, 241, 243

FIG. 1 is a front perspective view of the design for a popcorn making apparatus.

FIG. 2 is a front elevational view of the popcorn making apparatus of FIG. 1.

FIG. 3 is a left side view of the popcorn making apparatus of FIG. 1.

FIG. 4 is a right side view of the popcorn making apparatus of FIG. 1.

FIG. 5 is a top plan view of the popcorn making apparatus of FIG. 1; and,

FIG. 6 is a bottom plan view of the popcorn making apparatus of FIG. 1.

The broken lines shown in the drawings are for illustrative purposes only and form no part of the claimed design.

See application file for complete search history.

(56) **References Cited**

U.S. PATENT DOCUMENTS

D334,950 S * 4/1993 Wyman et al. D20/4
D452,107 S * 12/2001 Cahen D7/309
D460,653 S * 7/2002 Cahen D7/309
D499,927 S * 12/2004 Lloyd D7/309
D513,572 S * 1/2006 Schaffeld et al. D7/309
D528,845 S * 9/2006 Zimmermann D7/309
D533,028 S * 12/2006 Cahen D7/398
D535,513 S * 1/2007 Zimmermann D7/309

1 Claim, 4 Drawing Sheets

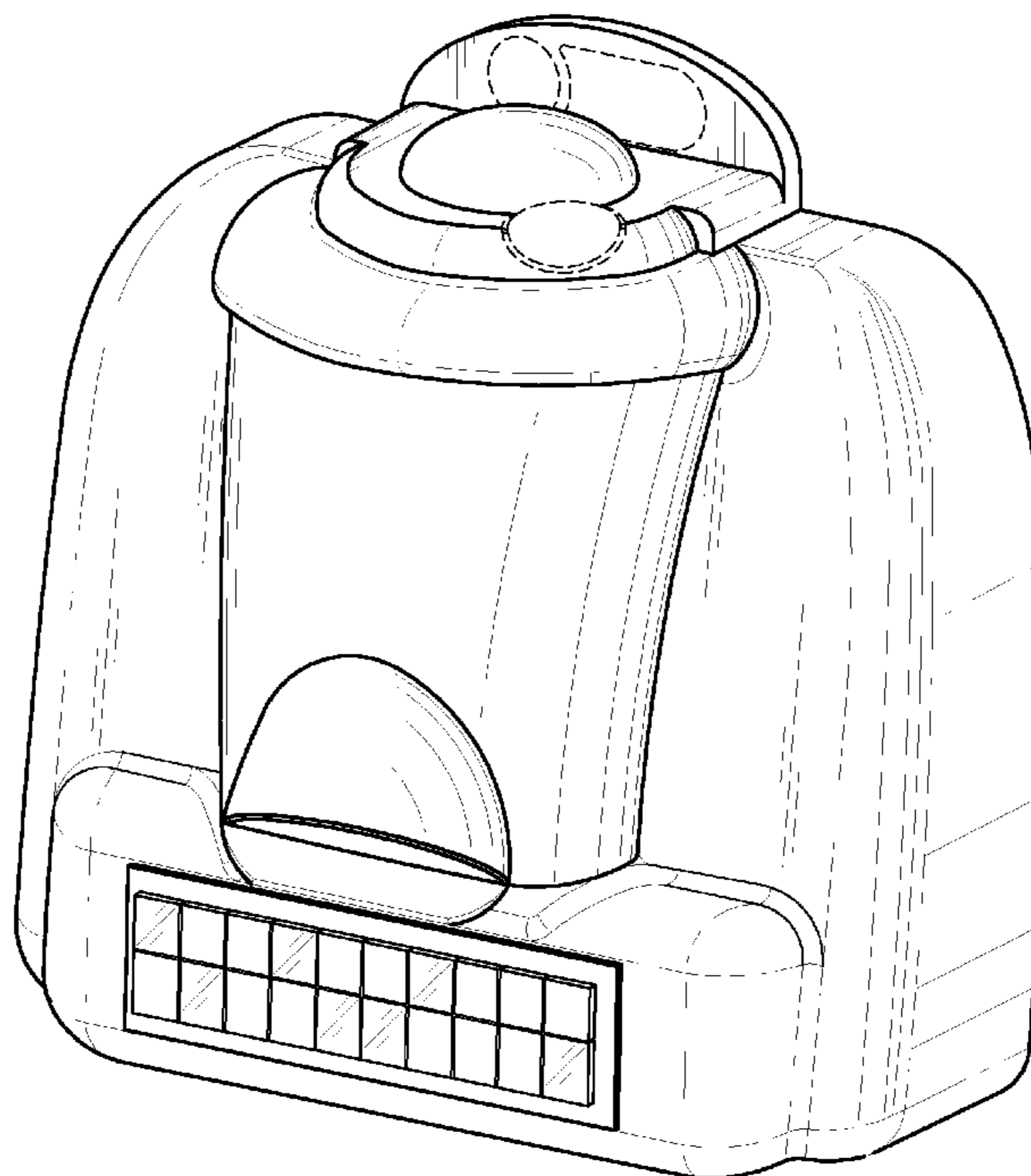

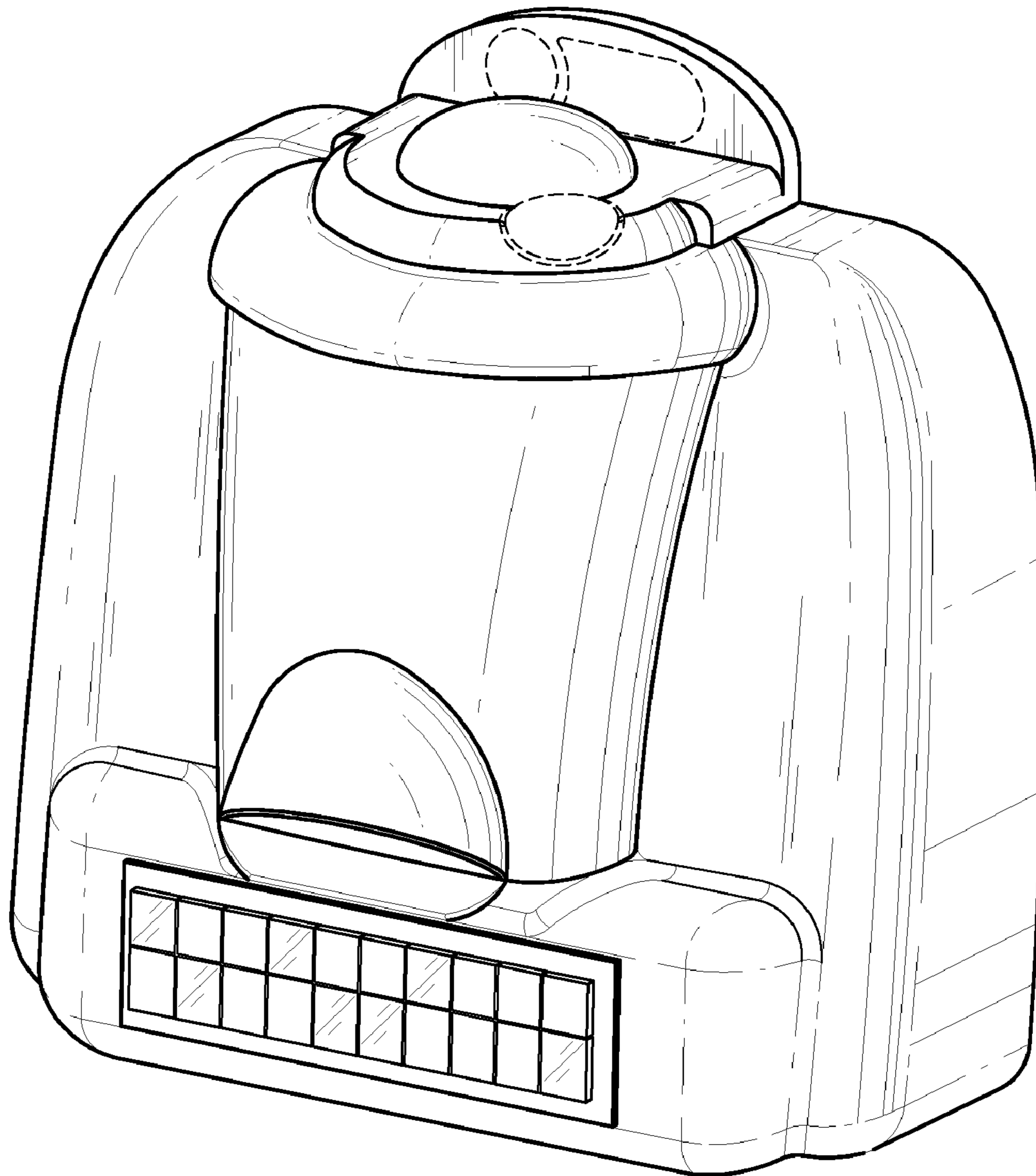

FIG. 1

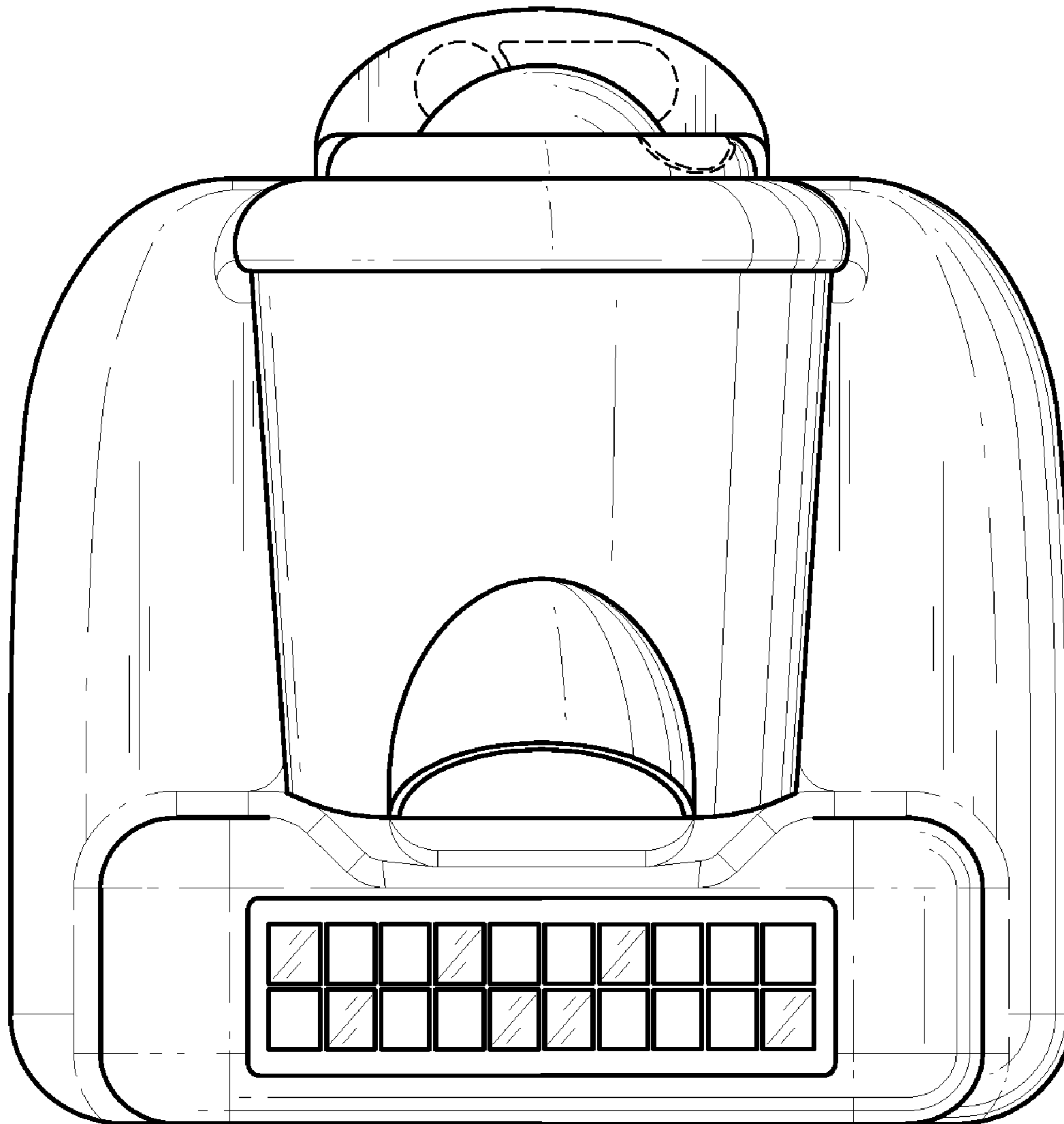

FIG. 2

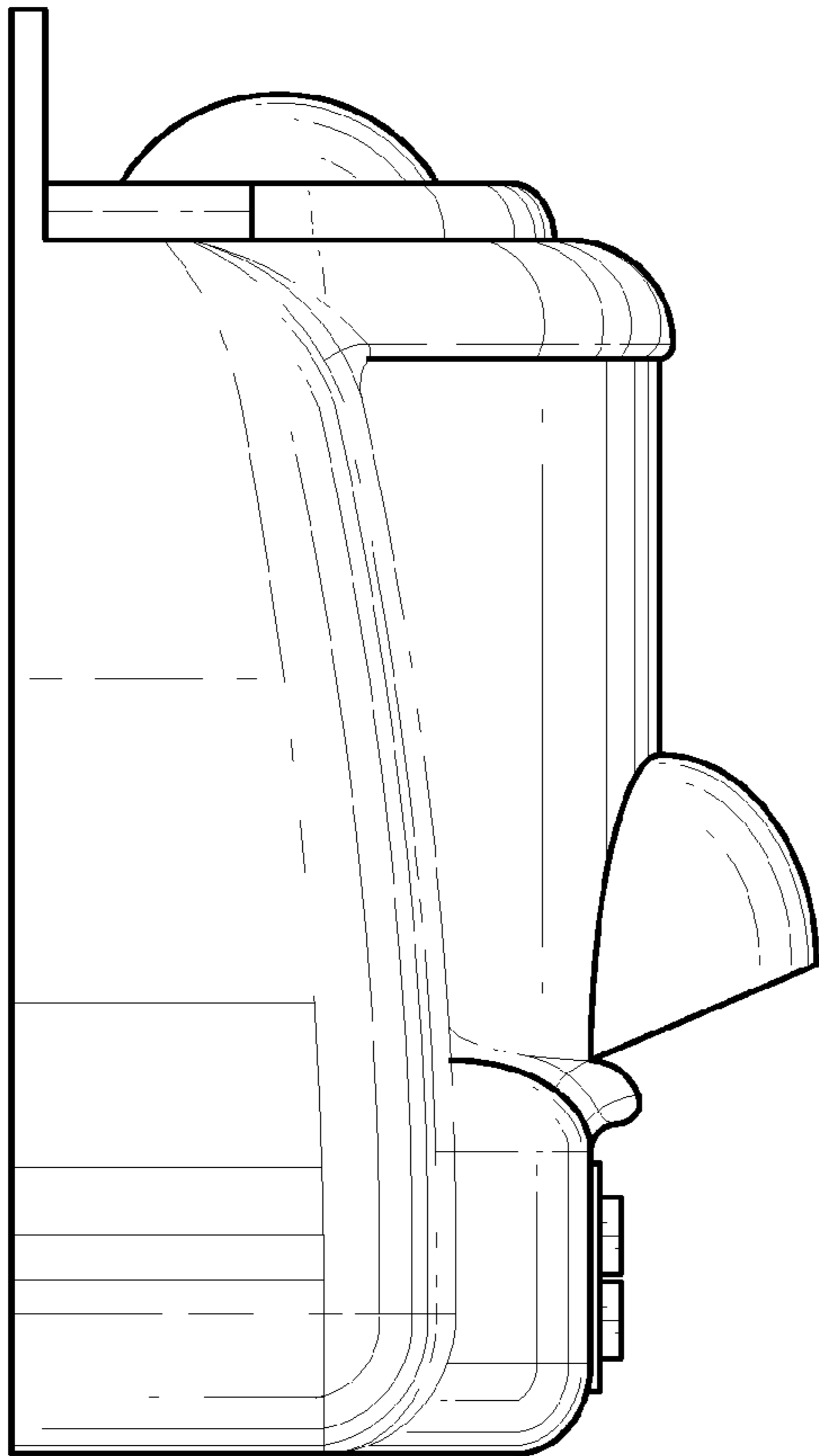

FIG. 3

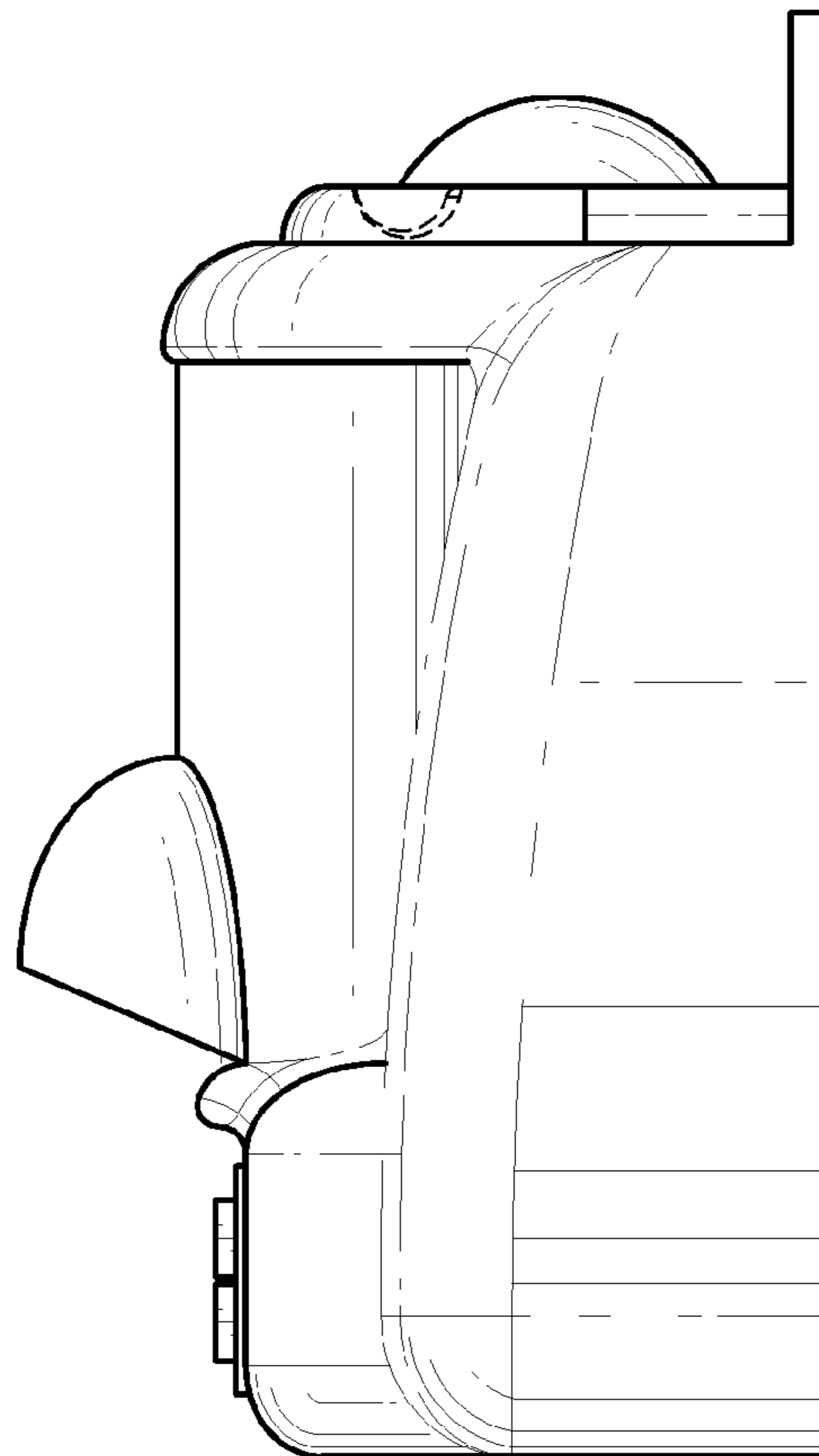

FIG. 4

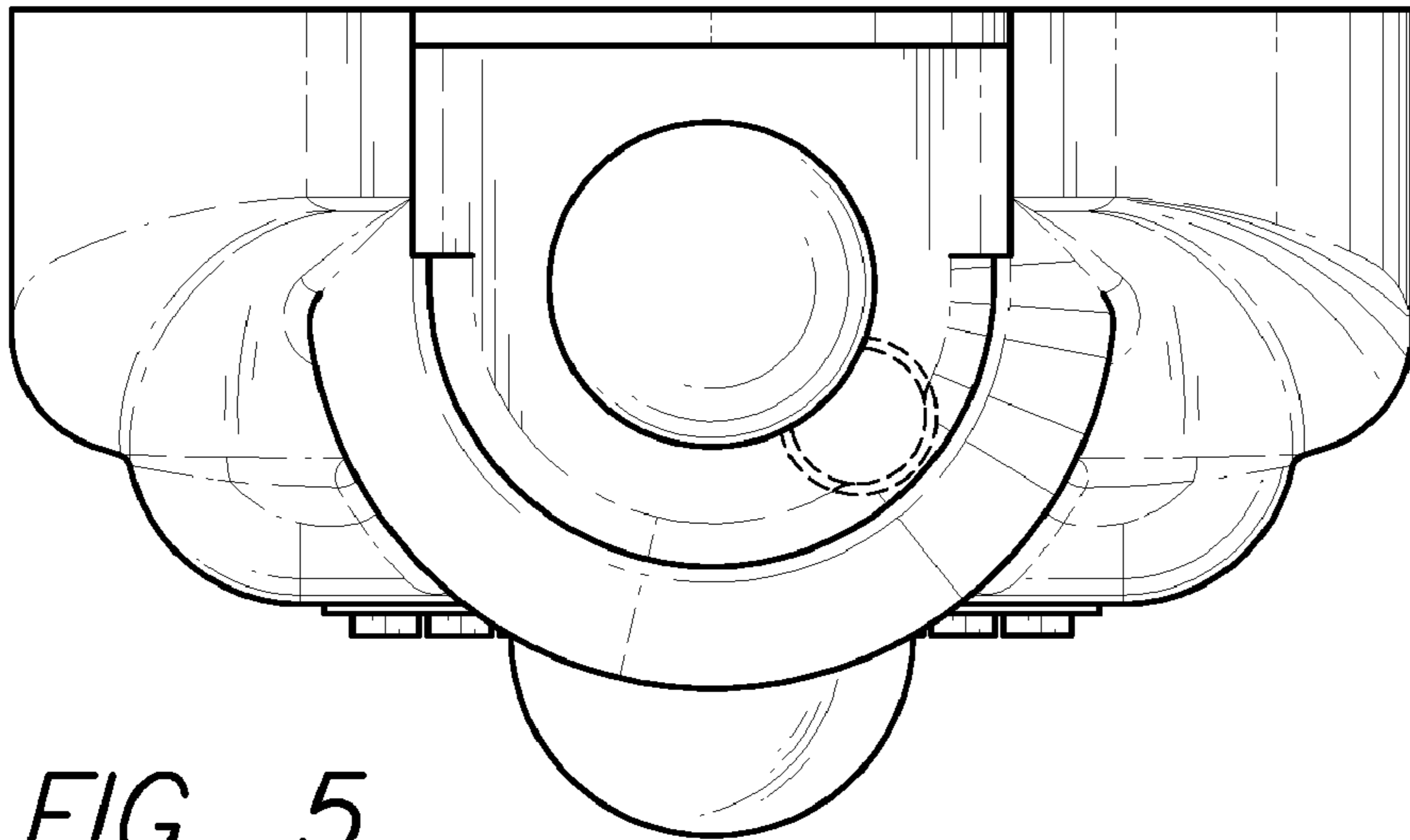

FIG. 5

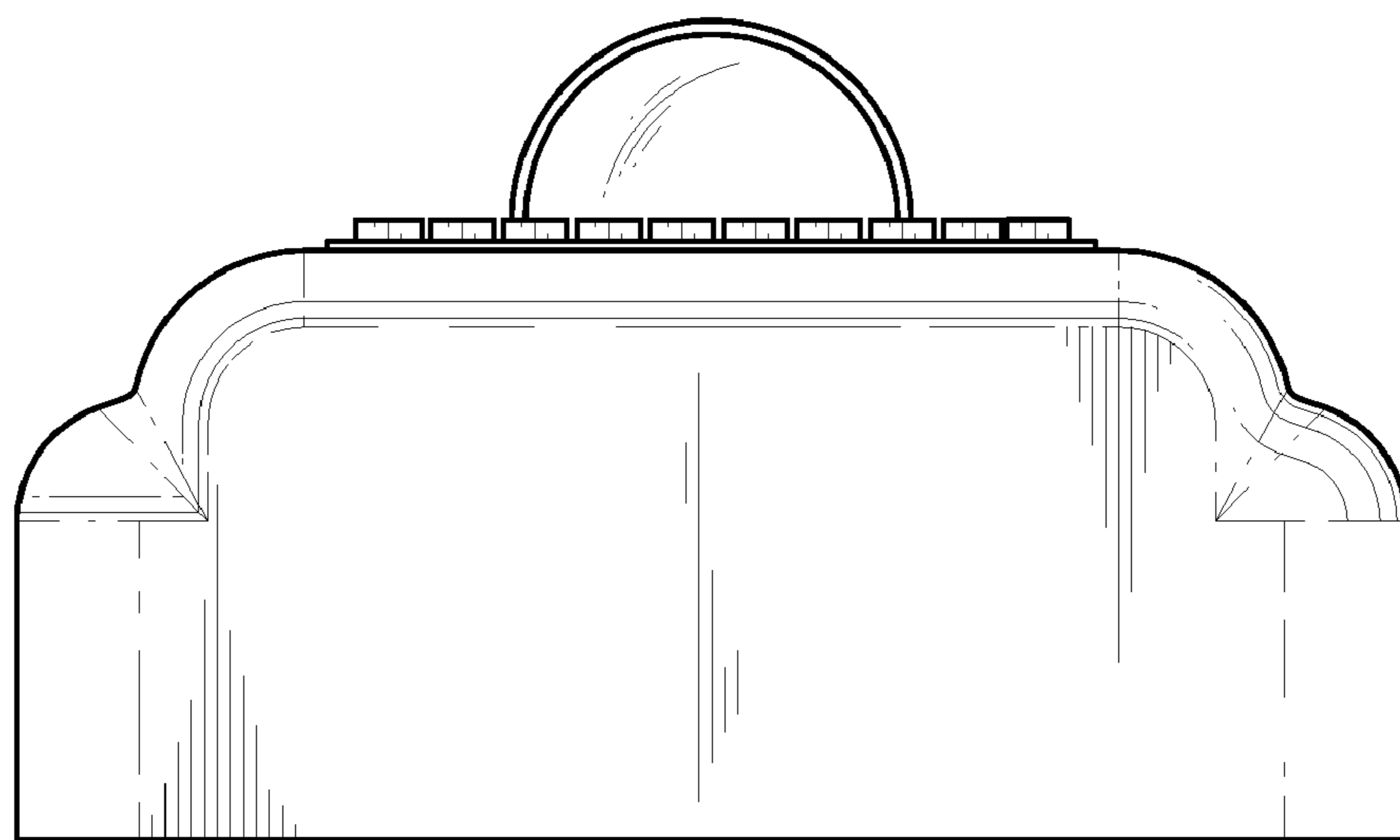

FIG. 6