

US00D547983S

(12) **United States Design Patent** (10) **Patent No.:** **US D547,983 S**
Jackson, III (45) **Date of Patent:** **** Aug. 7, 2007**

(54) **TOILET TISSUE HOLDER**

(76) Inventor: **Jewell Jackson, III**, 856 Tiger Dr., Columbus, OH (US) 43228

(**) Term: **14 Years**

(21) Appl. No.: **29/245,967**

(22) Filed: **Dec. 30, 2005**

(51) **LOC (8) Cl.** **20-02**

(52) **U.S. Cl.** **D6/520**

(58) **Field of Classification Search** D6/515-523;
D3/201; 206/389, 391, 407, 409; 312/34.1,
312/34.8; 211/16, 85.5, 59.2; 221/92, 97,
221/185, 282-284; 242/159, 160.2, 550,
242/560, 590, 595, 588, 598

See application file for complete search history.

(56) **References Cited**

U.S. PATENT DOCUMENTS

D421,690 S *	3/2000	Sutherland	D6/520
D508,354 S *	8/2005	D'Agostino	D6/520
D511,429 S *	11/2005	Lor	D6/520
D529,320 S *	10/2006	Corral	D6/518

* cited by examiner

Primary Examiner—Brian N Vinson
(74) *Attorney, Agent, or Firm*—Porter, Wright, Morris & Arthur, LLP

(57) **CLAIM**

The ornamental design for a toilet tissue holder, as shown and described.

DESCRIPTION

FIG. 1 is a perspective view of a toilet tissue holder showing my new design;

FIG. 2 is a left side elevational view of the toilet tissue holder of FIG. 1, the right side elevational view being a mirror image thereof;

FIG. 3 is a front side elevational view of the toilet tissue holder of FIGS. 1 and 2;

FIG. 4 is a rear side elevational view of the toilet tissue holder of FIGS. 1 to 3;

FIG. 5 is top planar view of the toilet tissue holder of FIGS. 1 to 4; and,

FIG. 6 is a bottom planar view of the toilet tissue holder of FIGS. 1 to 5.

The broken-line disclosure of a tissue roll in the views is for illustrative purposes only and forms no part of the claimed design.

1 Claim, 5 Drawing Sheets

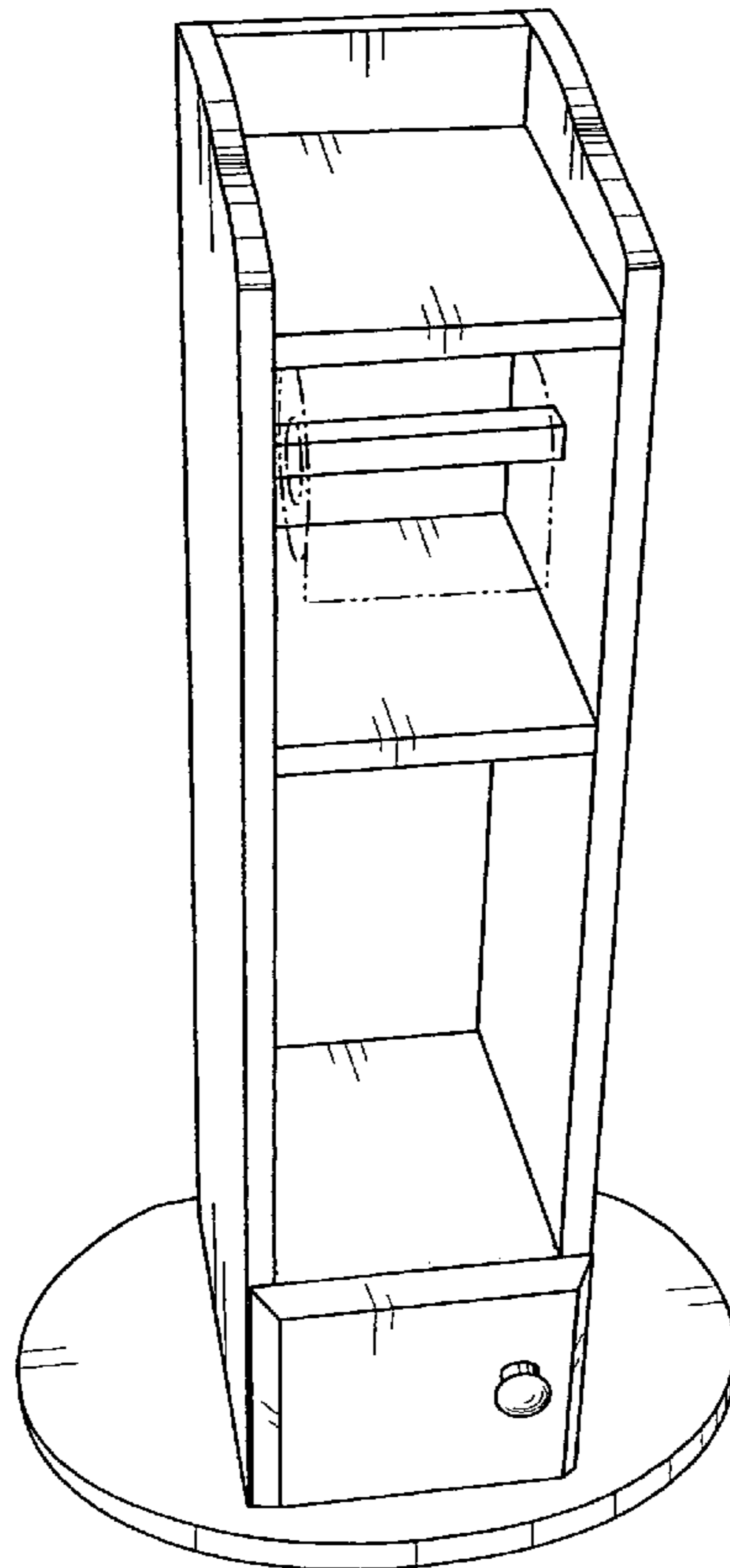

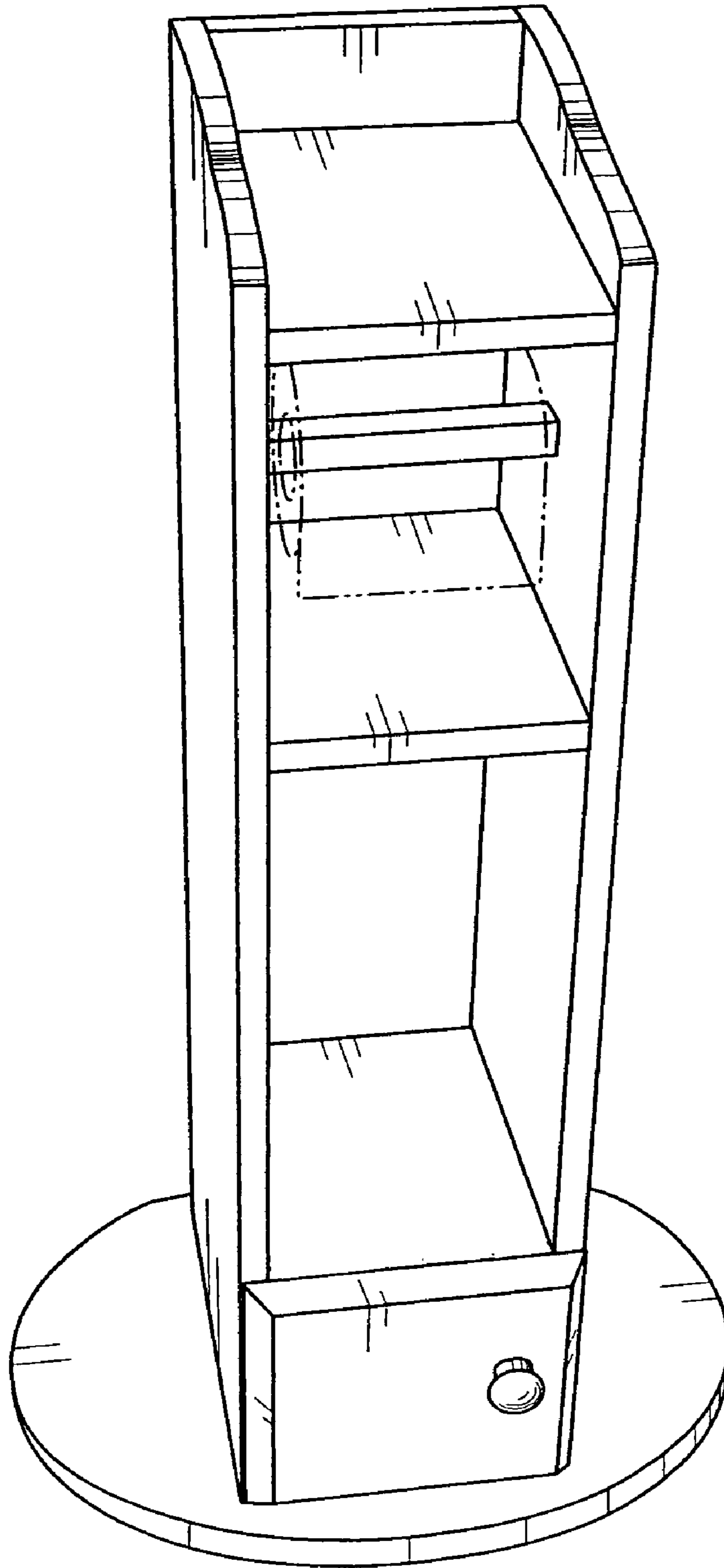

Fig. 1

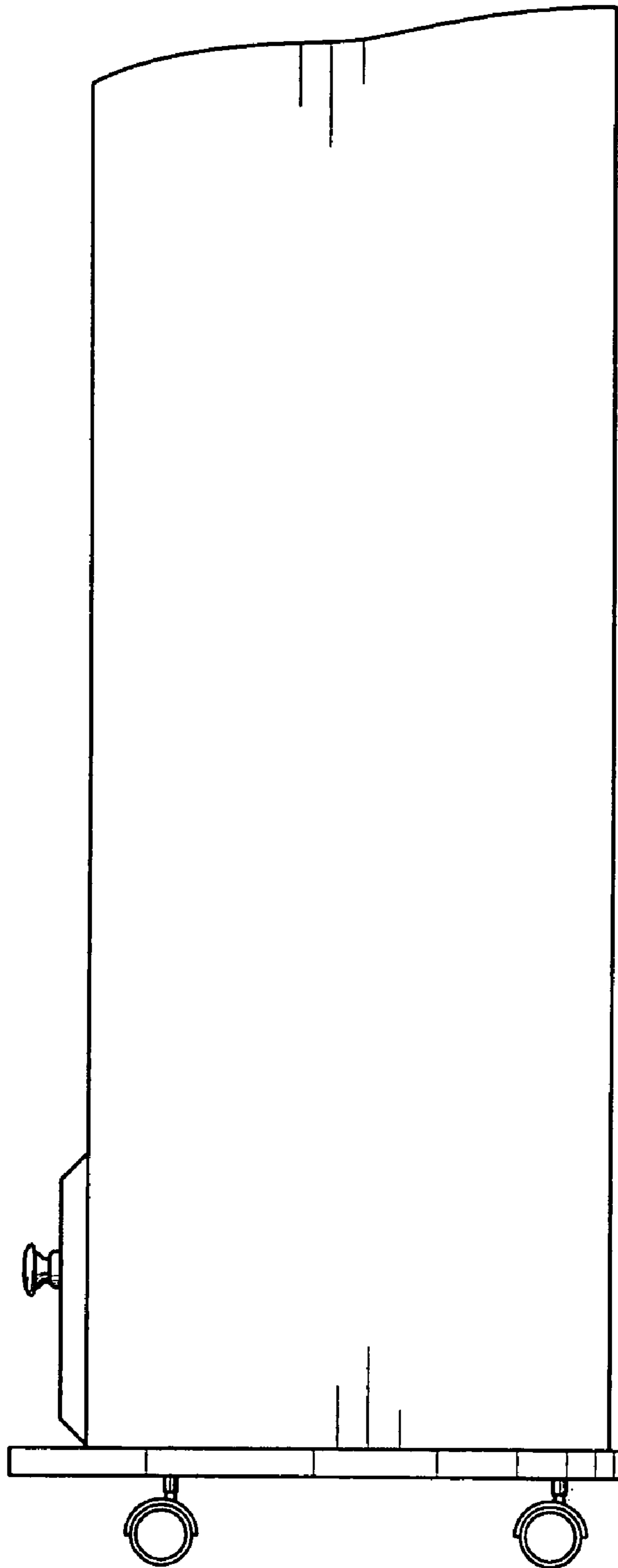

Fig. 2

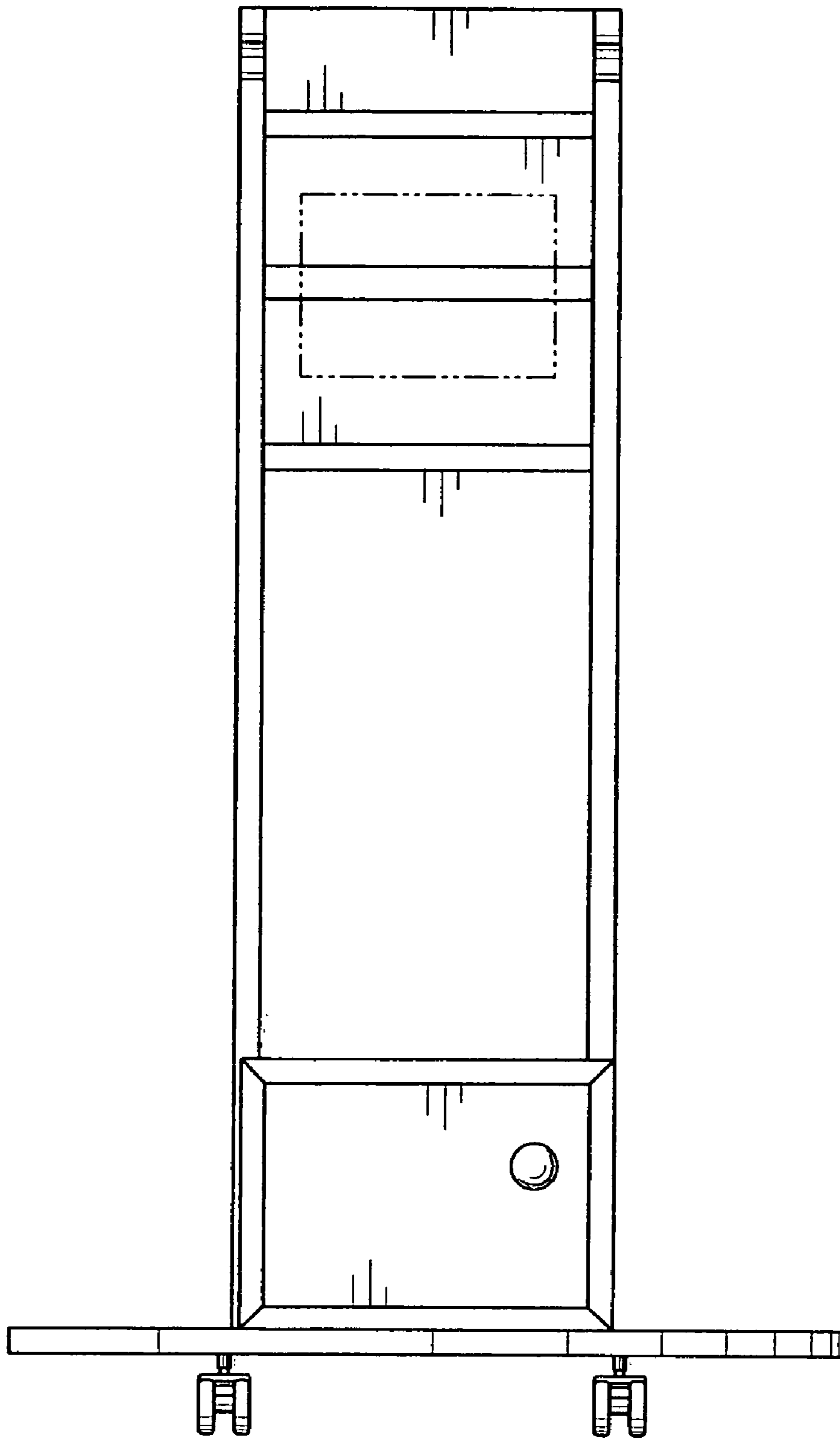

Fig. 3

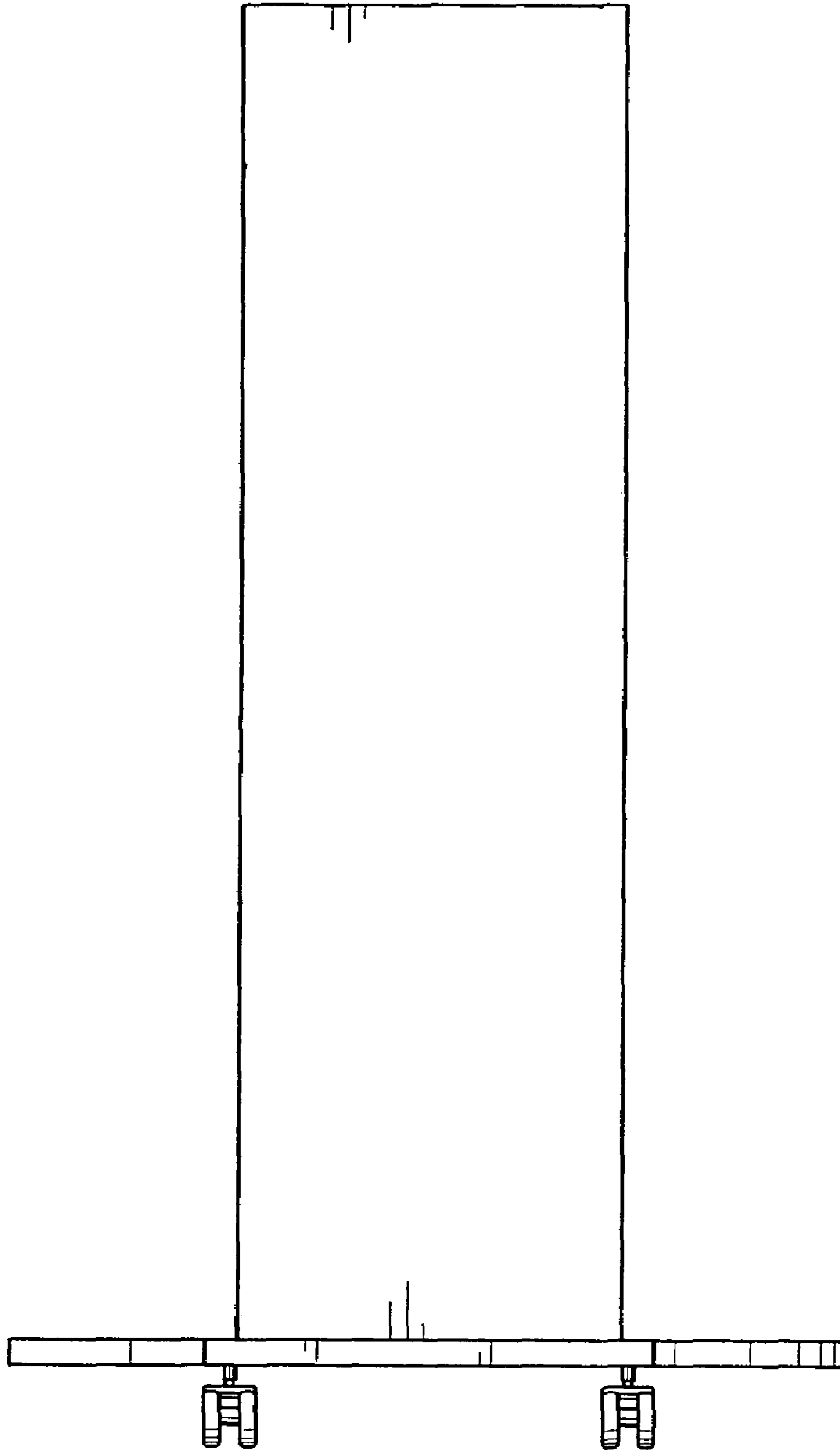

Fig. 4

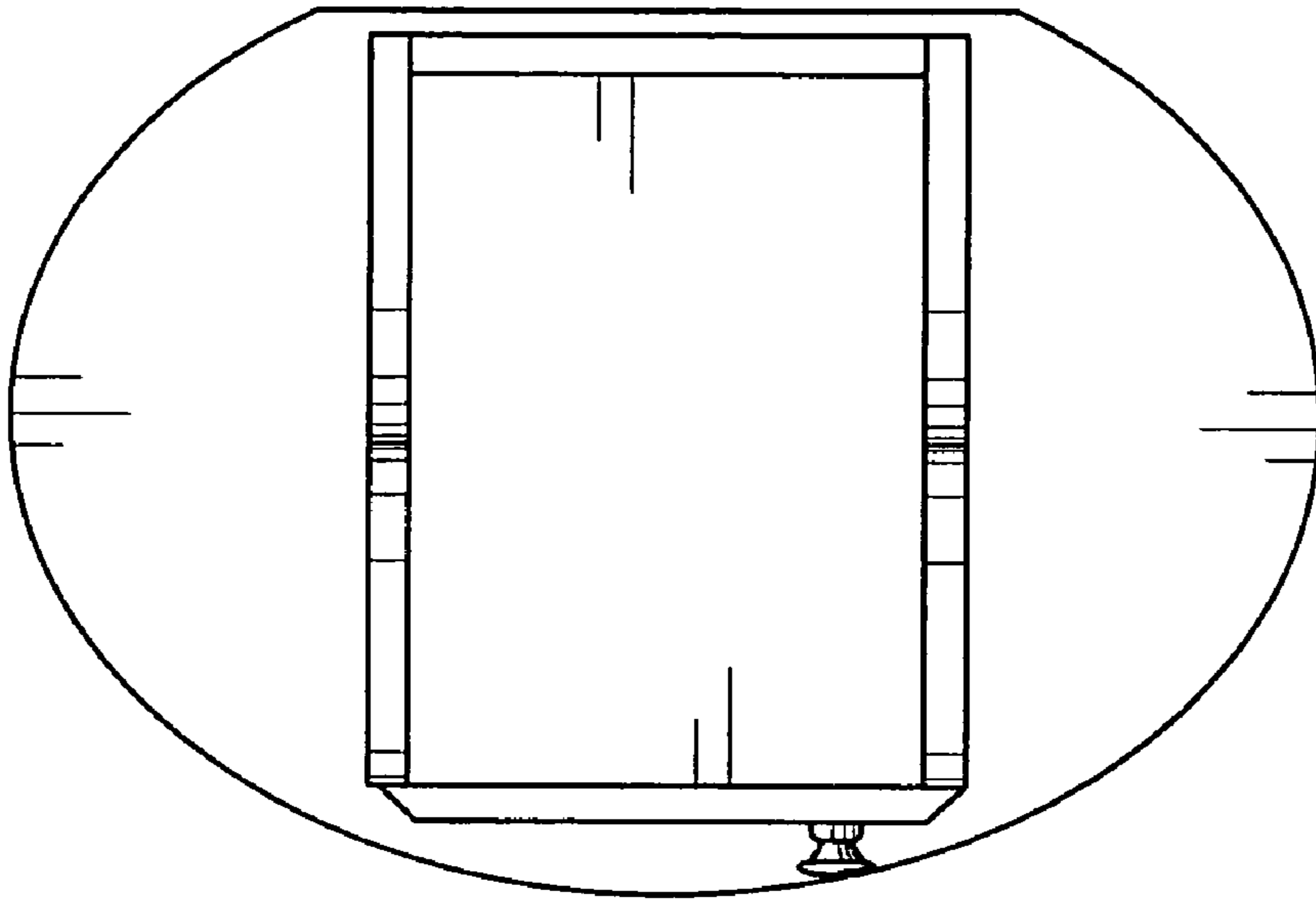

Fig. 5

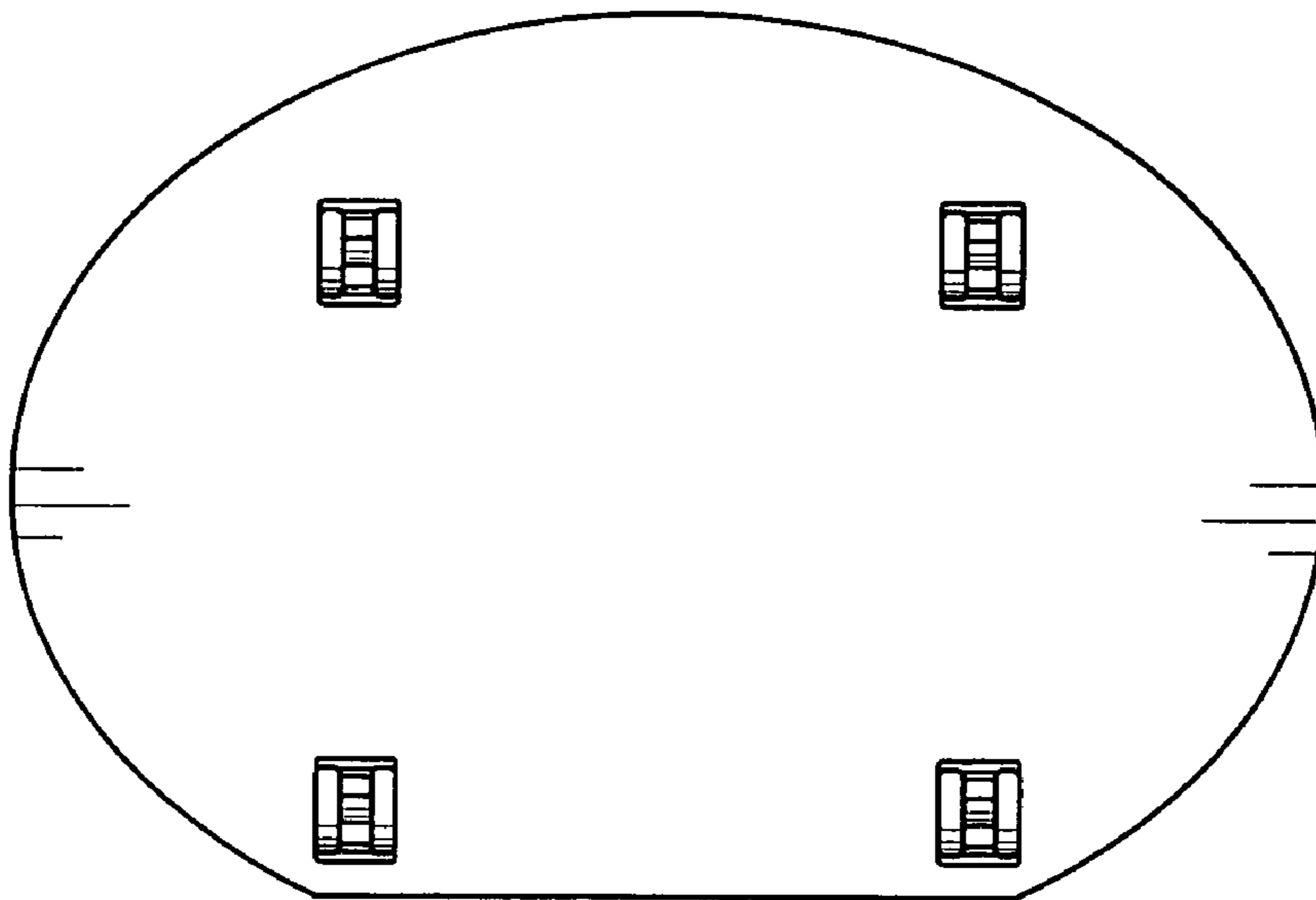

Fig. 6