



US00D547945S

(12) **United States Design Patent**
Gonzalez

(10) **Patent No.:** **US D547,945 S**

(45) **Date of Patent:** **** Aug. 7, 2007**

(54) **HANDBAG**

5,287,903 A 2/1994 Ambasz
D502,805 S 3/2005 Gonzalez
D525,425 S * 7/2006 Gerbi D3/246

(75) Inventor: **Alvaro Gonzalez**, Florence (IT)

(73) Assignee: **J. Choo Limited**, London (GB)

(**) Term: **14 Years**

(21) Appl. No.: **29/249,890**

(22) Filed: **Oct. 25, 2006**

FOREIGN PATENT DOCUMENTS

JP 2002-142829 5/2002

OTHER PUBLICATIONS

Balenciaga, Handbag, printed from <http://www.styledrops.com/handbags-15435.html> on Sep. 20, 2006.

Miu Miu, Handbag, printed from <http://www.styledrops.com/handbags-14731.html> on Sep. 20, 2006.

Related U.S. Application Data

(63) Continuation of application No. 29/255,758, filed on Mar. 9, 2006.

(51) **LOC (8) Cl.** **03-01**

(52) **U.S. Cl.** **D3/243**

(58) **Field of Classification Search** D3/232,
D3/234, 238, 240, 241, 242, 243, 244, 245,
D3/246, 303, 318, 319, 321, 322, 323, 324,
D3/325, 326, 900, 902; 150/100, 107, 108,
150/110, 111, 118, 119, 120; 190/100, 108,
190/109, 112, 115, 900, 902, 903; 383/31,
383/38, 42, 70, 71, 72, 74, 75, 76, 78, 84,
383/117, 907, 6, 25, 30

See application file for complete search history.

(Continued)

Primary Examiner—Louis S. Zarfes

Assistant Examiner—Monica A. Weingart

(74) *Attorney, Agent, or Firm*—Fross Zelnick Lehrman & Zissu, PC; Charles T. J. Weigell, Esq

(57) **CLAIM**

The ornamental design for a handbag, as shown and described.

DESCRIPTION

FIG. 1 is a front perspective view of a handbag showing my handbag design;

FIG. 2 is a front view of the handbag shown in FIG. 1;

FIG. 3 is a rear view of the handbag shown in FIG. 1;

FIG. 4 is a left side view of the handbag shown in FIG. 1;

FIG. 5 is a right side view of the handbag shown in FIG. 1;

FIG. 6 is a top view of the handbag shown in FIG. 1; and,

FIG. 7 is a bottom view of the handbag shown in FIG. 1.

The broken line showing of portions of the handles, portion of the straps, strap loop, buckle, portion of the handbag, closure flap, central clasp, and rivets is for illustrative purposes only and forms no part of the claimed design.

(56) **References Cited**

U.S. PATENT DOCUMENTS

708,234 A * 9/1902 Laird 383/76
931,627 A 8/1909 Lazarovich-Hrebelian
1,186,590 A * 6/1916 McIlvaine 383/71
D118,076 S 12/1939 Murphy
D136,593 S 11/1943 Phelps
D171,520 S * 2/1954 Spradling D3/244
2,832,116 A * 4/1958 Clevett, Jr. et al. 383/76
D219,119 S 11/1970 Marshall
D220,414 S 4/1971 Marshall
D281,201 S 11/1985 Schimmel
D326,016 S 5/1992 Guaresi
D333,565 S 3/1993 Imbert

1 Claim, 7 Drawing Sheets

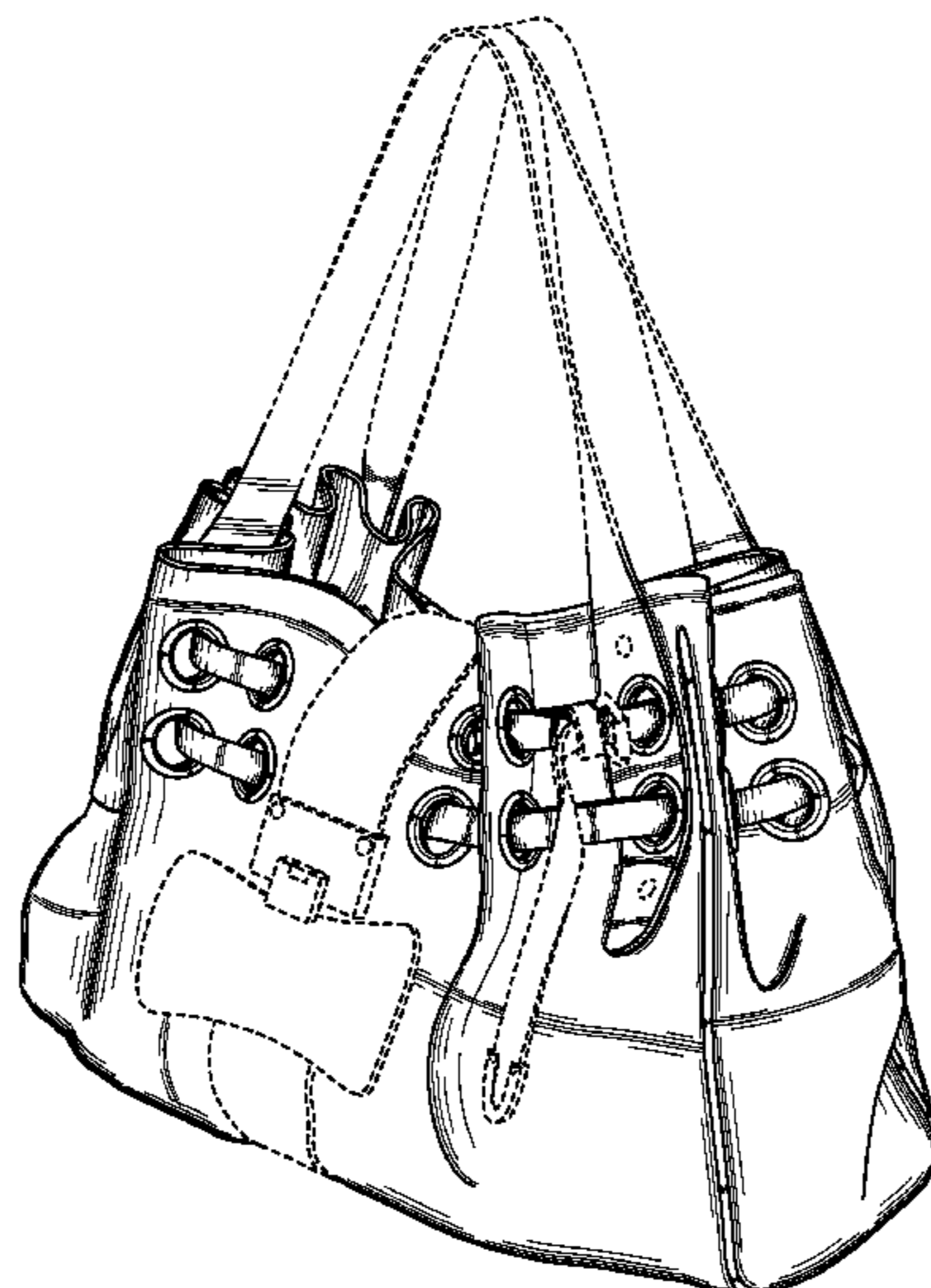

OTHER PUBLICATIONS

PRADA, Handbag, printed from <http://www.styledrops.com/handbags-11983.html> on Sep. 20, 2006.

PRADA, Handbag, printed from <http://www.styledrops.com/handbags-14467.html> on Sep. 20, 2006.

PRADA, Handbag, printed from <http://www.styledrops.com/handbags-14196.html> on Sep. 20, 2006.

PRADA, Handbag, printed from <http://www.styledrops.com/handbags-15012.html> on Sep. 20, 2006.

Mari Max, "High Park Jackie" Shoulder bag, printed from <http://www.marimaxssi.com/handbags4.html>, Sep. 19, 2006.

Handmade Extraordinary Accessories, Handbags, printed from <http://www.handmadenyc.com/handbags.html>, on Sep. 19, 2006.

DIOR, "Cannage Large Shopper" handbag, printed from http://www.eluxury.com/browse/product_detail.jhtml?SectionID=9000&styleid=11222549; printed on Sep. 2, 2006.

PRADA, Black Nylon and Letter Handbag, printed from <http://www.ashford.com/> on Sep. 7, 2006.

J. Renee, "Destin/Emory" Handbag, printed from <http://www.zap-pos.com/n/p/dp/16211489/c/17.html> on Sep. 7, 2006.

Overlimit Co. Ltd., Handbag, printed from <http://overlimitz.en.alibaba.com/> on Sep. 2, 2006.

Elliot Lucca, "Winona" Drawstring bag, printed from http://shop.nordstrom.com/c/2383730/0~2376779~2374605~2383730?origin=6002309_Select+a+Brand6002309, on Sep. 27, 2006.

J. Choo (Jersey) Limited, Tulita Hobo Large, Spring/Summer 2004 Catalogue.

U.S. Appl. No. 29/238,642, filed Sep. 19, 2005.

U.S. Appl. No. 29/243,045, filed Nov. 17, 2005.

U.S. Appl. No. 29/255,773, filed Mar. 9, 2006.

U.S. Appl. No. 29/251,896, filed Jan. 12, 2006.

U.S. Appl. No. 29/263,299, filed Jul. 19, 2006.

U.S. Appl. No. 29/263,034, filed Jul. 14, 2006.

U.S. Appl. No. 29/263,281, filed Jul. 19, 2006.

Vintage Bag with Ring, undated photograph.

"New 'it' Bag!," Ramona handbag, People Magazine, Spring 2006.

* cited by examiner

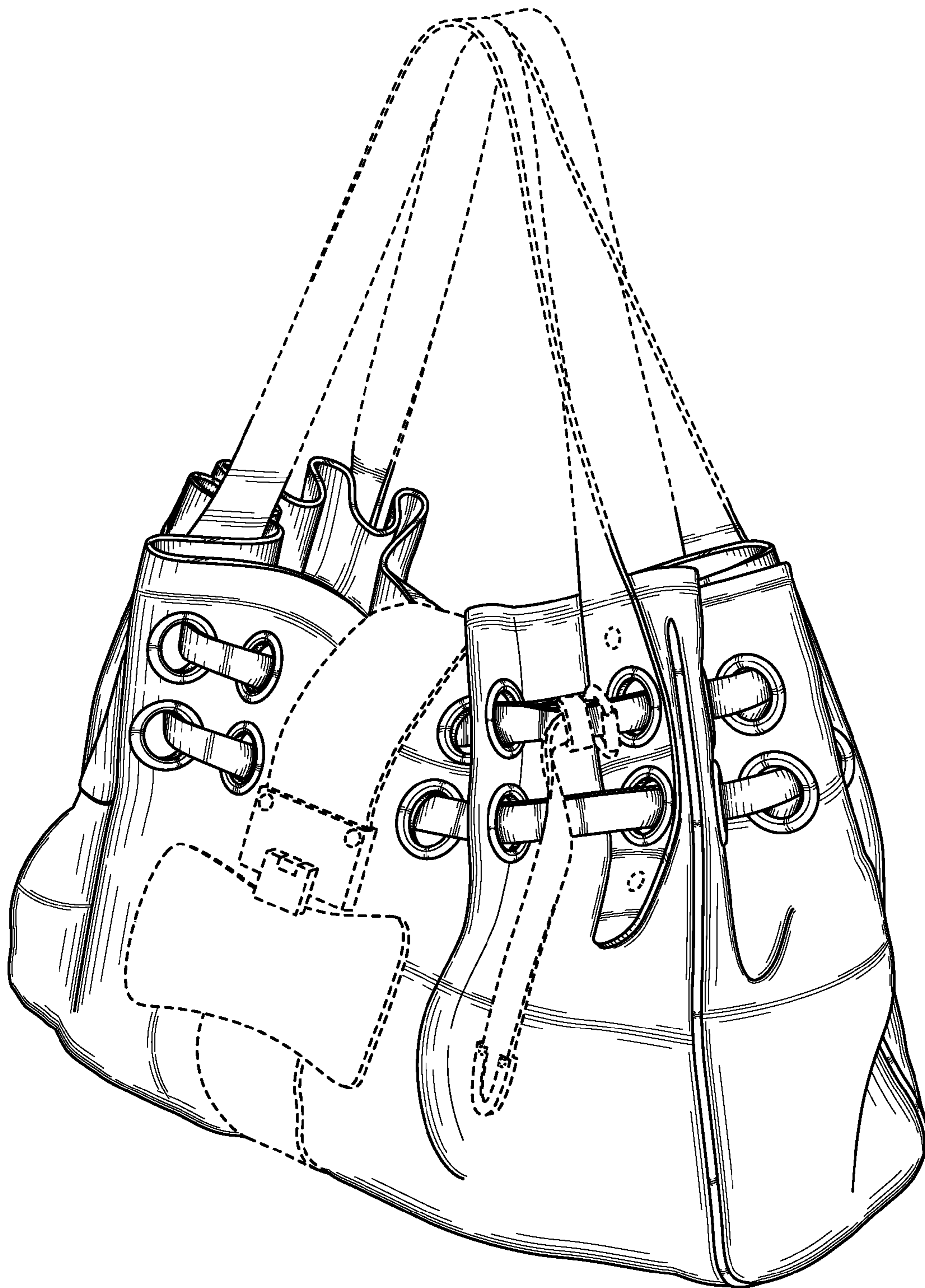

FIG. 1

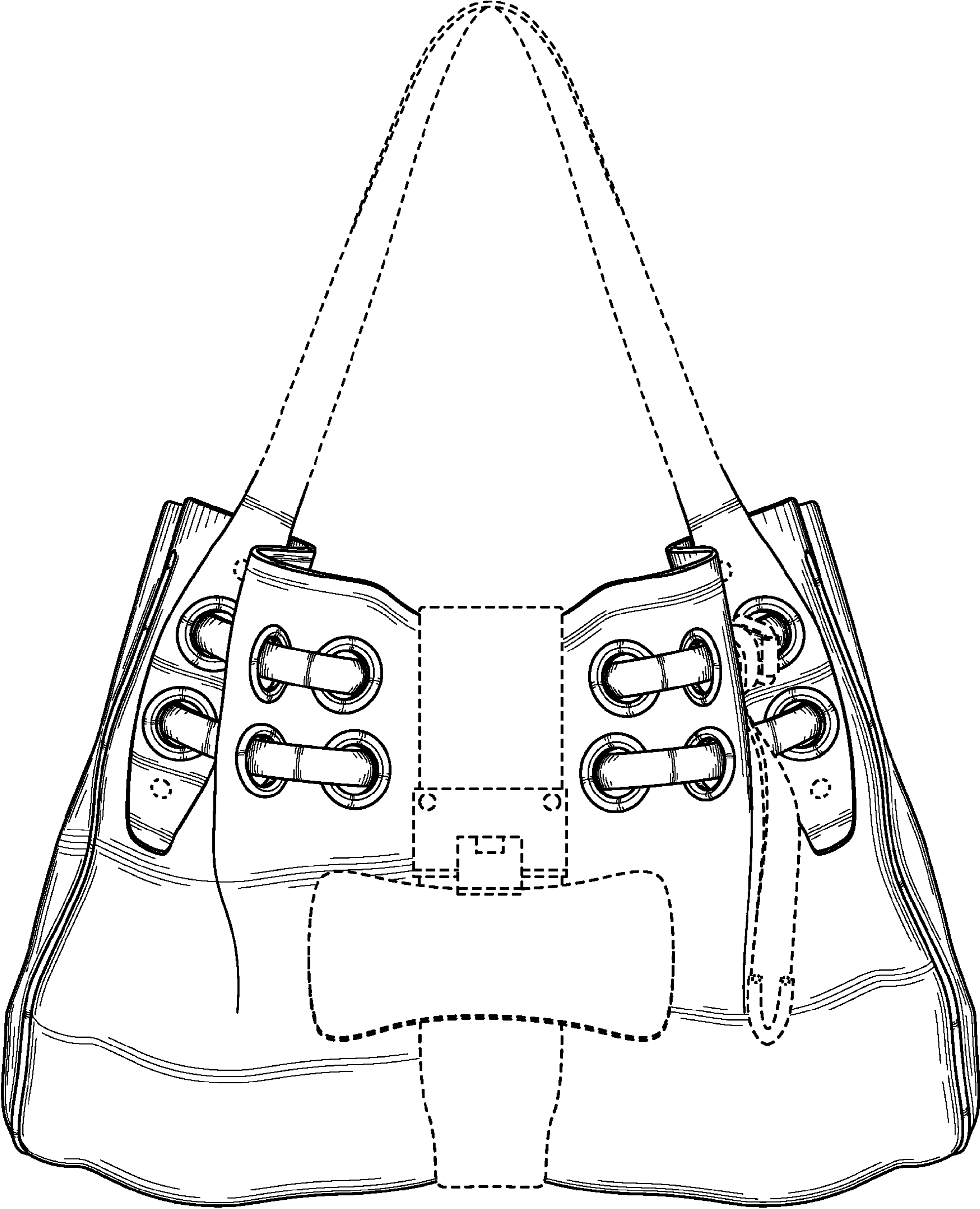

FIG. 2

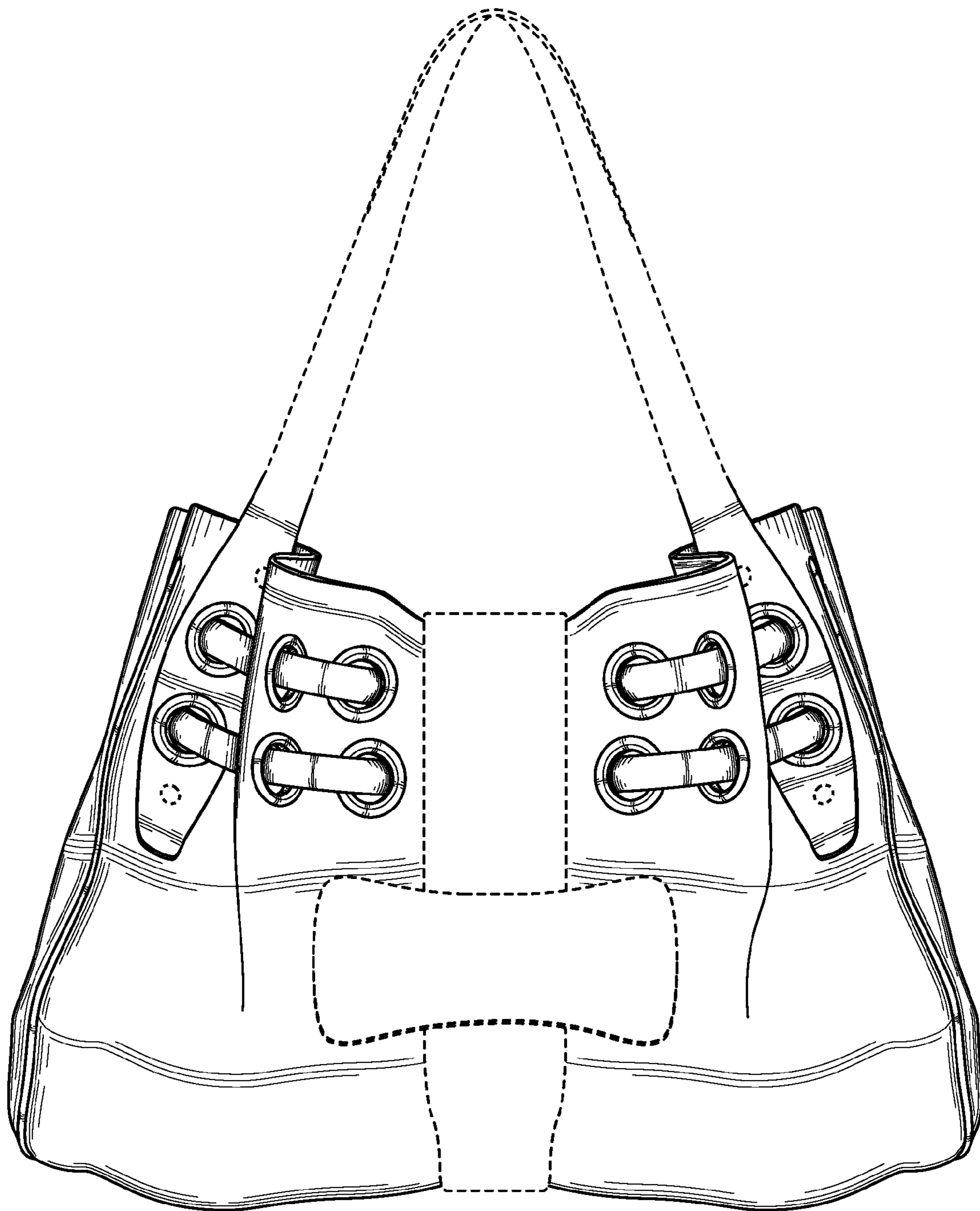

FIG. 3

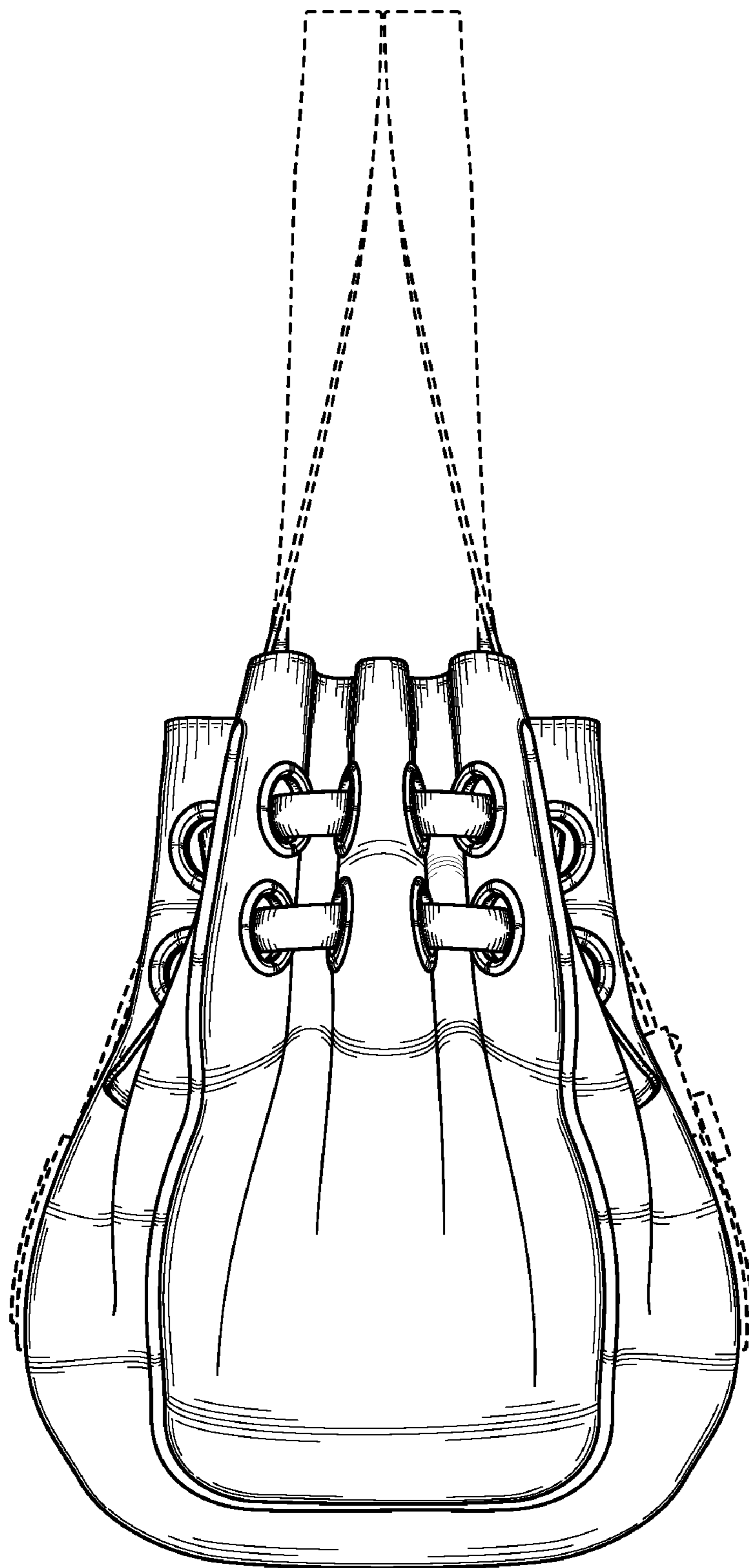

FIG. 4

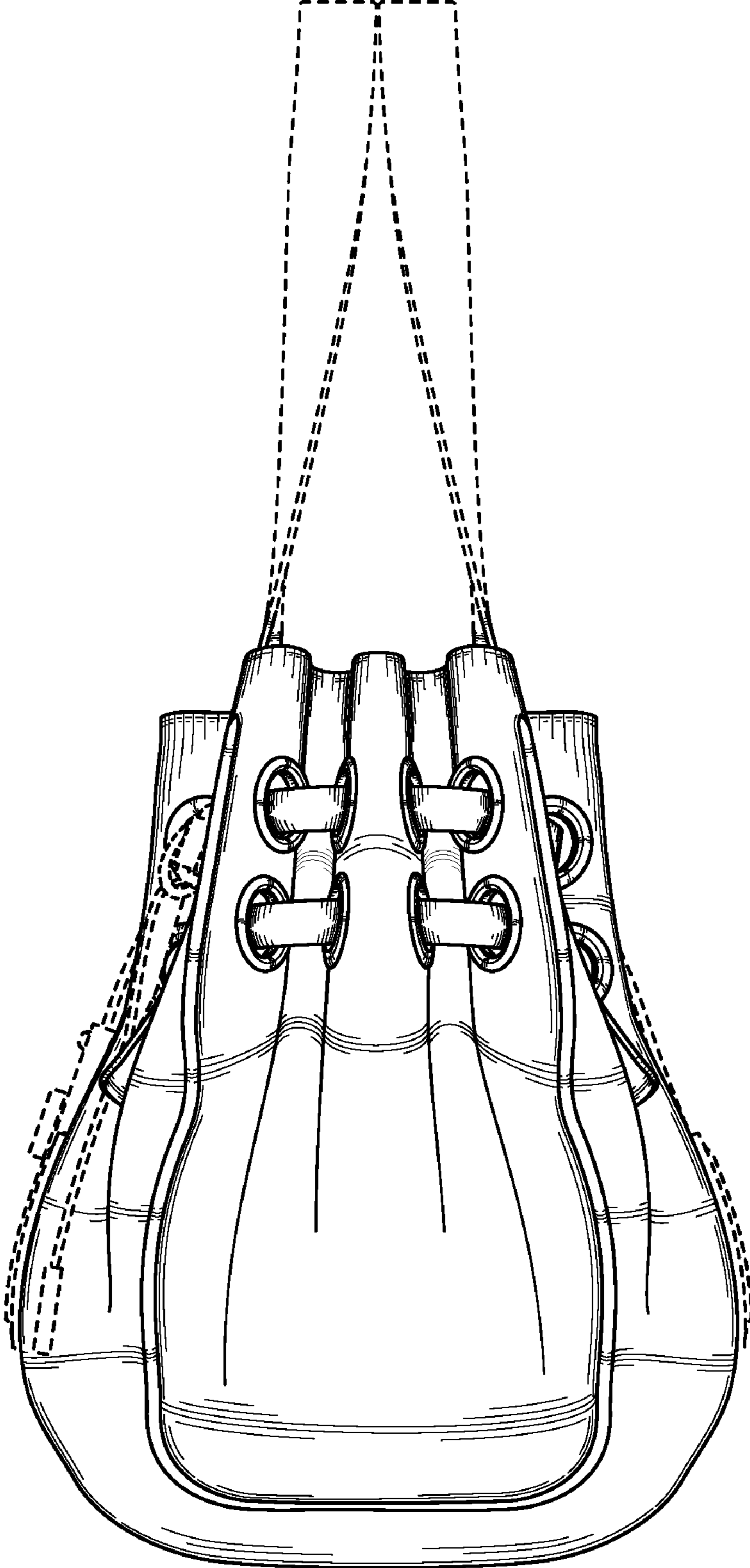

FIG. 5

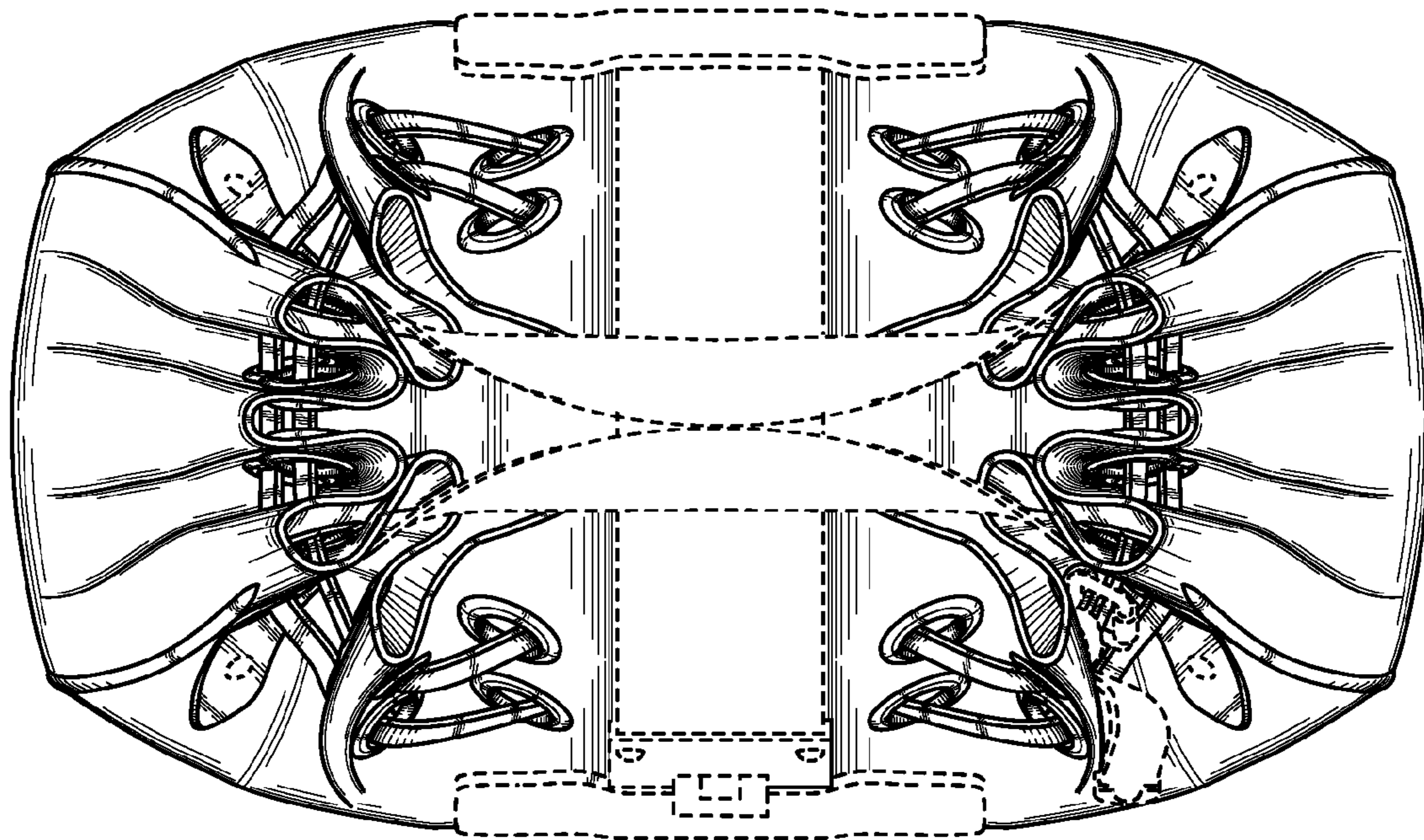

FIG. 6

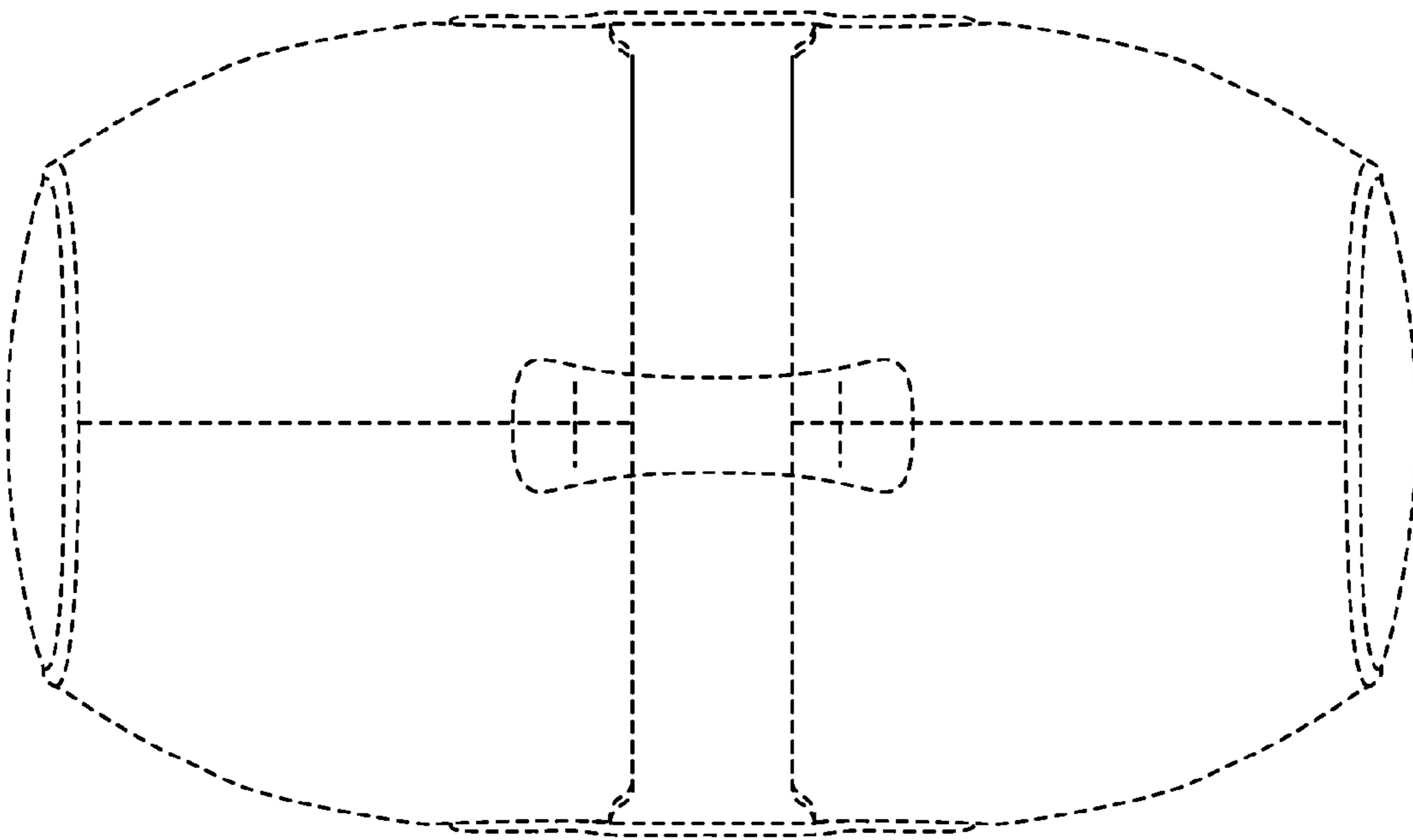

FIG. 7