

US00D547944S

(12) **United States Design Patent**
Gonzalez

(10) **Patent No.:** **US D547,944 S**

(45) **Date of Patent:** **** Aug. 7, 2007**

(54) **HANDBAG**

(75) Inventor: **Alvaro Gonzalez**, Florence (IT)

(73) Assignee: **J. Choo Limited**, London (GB)

(**) Term: **14 Years**

(21) Appl. No.: **29/271,537**

(22) Filed: **Jan. 22, 2007**

1,186,590 A * 6/1916 McIlvaine 383/71
D171,520 S * 2/1954 Sprading D3/244
2,832,116 A * 4/1958 Clevett, Jr. et al. 24/30.5 R
D525,425 S * 7/2006 Gerbi D3/246

* cited by examiner

Primary Examiner—Louis S. Zarfes

Assistant Examiner—Michelle E. Wilson

(74) *Attorney, Agent, or Firm*—Fross Zelnick Lehrman & Zissu, P.C.; Lawrence E. Apolzon, Esq.; Charles T. J. Weigell, Esq.

Related U.S. Application Data

(62) Division of application No. 29/255,758, filed on Mar. 9, 2006.

Foreign Application Priority Data

Sep. 9, 2005 (EM) 000401484-0015

(51) **LOC (8) Cl.** **03-01**

(52) **U.S. Cl.** **D3/232**

(58) **Field of Classification Search** D3/232,
D3/234, 238, 240, 241, 242, 243, 244–246,
D3/303, 318–319, 321–326, 900–902; 150/100,
150/107, 108, 110, 111, 118, 119, 120; 190/100,
190/108

See application file for complete search history.

(56) **References Cited**

U.S. PATENT DOCUMENTS

708,234 A * 9/1902 Laird 383/26

(57) **CLAIM**

The ornamental design for a handbag, as shown and described.

DESCRIPTION

FIG. 1 is a front perspective view of a handbag showing my handbag design;

FIG. 2 is a front view of the handbag shown in FIG. 1;

FIG. 3 is a rear view of the handbag shown in FIG. 1;

FIG. 4 is a left side view of the handbag shown in FIG. 1;

FIG. 5 is a right side view of the handbag shown in FIG. 1;

FIG. 6 is a top view of the handbag shown in FIG. 1; and,

FIG. 7 is a bottom view of the handbag shown in FIG. 1.

The broken line showing of the handles, is for illustrative purposes only and forms no part of the claimed design.

1 Claim, 7 Drawing Sheets

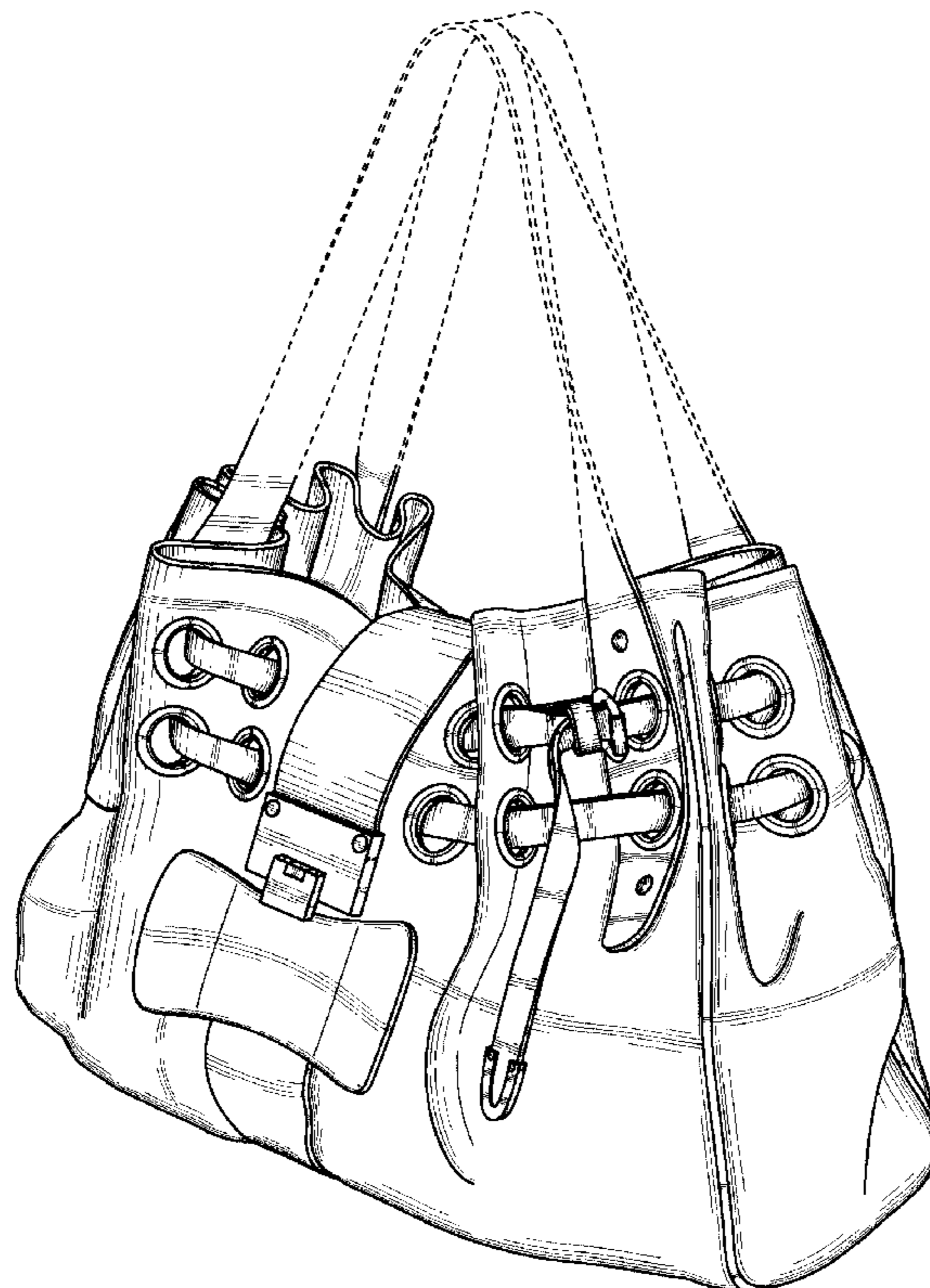

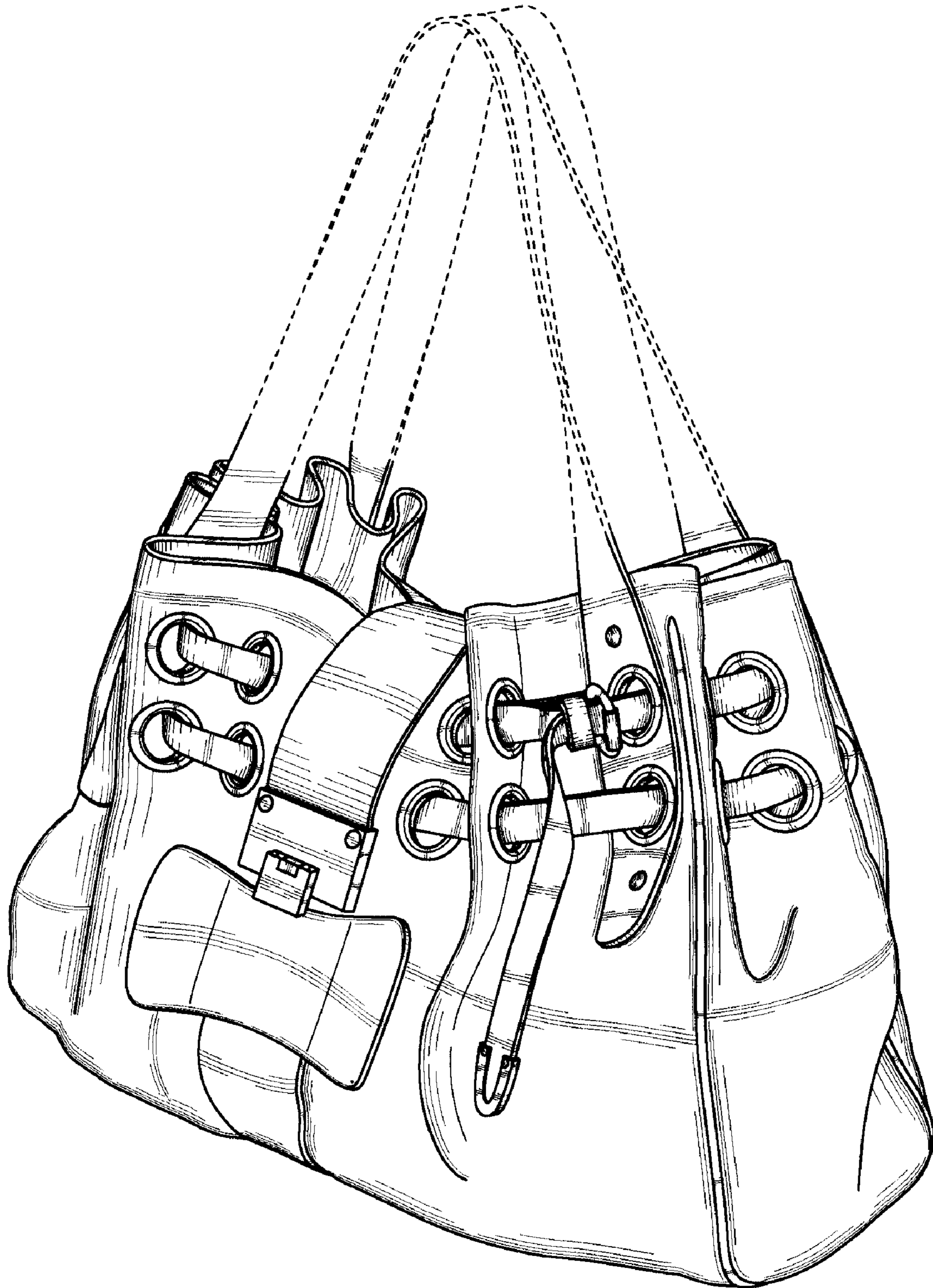

FIG. 1

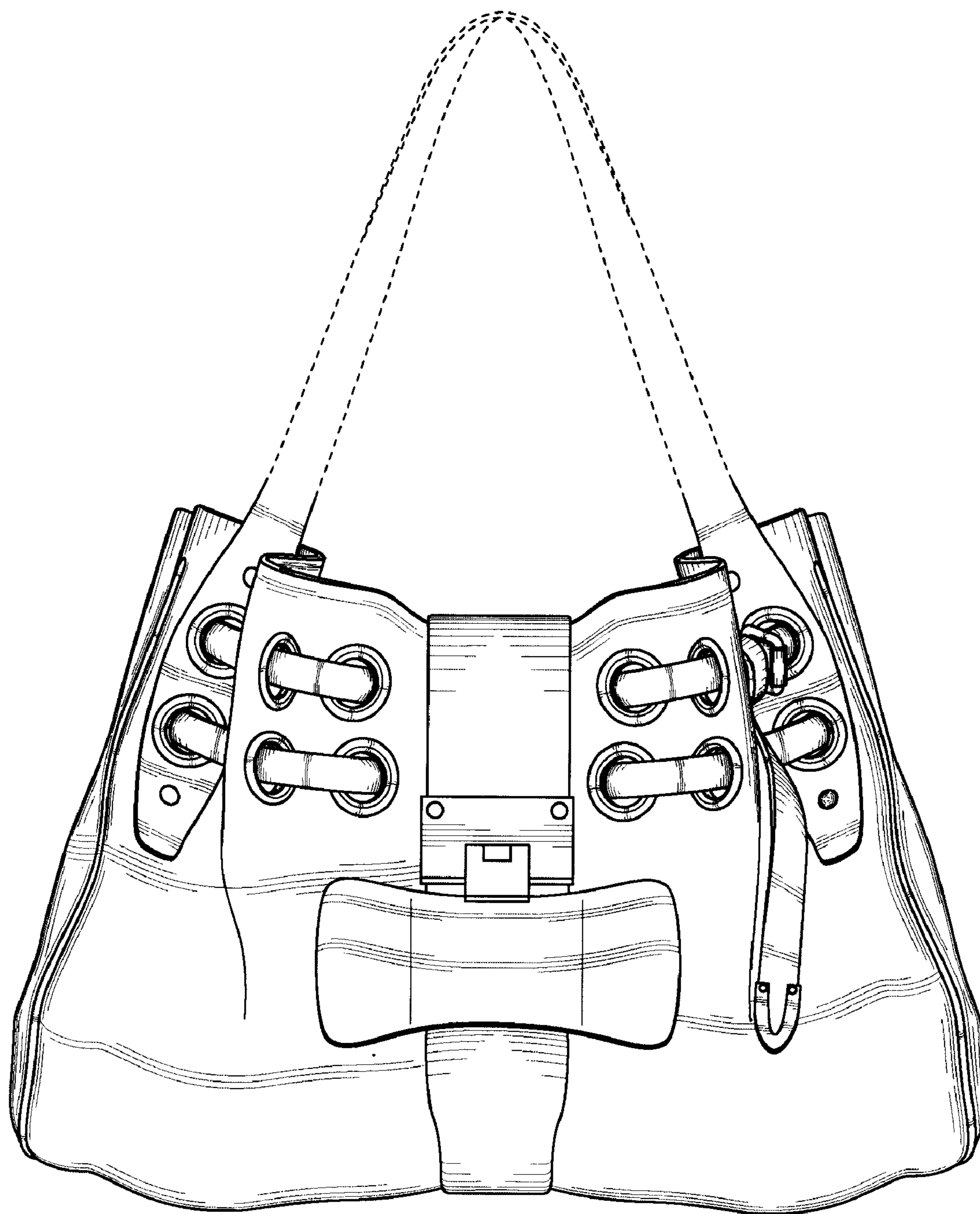

FIG. 2

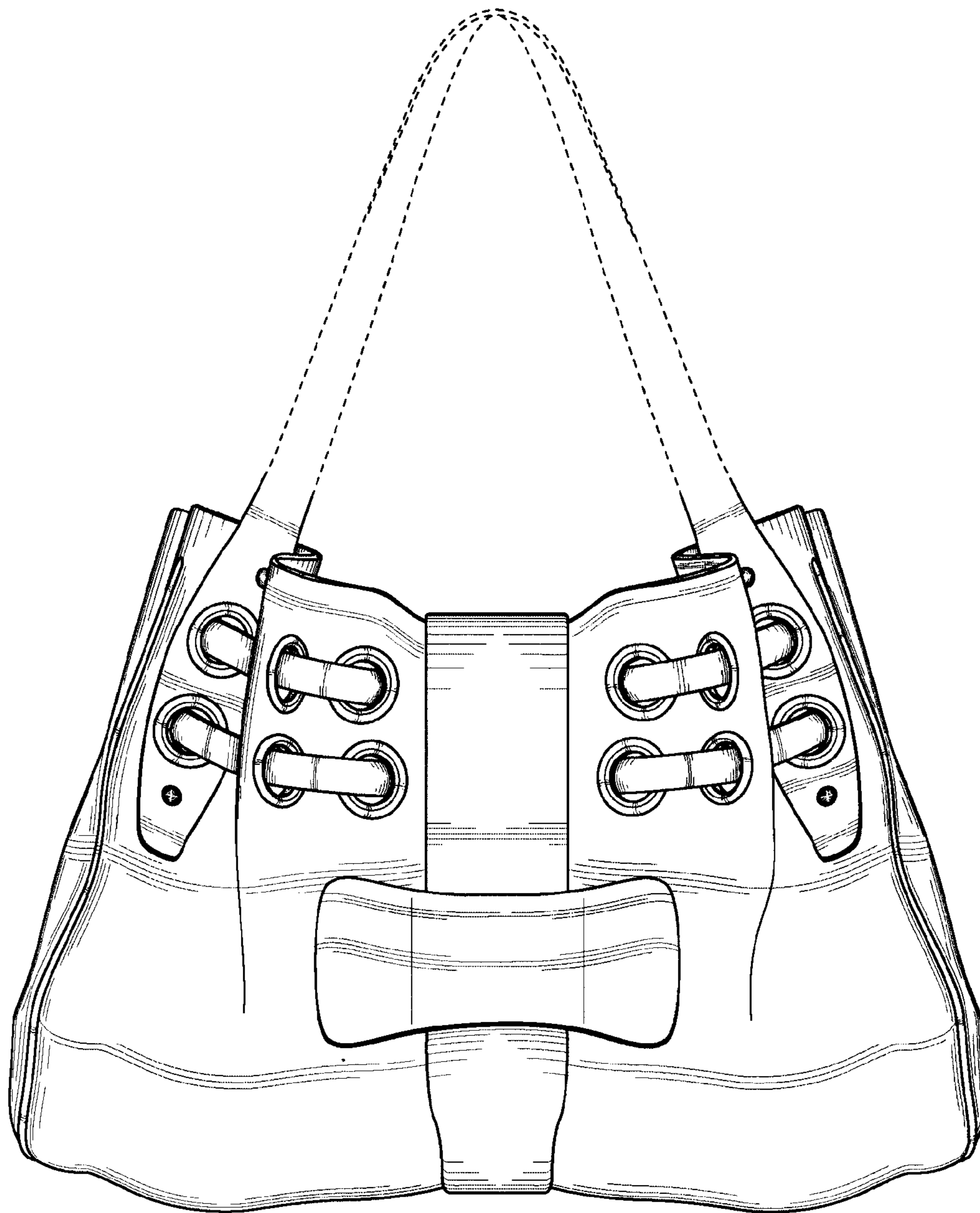

FIG. 3

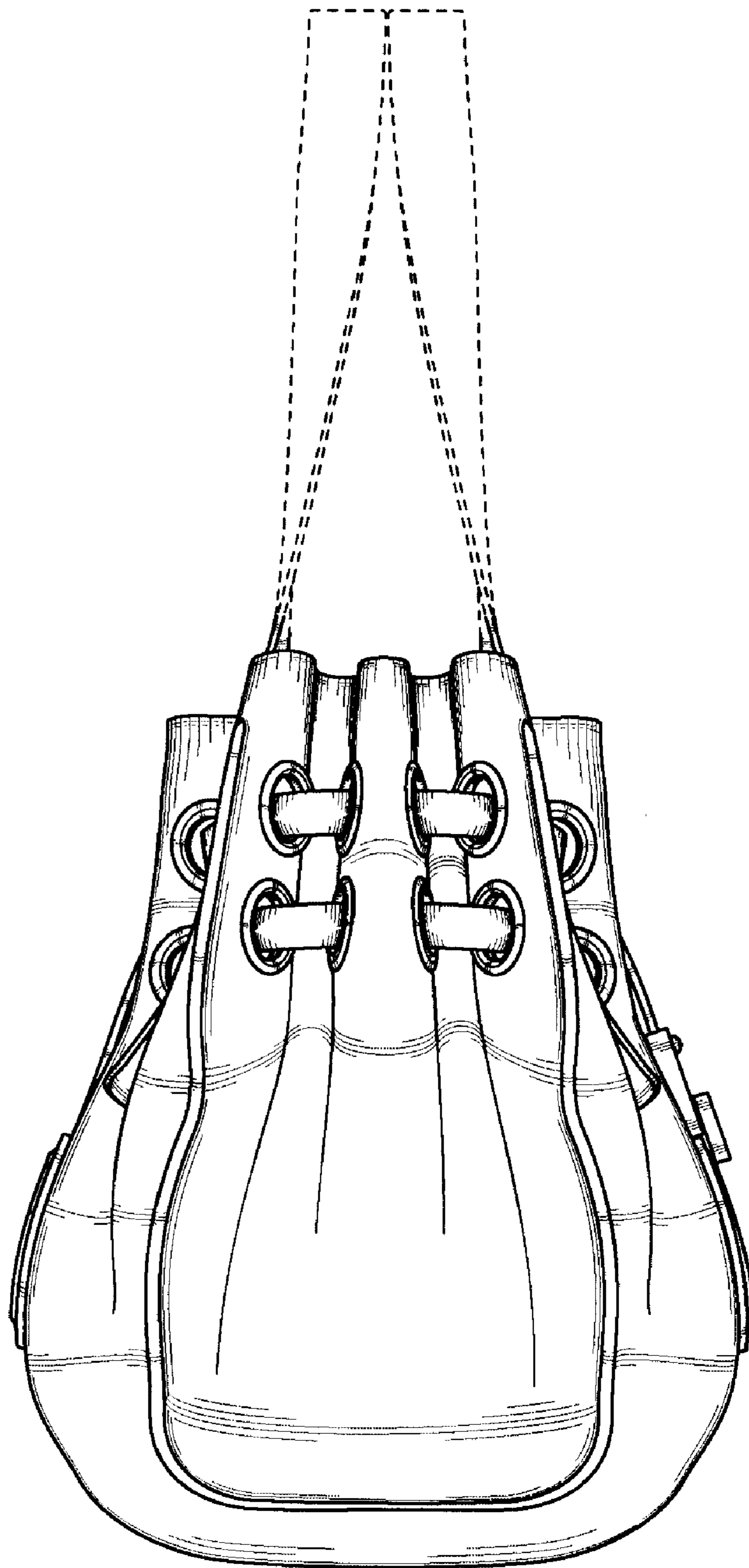

FIG. 4

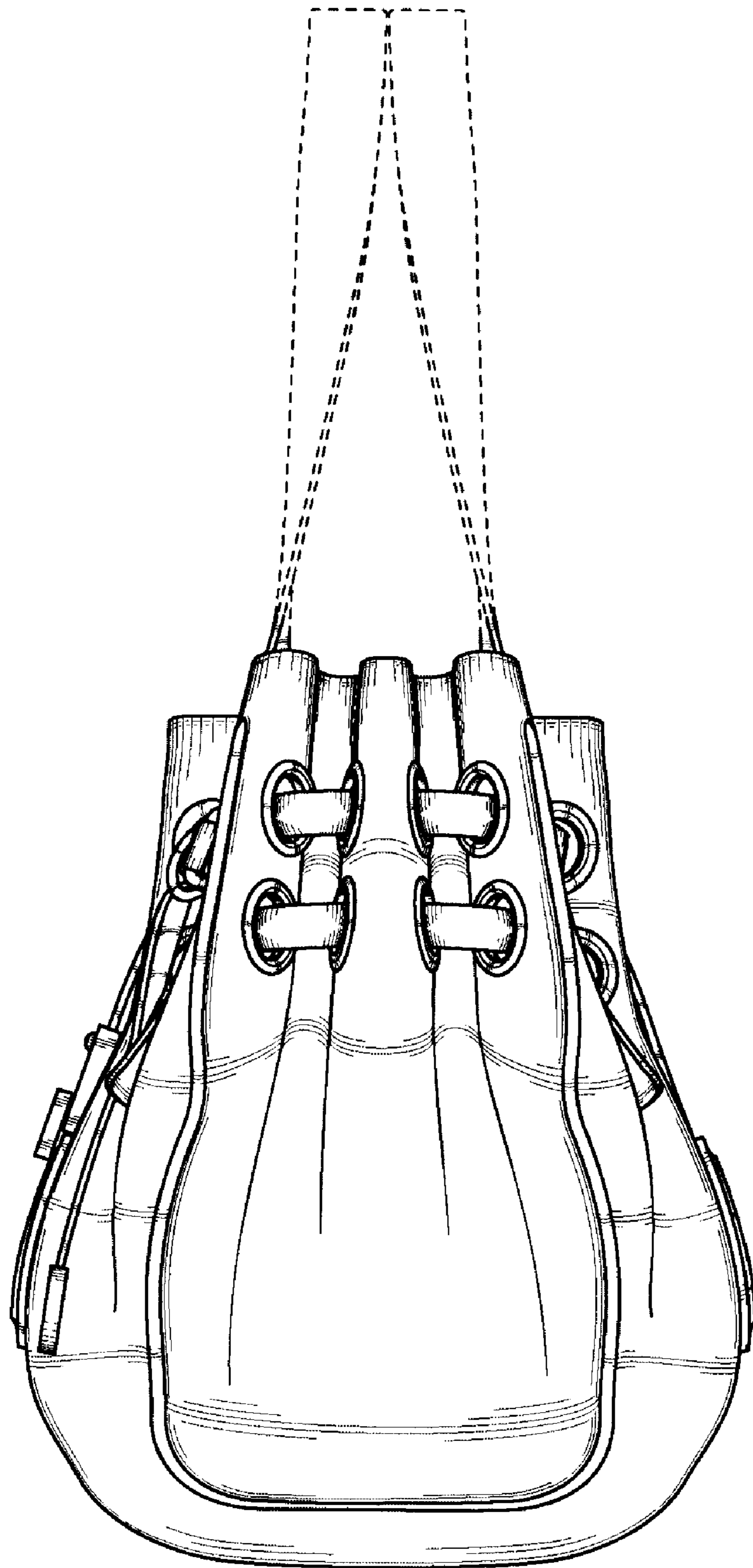

FIG. 5

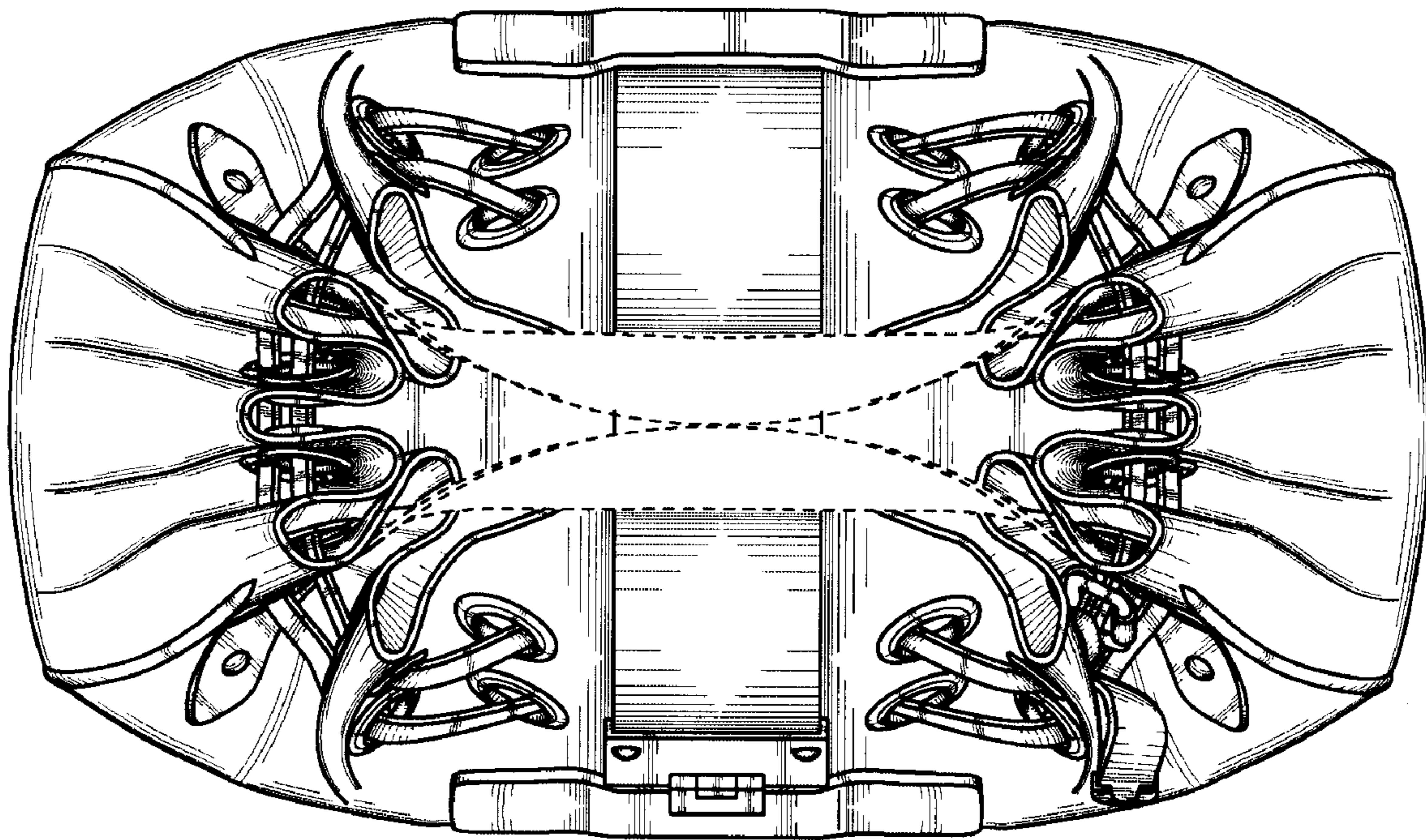

FIG. 6

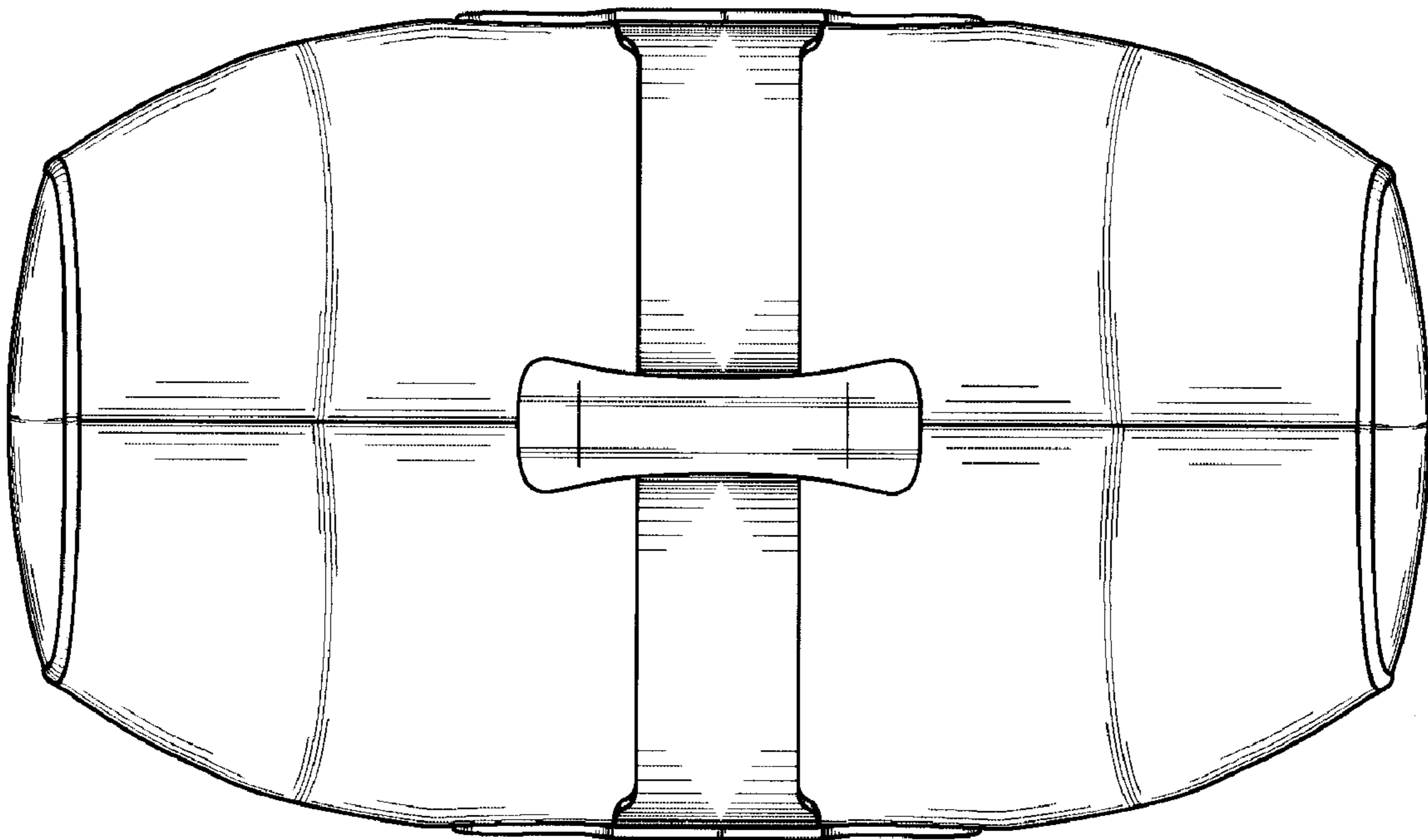

FIG. 7