

US00D547841S

(12) **United States Design Patent**
Ziemann

(10) **Patent No.:** **US D547,841 S**

(45) **Date of Patent:** **** Jul. 31, 2007**

- (54) **SINK**
- (75) Inventor: **Brigitte Ziemann**, Eppingen (DE)
- (73) Assignee: **Blanco GmbH + Co KG** (DE)
- (**) Term: **14 Years**
- (21) Appl. No.: **29/242,608**
- (22) Filed: **Nov. 10, 2005**
- (30) **Foreign Application Priority Data**
May 11, 2005 (EM) 000344775
- (51) **LOC (8) Cl.** **23-02**
- (52) **U.S. Cl.** **D23/293.1**
- (58) **Field of Classification Search** D23/270–273,
D23/284–287, 289, 291–293.1, 303, 308;
4/619, 630–631, 637, 661; D21/524
See application file for complete search history.

(56) **References Cited**

U.S. PATENT DOCUMENTS

2,846,695	A *	8/1958	Hartog	4/633
4,039,077	A	8/1977	Sorenson	
4,584,822	A	4/1986	Fielding et al.	
5,199,119	A *	4/1993	Weber	4/619
D354,119	S *	1/1995	Hauser, II	D23/284
5,653,550	A	8/1997	Mutz et al.	
5,860,172	A	1/1999	Pfeiffer	
RE37,253	E	7/2001	Moren et al.	
6,308,351	B1	10/2001	Franke	
6,382,422	B1	5/2002	Bocek	
D494,664	S *	8/2004	Arnold	D23/293.1
D508,555	S	8/2005	Ziemann	
D518,881	S	4/2006	Ziemann	
2003/0041374	A1	3/2003	Franke	
2004/0078892	A1	4/2004	Albarran	
2005/0205193	A1	9/2005	Von Mertz	
2005/0263427	A1	12/2005	Schneider et al.	

FOREIGN PATENT DOCUMENTS

DE	1920893	A	11/1970
DE	1628684		12/1970

DE	2640935	A1	3/1977
DE	2813088	A	10/1979
DE	7820319	U1	12/1979
DE	3 110 134		10/1982
DE	3925590	A	2/1991
DE	4241023	A	6/1994
DE	4437630		1/1996
DE	29620839	U1	3/1997
DE	29822399	U1	4/1999
EP	0685021	B1	12/1995
EP	0 709 528		5/1996
EP	0 976 881		2/2000
EP	1 103 665		5/2001
EP	1188685	A2	3/2002
FR	1319427		3/1963
FR	2430532		7/1979

(Continued)

OTHER PUBLICATIONS

European Patent Office Search Report for European Patent Application No. 04 012 865.4, Nov. 3, 2004 (3 pages).

(Continued)

Primary Examiner—Robert A. Delehanty
(74) *Attorney, Agent, or Firm*—Hanley, Flight & Zimmerman, LLC

(57) **CLAIM**

The ornamental design for a “sink,” as shown and described.

DESCRIPTION

FIG. 1 is a top, left perspective view of a sink showing my new design.

FIG. 2 is a top plan view of the sink of FIG. 1.

FIG. 3 is a bottom plan view of the sink of FIG. 1.

FIG. 4 is a front view of the sink of FIG. 1.

FIG. 5 is a rear view of the sink of FIG. 1.

FIG. 6 is a right side view of the sink of FIG. 1; and,

FIG. 7 is a left side view of the sink of FIG. 1.

1 Claim, 7 Drawing Sheets

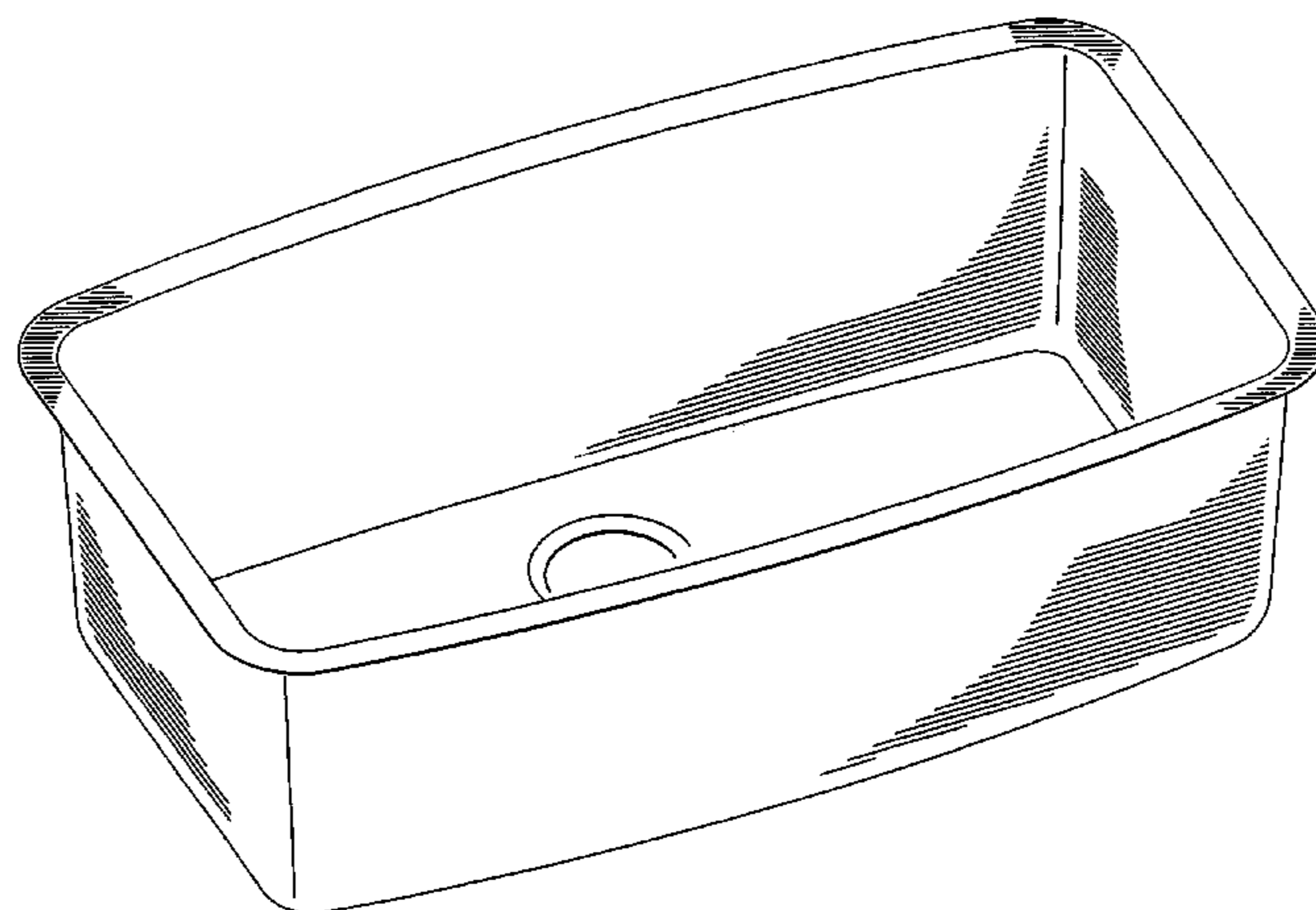

FOREIGN PATENT DOCUMENTS

FR	2 832 440	5/2003
GB	2108195 A	5/1983
GB	2263060 A	7/1993
JP	63272682	11/1988
JP	10029684	2/1998
NL	8201555	11/1983

OTHER PUBLICATIONS

European Patent Office Search Report for European Patent Application No. 04 012 866.2, Nov. 12, 2004 (3 pages).

International Search Report corresponding to International Application No. PCT/EP2004/012840 (5 pages).

Office action of German Patent Office corresponding to German Application No. 103 55 032.1 (2 pages).

International Search Report corresponding to International Application Serial No. PCT/EP2004/007830, Oct. 5, 2004, 3 pages.

Ziemann, Brigitte, U.S. Appl. No. 29/225,634, filed Mar. 18, 2005 for "Sink."

Schneider, Wolfgang, U.S. Appl. No. 11/140,830, filed May 31, 2005 for "Built-Under Sinks."

Ziemann, Brigitte, U.S. Appl. No. 29/242,599, filed Nov. 10, 2005 for "Sink Performa V2 Big Single."

Ziemann, Brigitte, U.S. Appl. No. 29/242,618, filed Nov. 10, 2005 for "Sink Performa K4 2.0 Small."

Ziemann, Brigitte, U.S. Appl. No. 29/242,607, filed Nov. 10, 2005, for "Sink Performa K4 1.0 Large."

Ziemann, Brigitte, U.S. Appl. No. 29/242,581, filed Nov. 10, 2005, for "Sink Performa K3 30 1.5."

Ziemann, Brigitte, U.S. Appl. No. 29/242,612, filed Nov. 10, 2005 for "Sink Performa V2 Single Bar."

Ziemann, Brigitte, U.S. Appl. No. 29/242,611, filed Nov. 10, 2005 for "Sink Performa K4 1.5."

Ziemann, Brigitte, U.S. Appl. No. 29/242,627, filed Nov. 10, 2005 for "Sink Performa K4 1.75."

Ziemann, Brigitte, U.S. Appl. No. 29/242,600, filed Nov. 10, 2005, for "Sink Performa V2 33 1.75 Left."

Schneider, Wolfgang et al., U.S. Appl. No. 29/256,748, filed Mar. 24, 2006 for "Sink."

Ziemann, Brigitte, U.S. Appl. No. 29/242,626, filed Nov. 10, 2005 for "Sink Performa K3 30 Single Bar."

Schneider, Wolfgang, U.S. Appl. No. 29/240,298, filed Oct. 11, 2005, for "Sink."

Ziemann, Brigitte, U.S. Appl. No. 29/242,610, filed Nov. 10, 2005 for "Sink Performa V2 Double."

Von Mertz, Gert Spruner et al., U.S. Appl. No. 11/321,683, filed Dec. 28, 2005 for "A Movement Mechanism for Moving a Closure Element for the Purposes of Sealing a Waste Outlet Opening."

Schneider, Wolfgang et al., U.S. Appl. No. 11/403,315, filed Apr. 13, 2006 for "Sink."

Ziemann, Brigitte, U.S. Appl. No. 29/242,523, filed Nov. 10, 2005 for "Sink Performa K3 30 Double."

Von Mertz, Gert Spruner, U.S. Appl. No. 11/057,961, filed Aug. 13, 2003, for "Installation Elements and Methods for Fastening an Installation Element to a Work Surface."

Schneider, Wolfgang et al., U.S. Appl. No. 10/872,855, filed Jun. 21, 2004, for "Packaging for a Sink."

* cited by examiner

Fig. 1

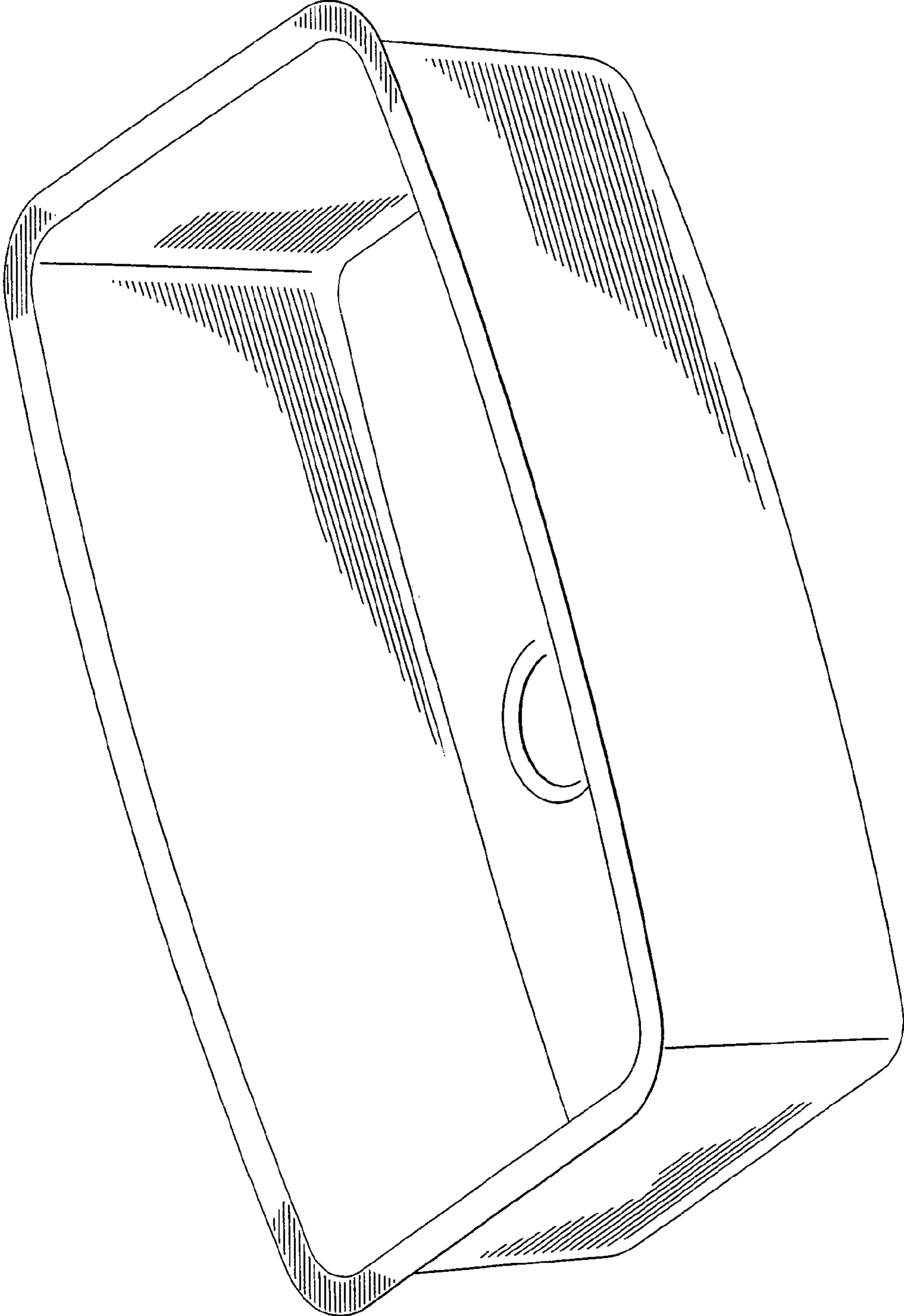

Fig. 2

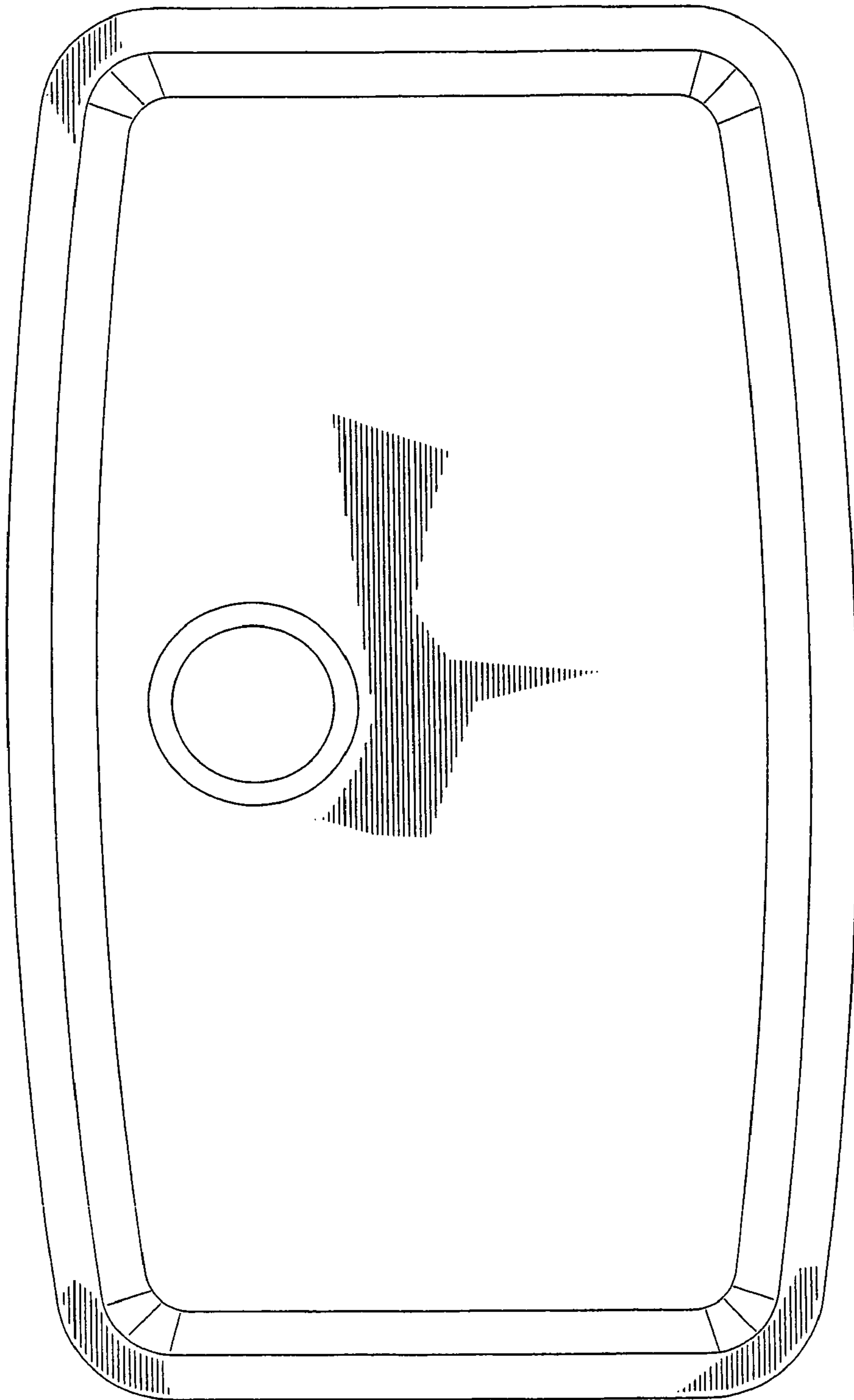

Fig. 3

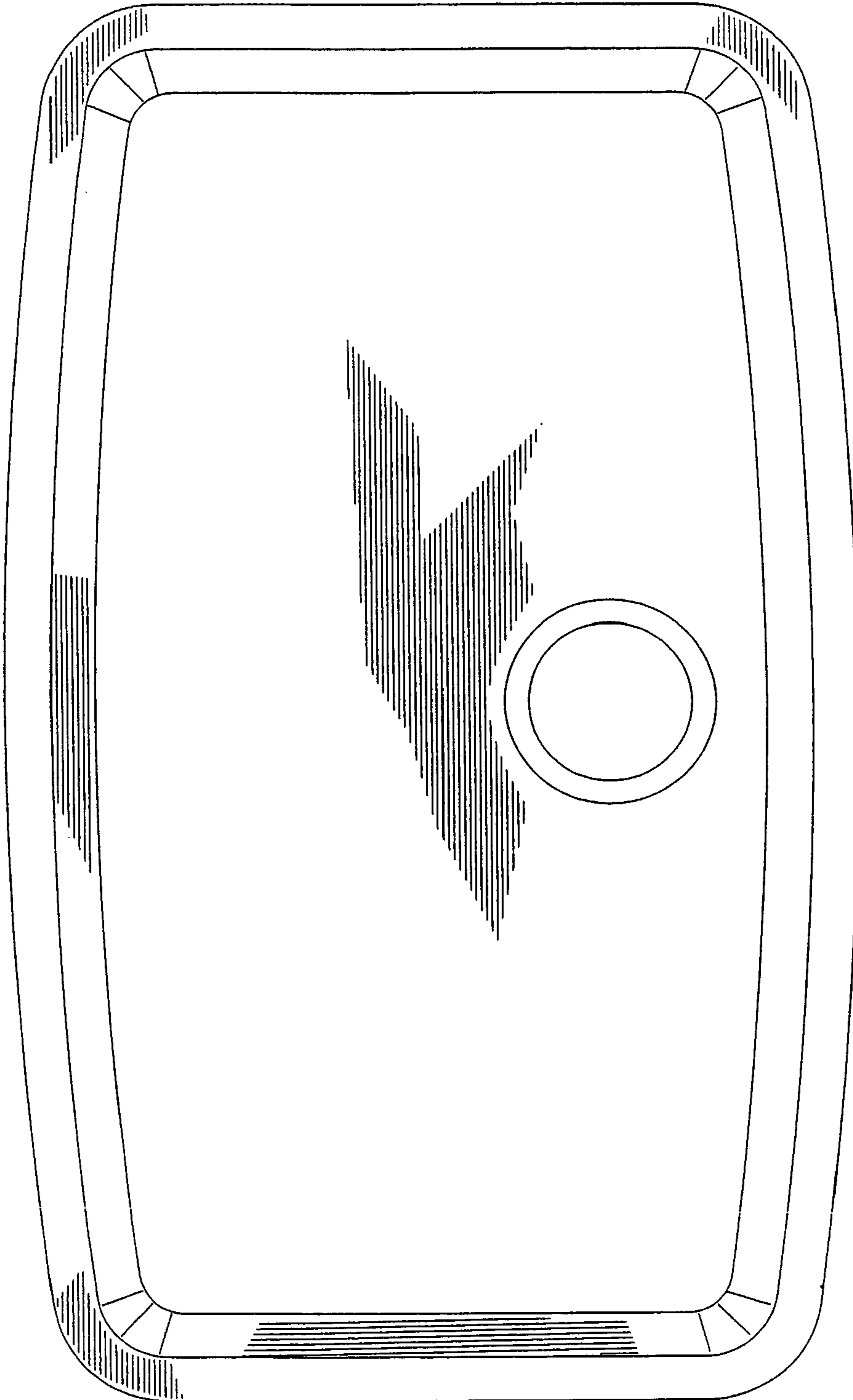

Fig. 4

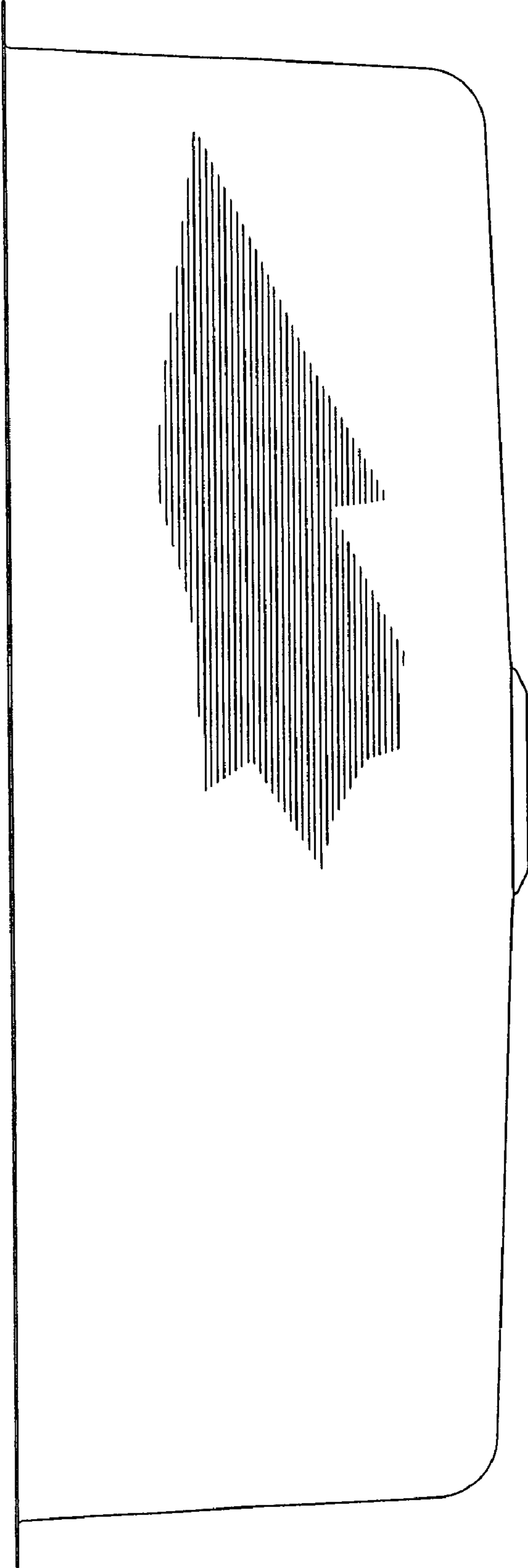

Fig. 5

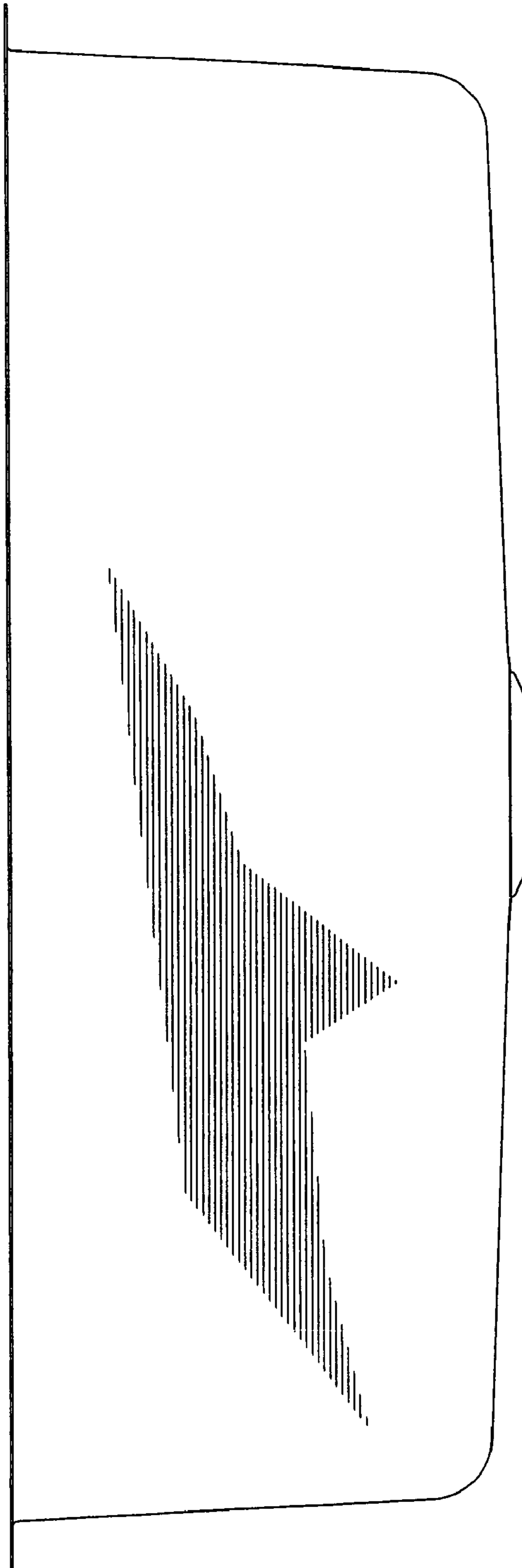

Fig. 6

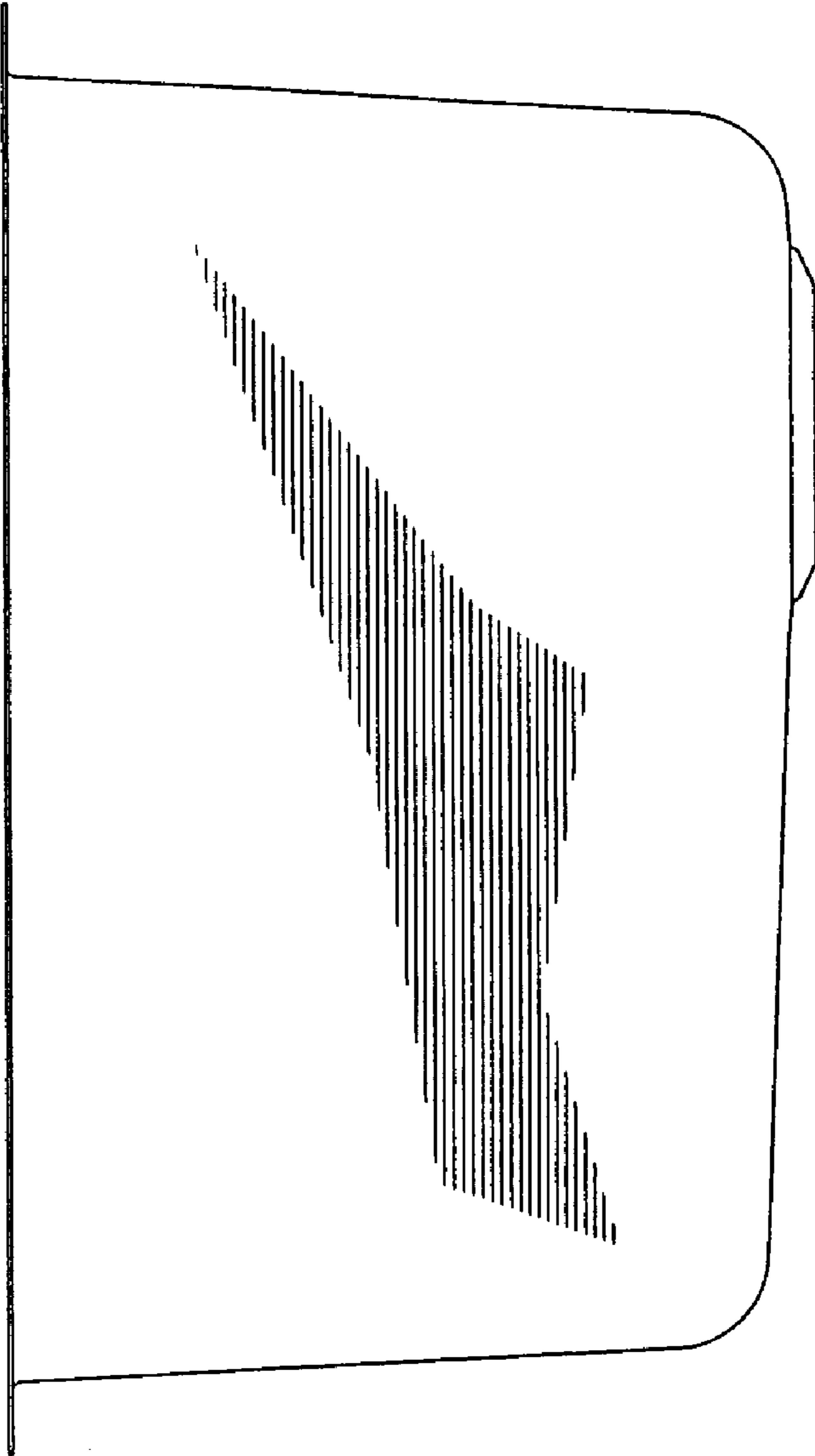

Fig. 7

