

US00D547680S

(12) **United States Design Patent**
King

(10) **Patent No.:** **US D547,680 S**

(45) **Date of Patent:** **** Jul. 31, 2007**

(54) **HINGE TEMPLATE**

(75) Inventor: **Joseph C. King**, Jackson, TN (US)

(73) Assignee: **Black & Decker Inc.**, Newark, DE (US)

(**) Term: **14 Years**

(21) Appl. No.: **29/265,446**

(22) Filed: **Aug. 31, 2006**

(51) **LOC (8) Cl.** **10-04**

(52) **U.S. Cl.** **D10/64**

(58) **Field of Classification Search** D10/64;
33/197

See application file for complete search history.

(56) **References Cited**

U.S. PATENT DOCUMENTS

5,029,394	A *	7/1991	Carey	33/197
5,042,543	A *	8/1991	Carey	33/197
D395,246	S *	6/1998	Carey	D10/64

D415,046 S * 10/1999 Carey D10/64
2006/0272166 A1 * 12/2006 Adkins et al. 33/197

* cited by examiner

Primary Examiner—Antoine D. Davis

(74) *Attorney, Agent, or Firm*—Scott B. Markow

(57) **CLAIM**

The ornamental design for a hinge template, as shown and described.

DESCRIPTION

FIG. 1 is a top/left perspective view of the hinge template.

FIG. 2 is a top view thereof.

FIG. 3 is a front elevational view thereof.

FIG. 4 is a left elevational view thereof.

FIG. 5 is a bottom view thereof.

FIG. 6 is a right elevational view thereof; and,

FIG. 7 is a rear elevational view thereof.

1 Claim, 7 Drawing Sheets

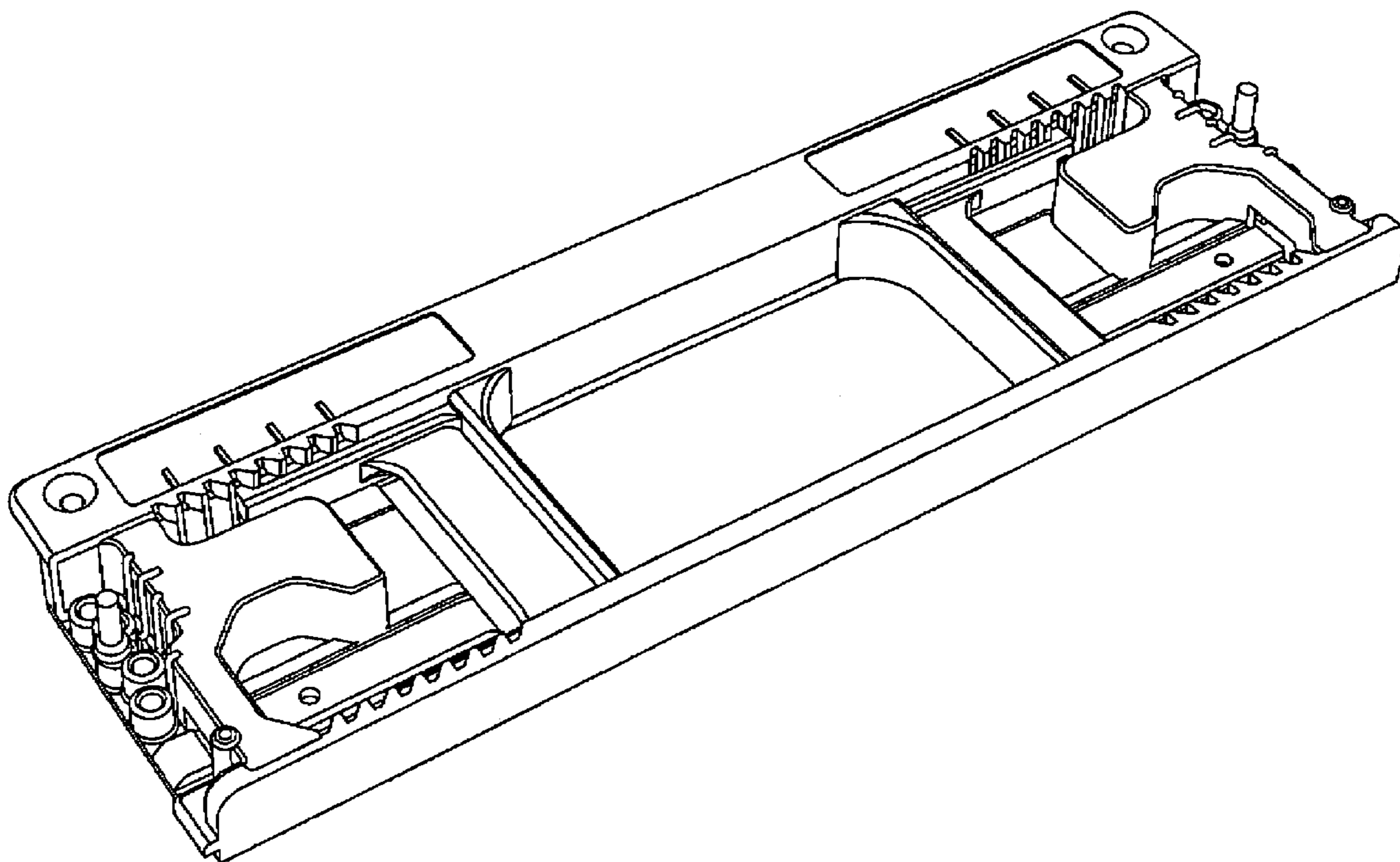

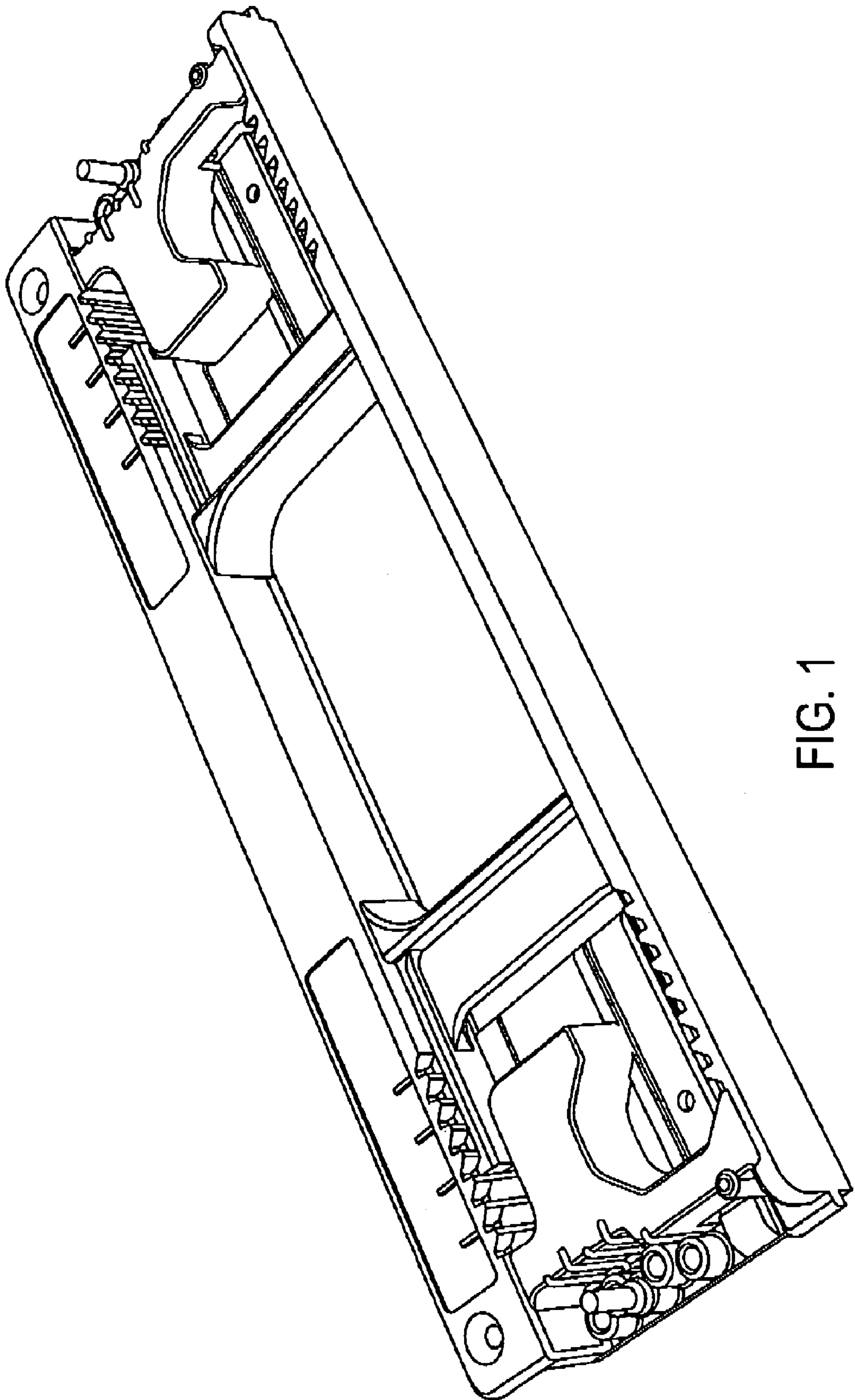

FIG. 1

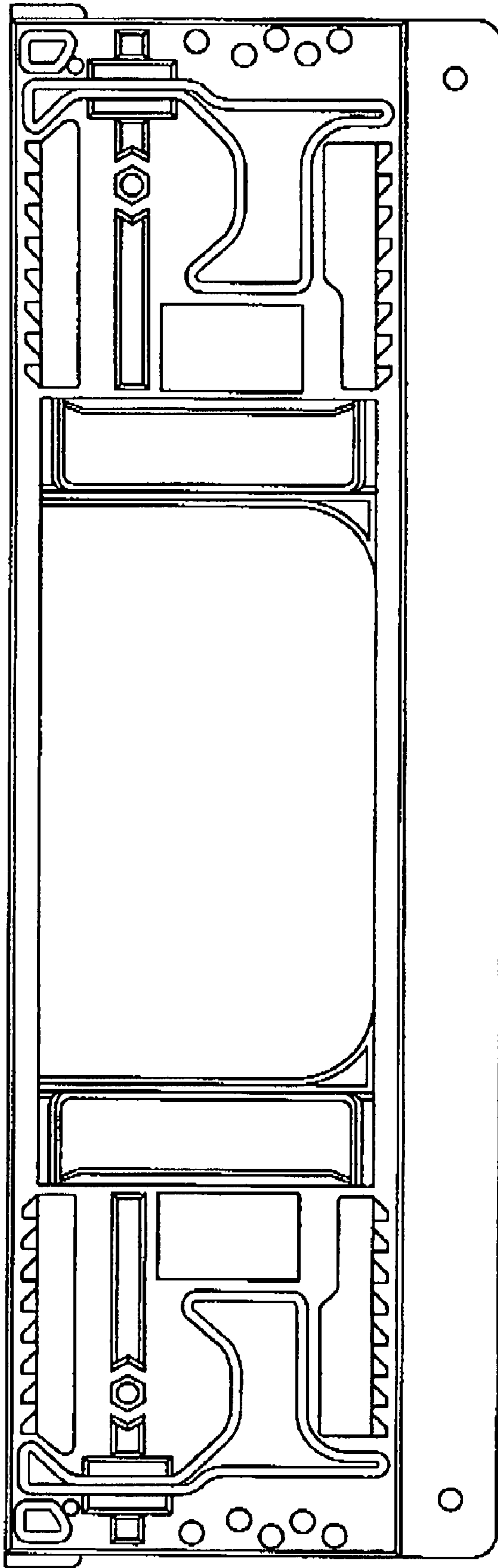

FIG. 2

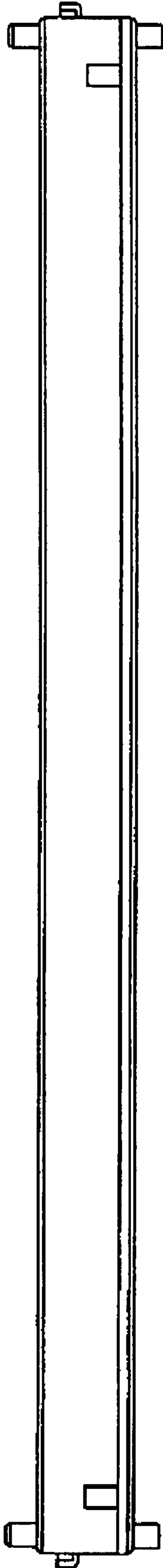

FIG. 3

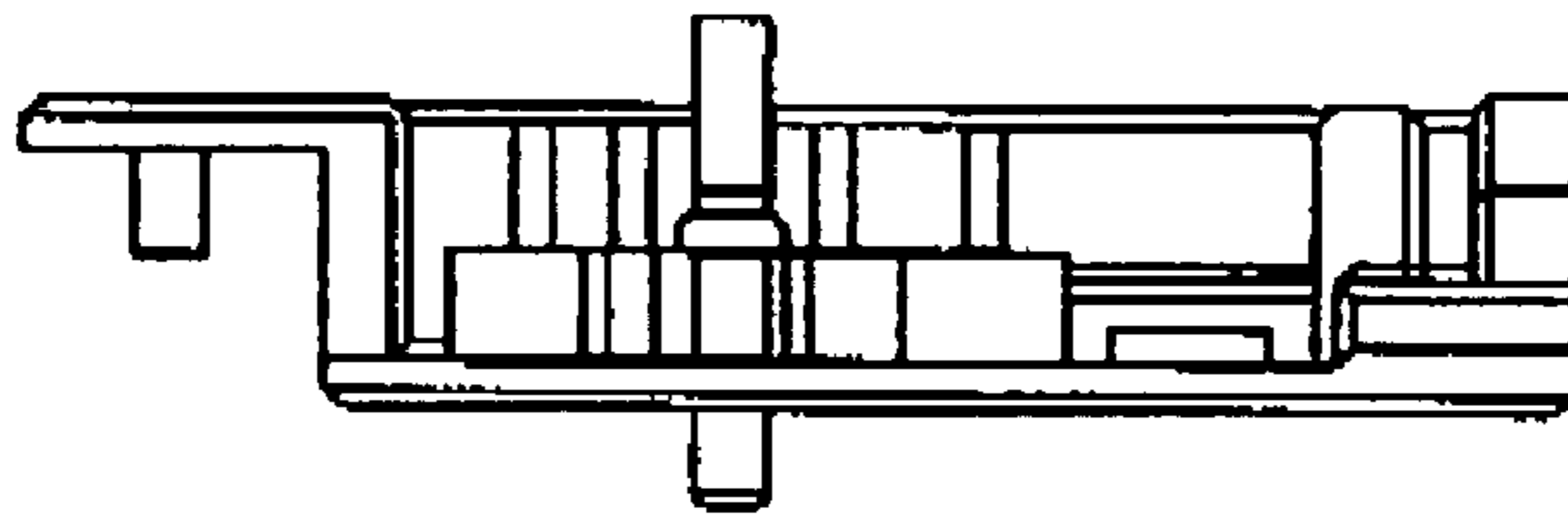

FIG. 4

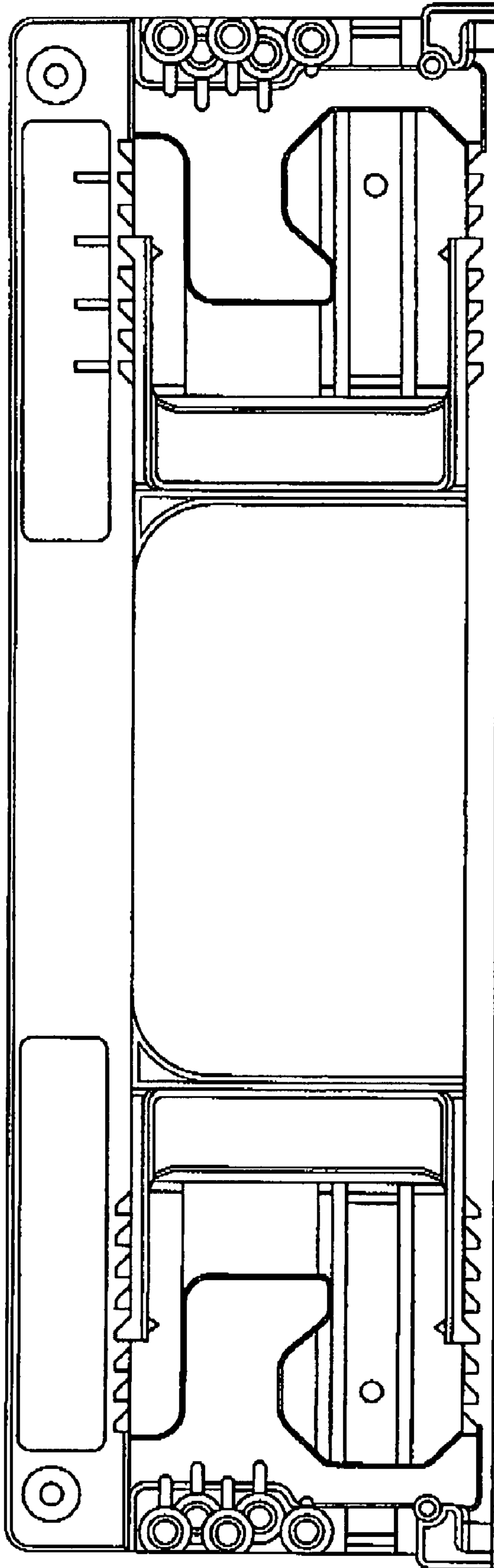

FIG. 5

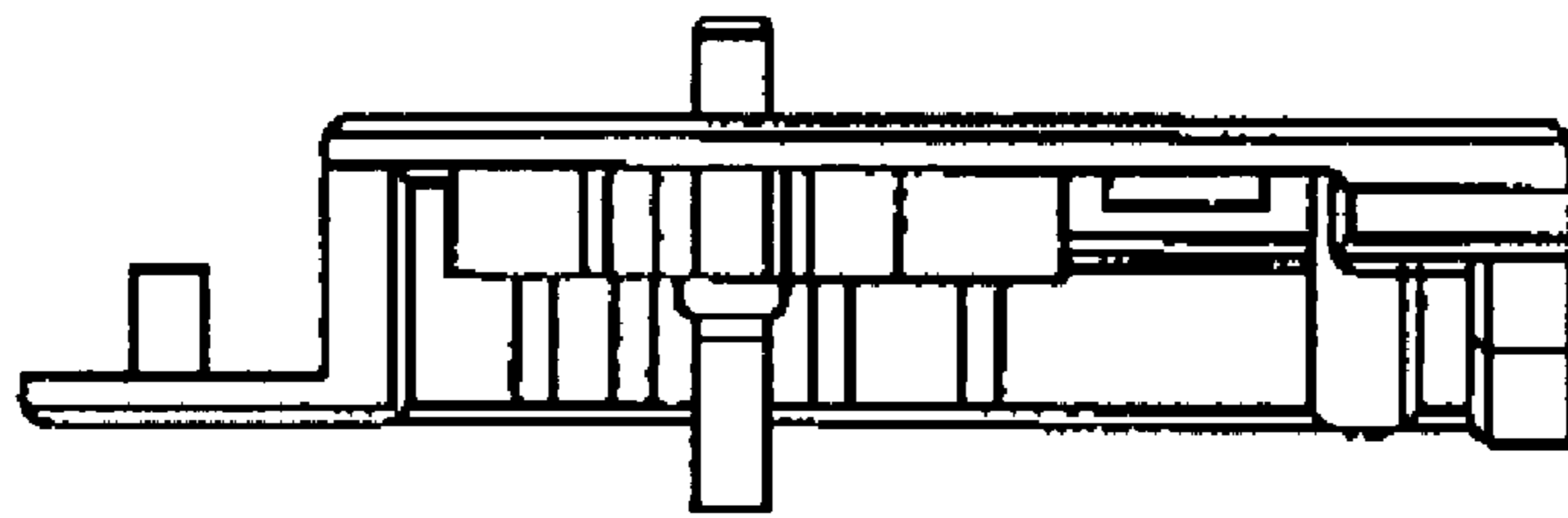

FIG. 6

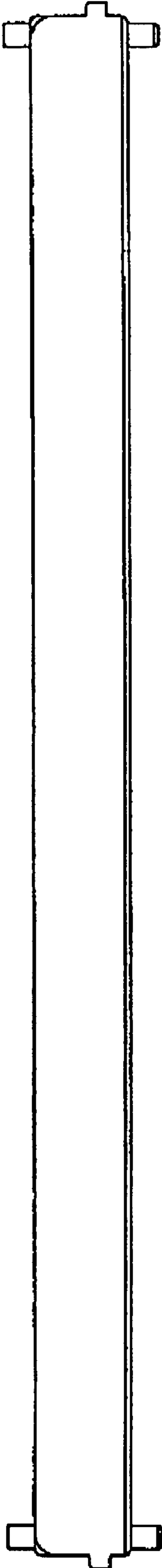

FIG. 7