



US00D547679S

(12) **United States Design Patent**
Juhng et al.

(10) **Patent No.:** **US D547,679 S**

(45) **Date of Patent:** **** Jul. 31, 2007**

(54) **WATCH**

(75) Inventors: **Leslie Juhng**, Philadelphia, PA (US);
Mathieu Turpault, Berwyn, PA (US)

(73) Assignee: **Nielsen-Kellerman**, Boothwyn, PA
(US)

(**) Term: **14 Years**

(21) Appl. No.: **29/258,623**

(22) Filed: **Apr. 24, 2006**

(51) **LOC (8) Cl.** **10-02**

(52) **U.S. Cl.** **D10/38**

(58) **Field of Classification Search** D10/30-39;
368/276-278, 281-283, 285, 21, 223, 239-242,
368/82-84, 29-30

See application file for complete search history.

(56) **References Cited**

U.S. PATENT DOCUMENTS

D370,858 S *	6/1996	Yamamoto	D10/38
D387,677 S *	12/1997	Hanagata	D10/30
5,812,500 A *	9/1998	Webb, Jr.	368/282
D399,757 S *	10/1998	Riley et al.	D10/30
D407,030 S *	3/1999	Toyoshima et al.	D10/39
D435,222 S *	12/2000	Yamamoto et al.	D10/31
D452,008 S *	12/2001	Komulainen	D24/167
D452,169 S *	12/2001	Syoubayashi	D10/30

D456,275 S *	4/2002	Blauner et al.	D10/30
D472,476 S *	4/2003	Ramos et al.	D10/30
D472,820 S *	4/2003	Ditullo et al.	D10/30
D505,084 S *	5/2005	Houlihan	D10/30
D506,683 S *	6/2005	Houlihan	D10/30
D512,922 S *	12/2005	Yan	D10/32
D516,440 S *	3/2006	Yan	D10/32

* cited by examiner

Primary Examiner—Lucy Lieberman

(74) *Attorney, Agent, or Firm*—Cozen O'Connor, P.C.

(57) **CLAIM**

The ornamental design for a “watch,” as shown and described.

DESCRIPTION

FIG. 1 is a perspective view of a watch showing our new design;

FIG. 2 is a top plan view thereof;

FIG. 3 is a bottom plan view thereof;

FIG. 4 is a left side elevational view thereof;

FIG. 5 is a right side elevational view thereof;

FIG. 6 is an end elevational view thereof; and,

FIG. 7 is the other end elevational view thereof.

1 Claim, 4 Drawing Sheets

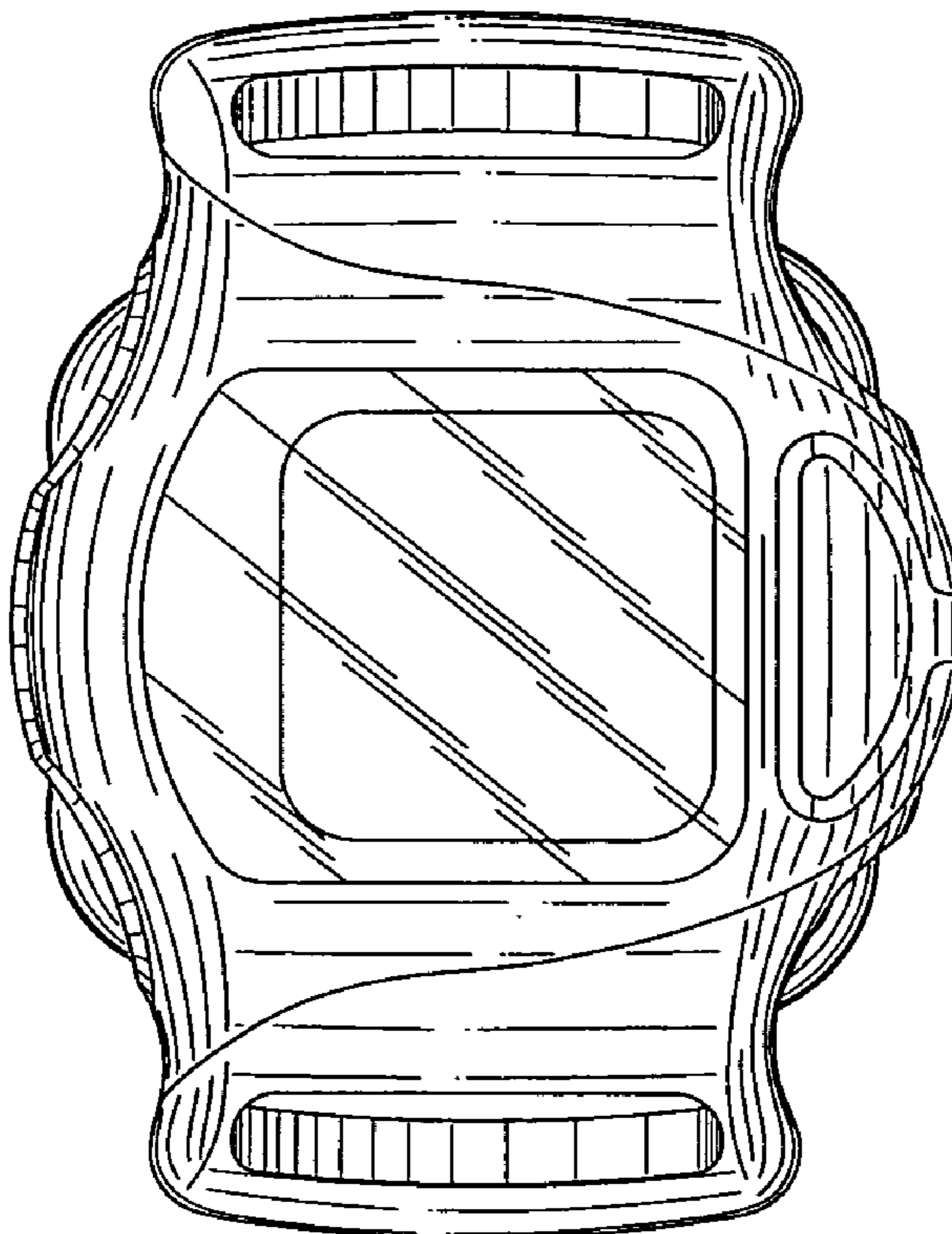

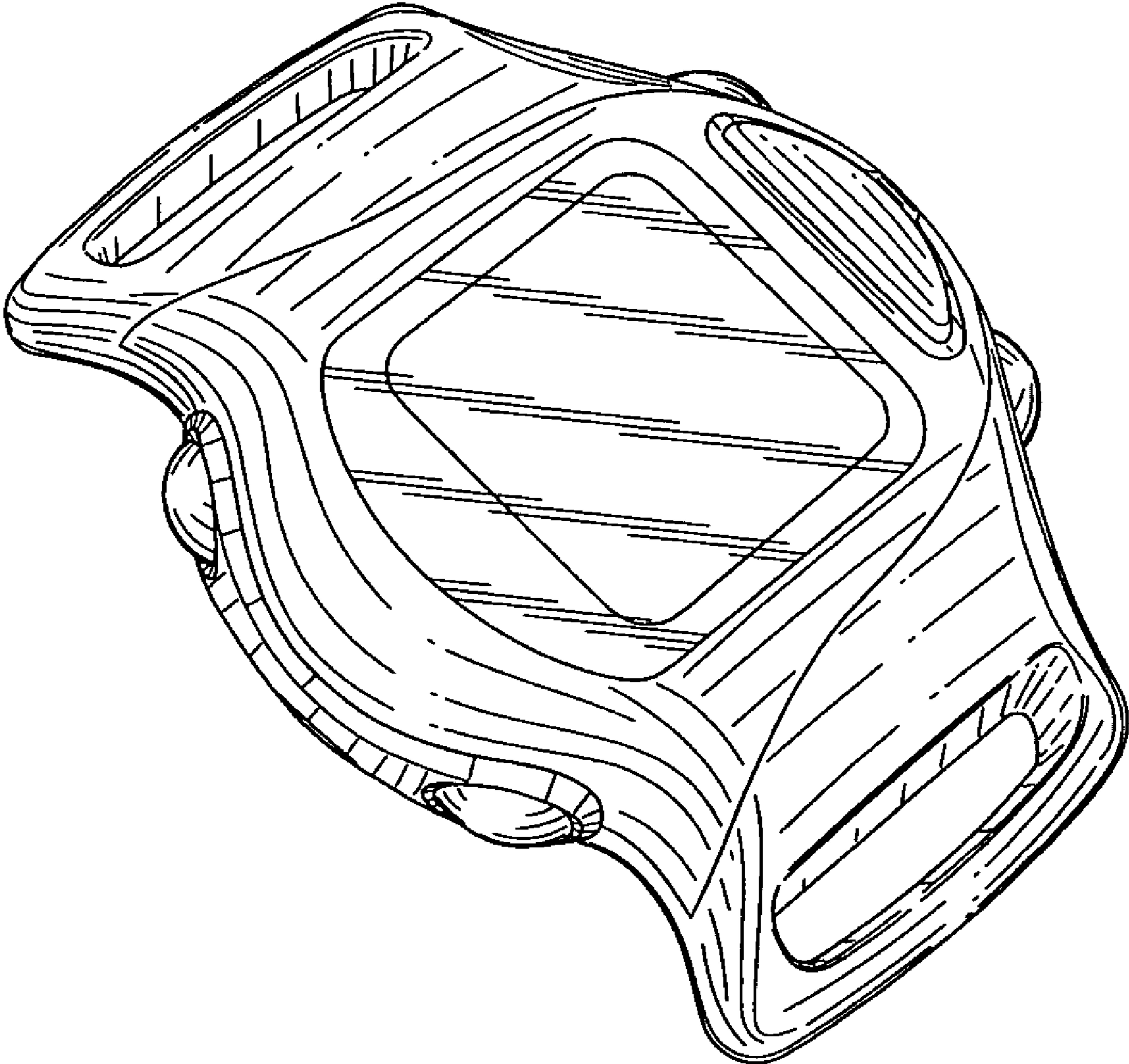

FIG. 1

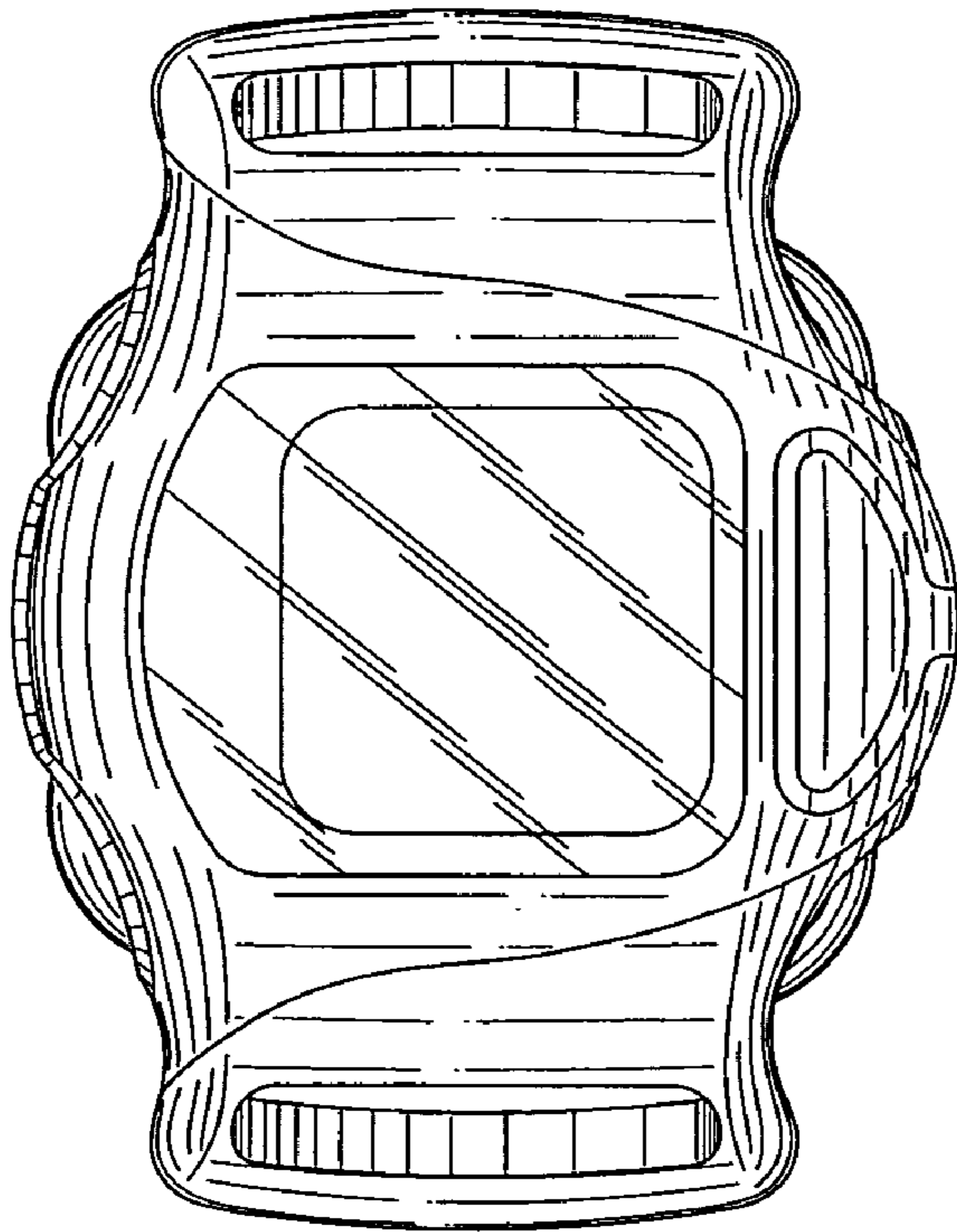

FIG. 2

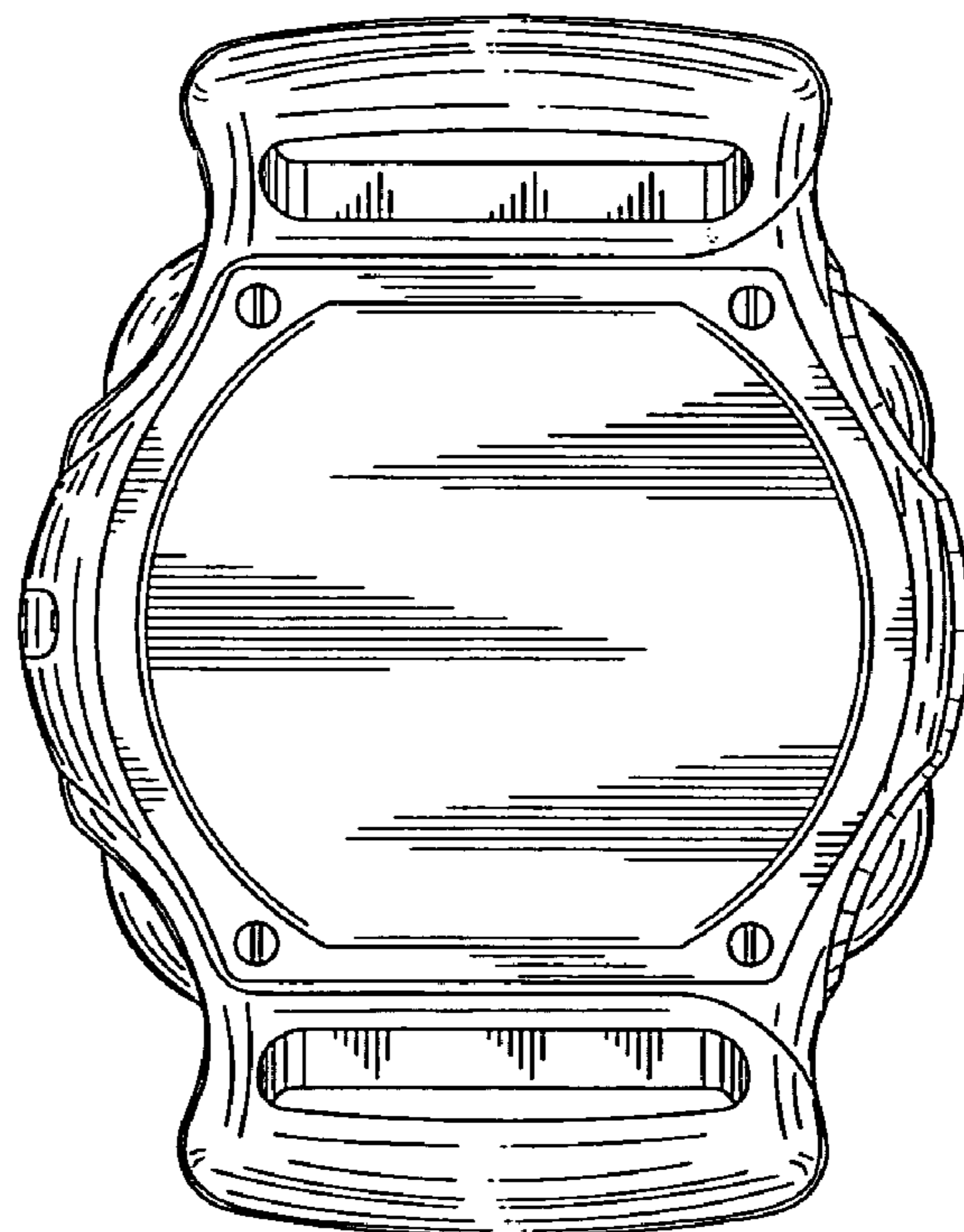

FIG. 3

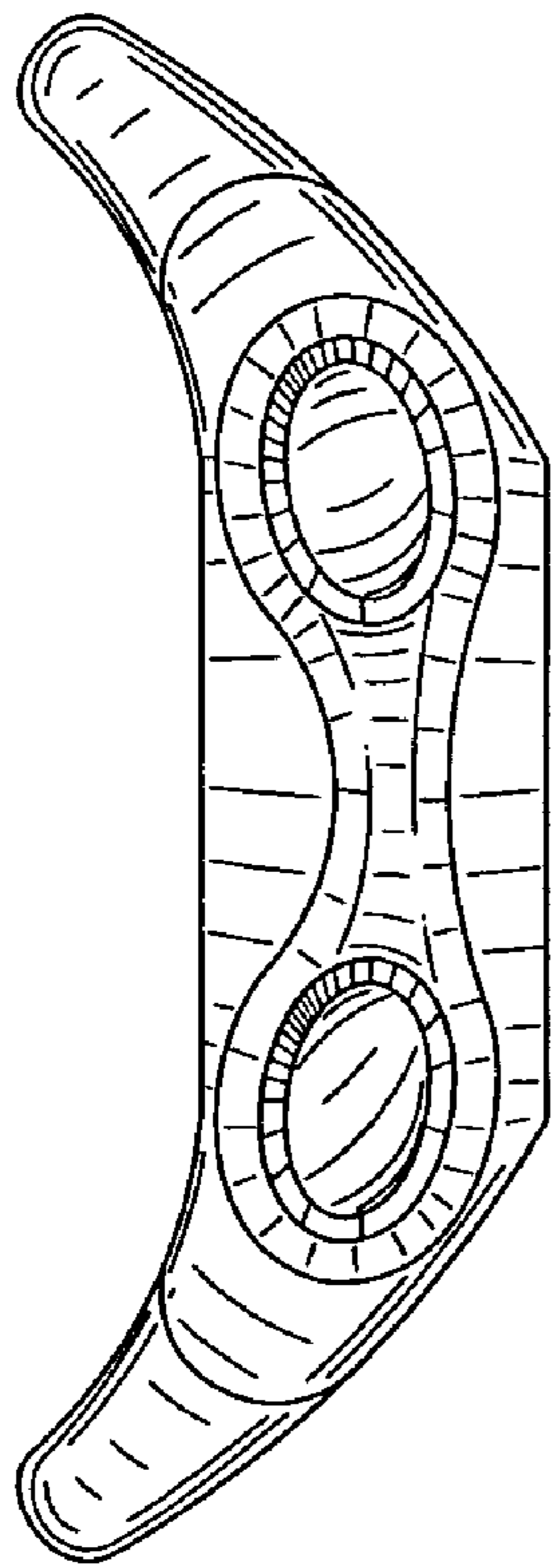

FIG. 4

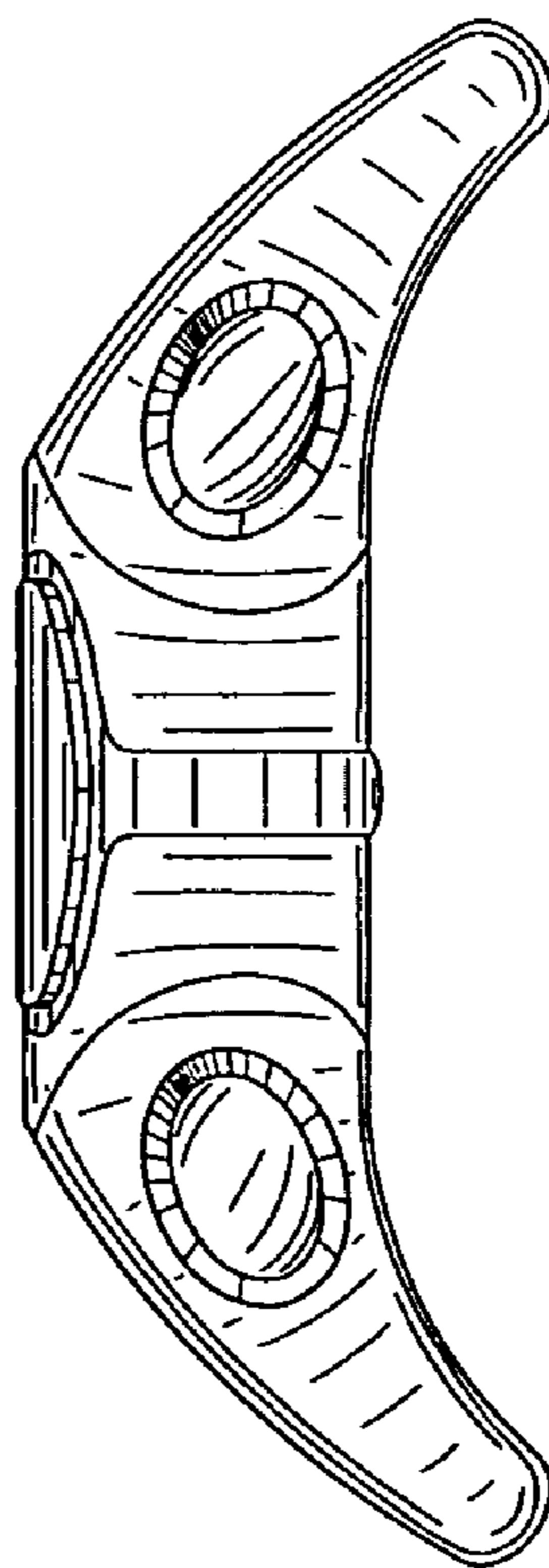

FIG. 5

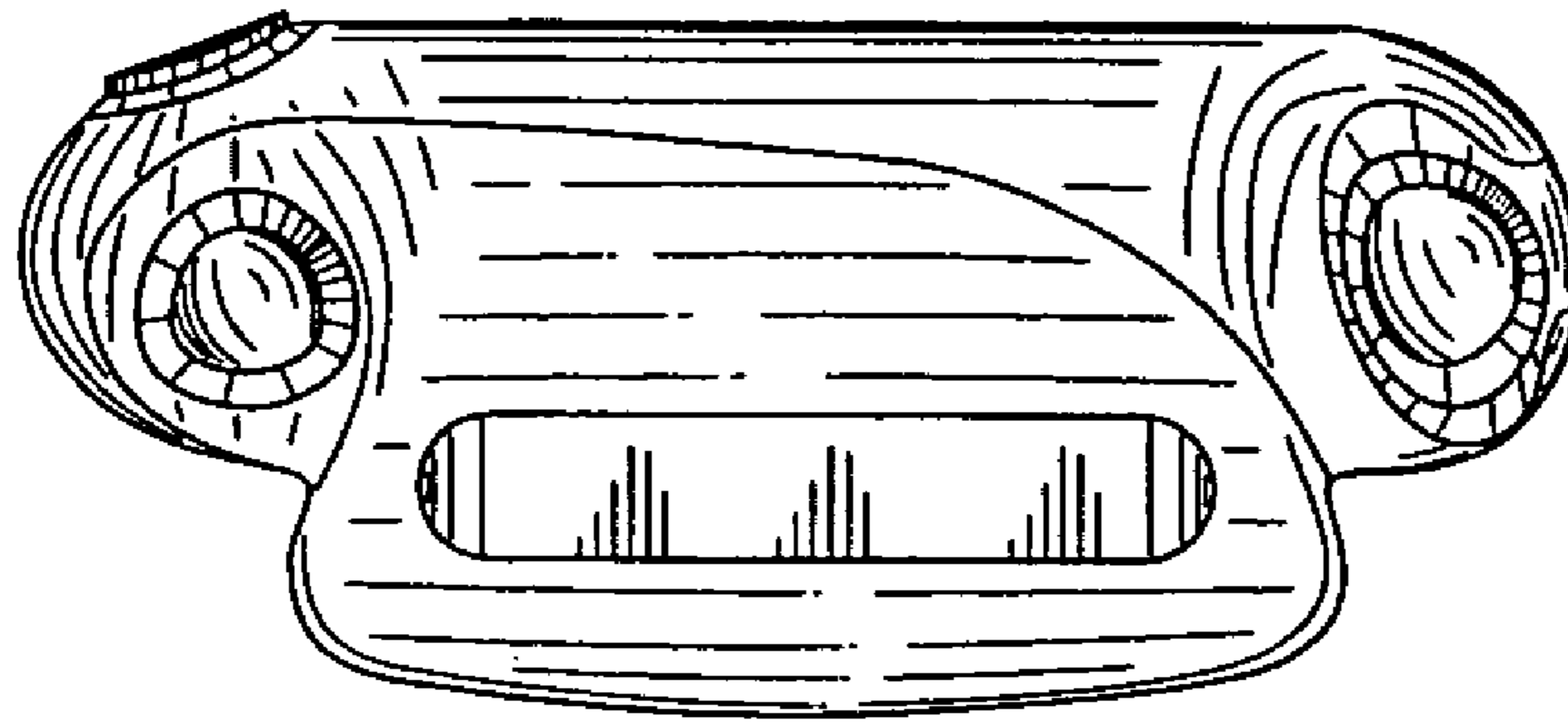

FIG. 6

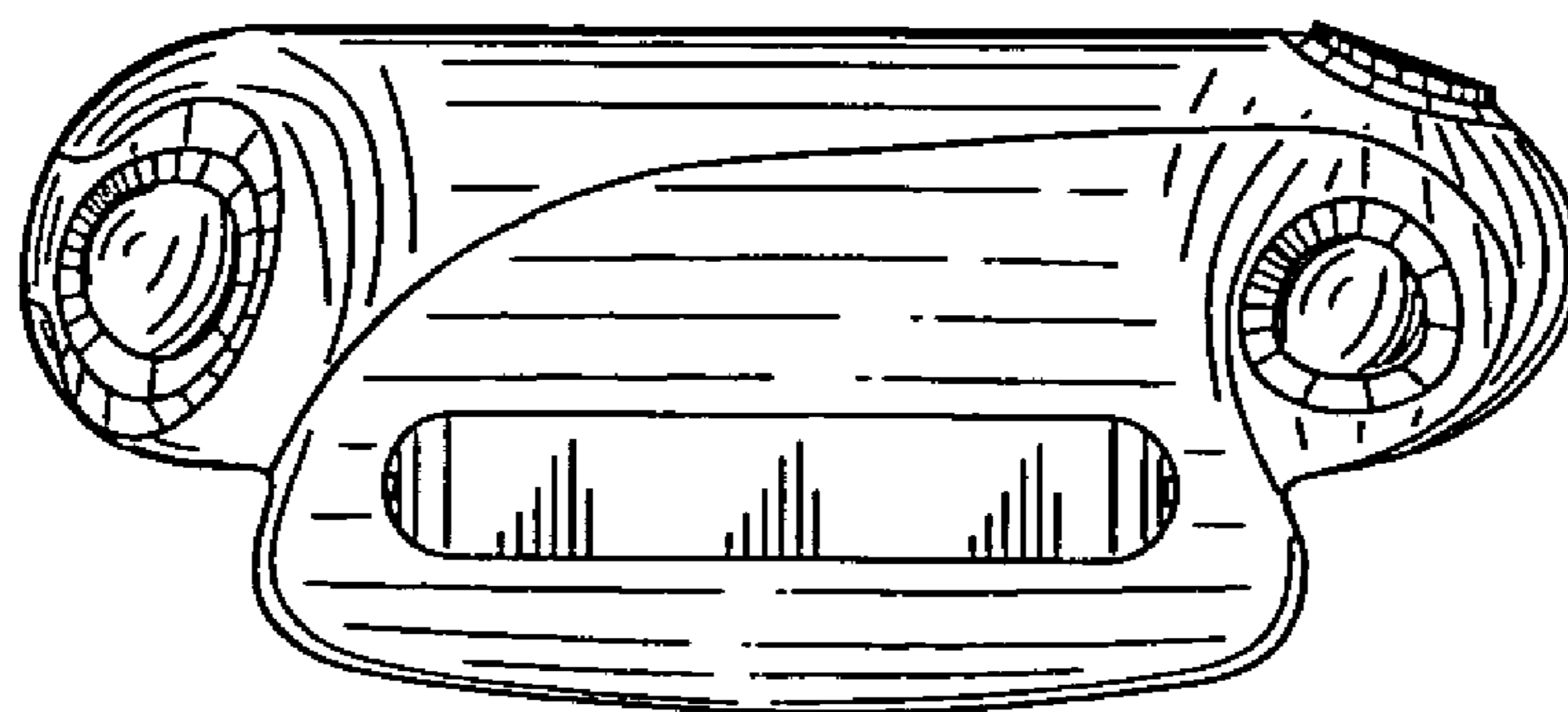

FIG. 7