

US00D547589S

(12) **United States Design Patent**
Albert

(10) **Patent No.:** **US D547,589 S**

(45) **Date of Patent:** **** Jul. 31, 2007**

(54) **COVER FOR VEHICLE SEAT**

2005/0242638 A1* 11/2005 Vitito 297/217.3

(75) Inventor: **Pascal Albert**, Bertrange (LU)

* cited by examiner

(73) Assignee: **Sevic System Luxembourg S.A.**,
Luxembourg (LU)

Primary Examiner—Louis S. Zarfaz

Assistant Examiner—Anhdao Doan

(**) Term: **14 Years**

(74) *Attorney, Agent, or Firm*—Polster, Lieder, Woodruff &
Lucchesi, L.C.

(21) Appl. No.: **29/222,396**

(57) **CLAIM**

(22) Filed: **Jan. 28, 2005**

The ornamental design for a cover for vehicle seat, as shown
and described.

(51) **LOC (8) Cl.** **06-13**

(52) **U.S. Cl.** **D6/611**

(58) **Field of Classification Search** D6/610,
D6/611; D12/401, 415, 416, 422, 426; 297/219.1,
297/219.11, 219.12, 220, 224, 225, 228.1,
297/228.13, 229, 217.3; D3/303

See application file for complete search history.

DESCRIPTION

FIG. 1 is a perspective view of a cover for vehicle seat
showing my new design;

FIG. 2 is a front view of the embodiment shown in FIG. 1;

FIG. 3 is a right side view of the embodiment shown in FIG.
1;

FIG. 4 is a left side view of the embodiment shown in FIG.
1;

FIG. 5 is a rear view of the embodiment shown in FIG. 1;

FIG. 6 is a top view of the embodiment shown in FIG. 1;
and,

FIG. 7 is a bottom view of the embodiment shown in FIG.
1.

The broken lines in the drawings are for illustrative purposes
only and form no part of the claimed design.

(56) **References Cited**

U.S. PATENT DOCUMENTS

D309,227 S *	7/1990	Popiolkowski	D6/610
D425,303 S *	5/2000	Klonowski	D3/303
6,406,334 B2 *	6/2002	Chu	297/217.3
D472,095 S *	3/2003	Smith et al.	D6/611
6,786,547 B1 *	9/2004	Chu	297/220
6,899,365 B2 *	5/2005	Lavelle et al.	297/217.4
7,040,697 B1 *	5/2006	Tuccinardi et al.	297/217.3
7,066,544 B2 *	6/2006	Tseng	297/391
2004/0007906 A1 *	1/2004	Park et al.	297/217.3
2005/0200697 A1 *	9/2005	Schedivy et al.	348/61
2005/0206206 A1 *	9/2005	Peng	297/217.3

1 Claim, 1 Drawing Sheet

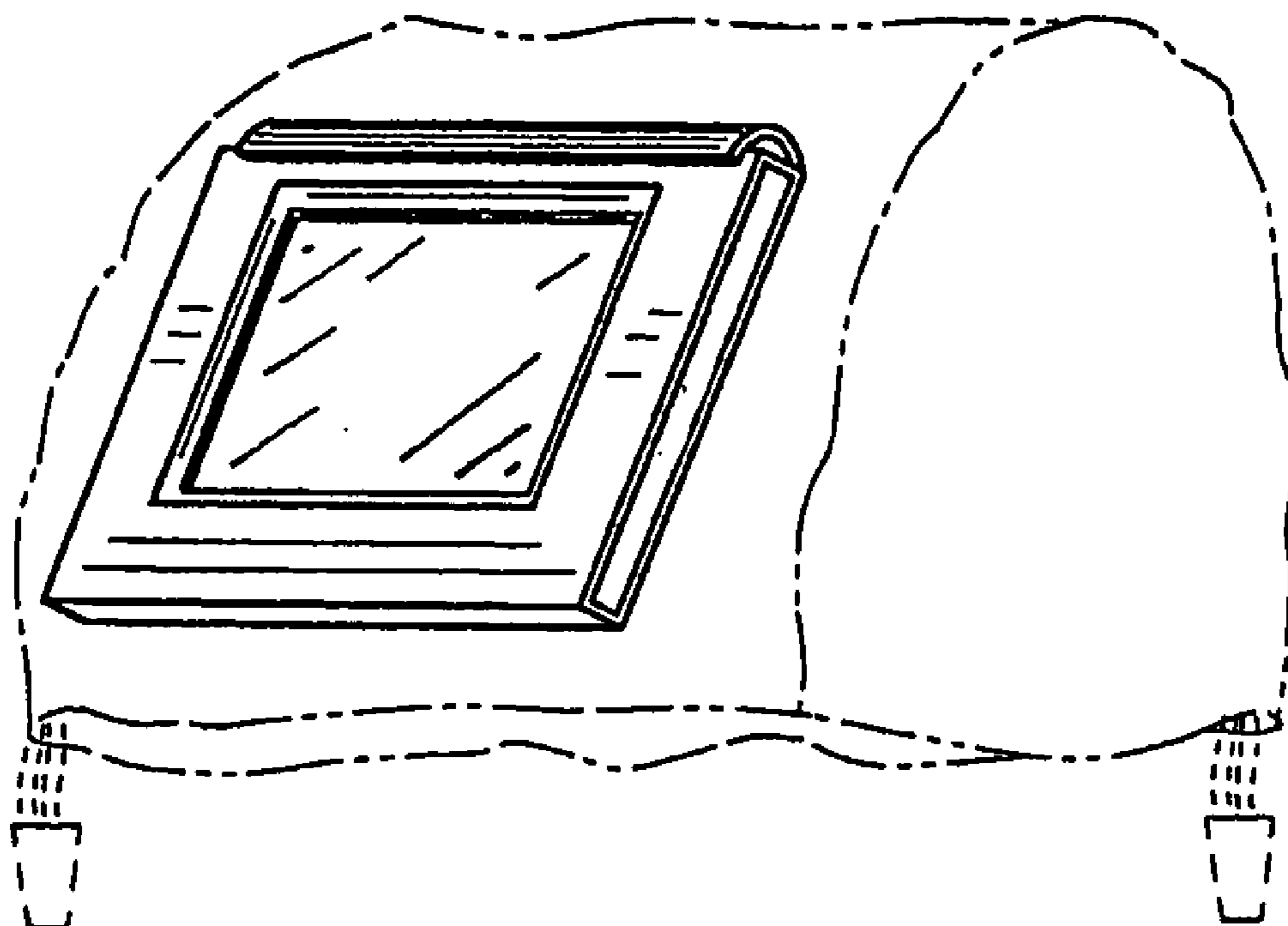

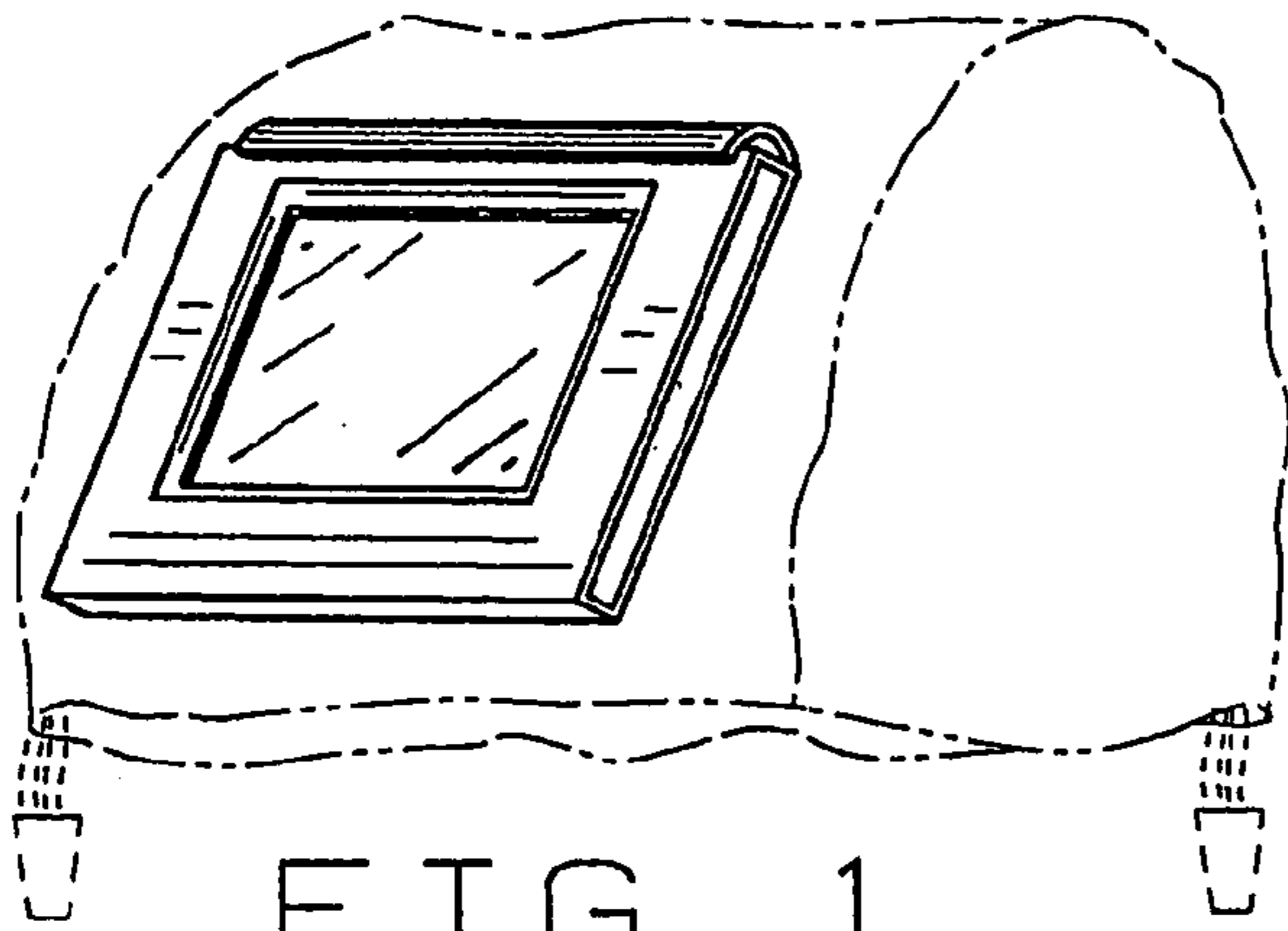

FIG. 1

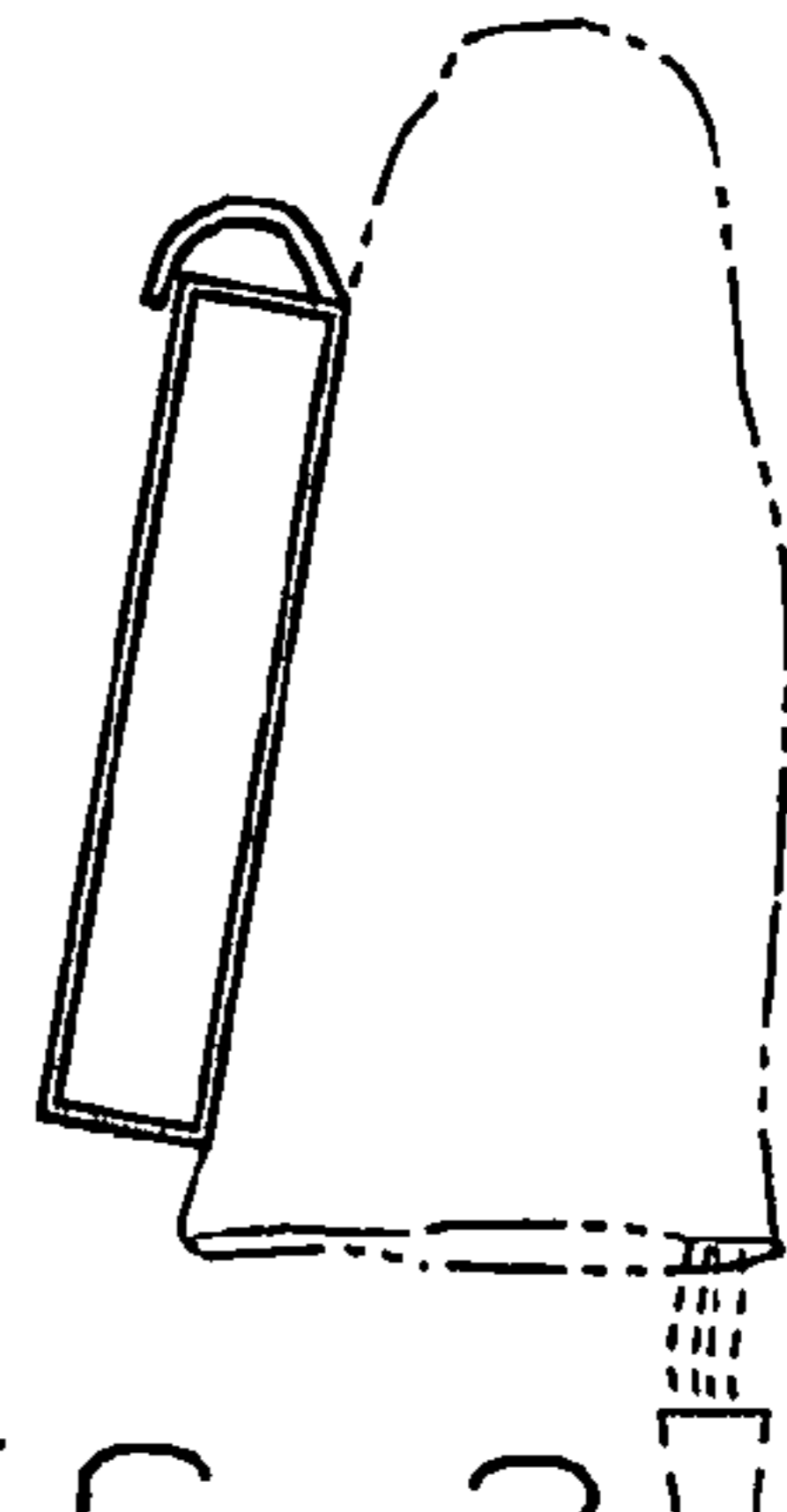

FIG. 2

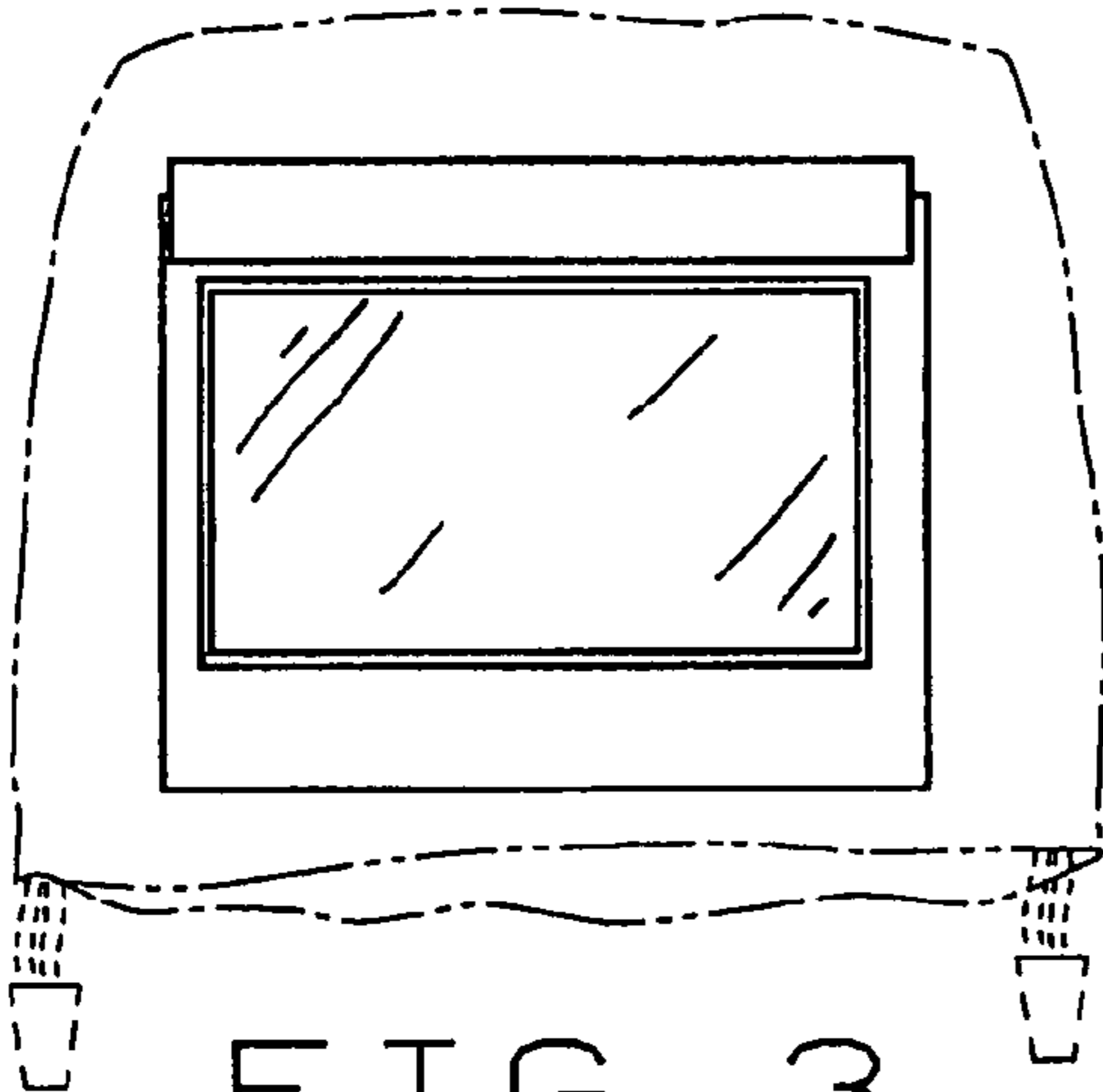

FIG. 3

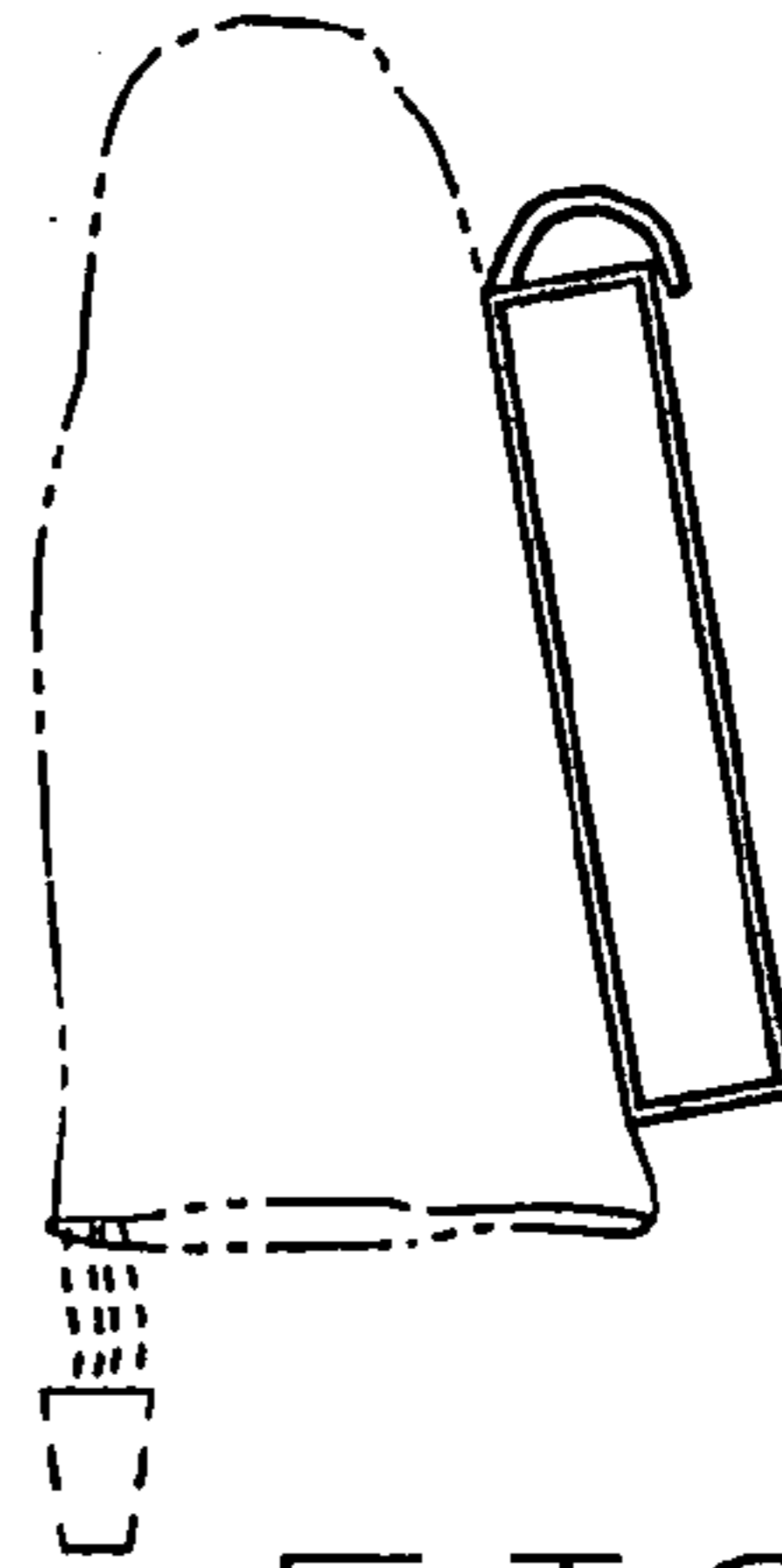

FIG. 4

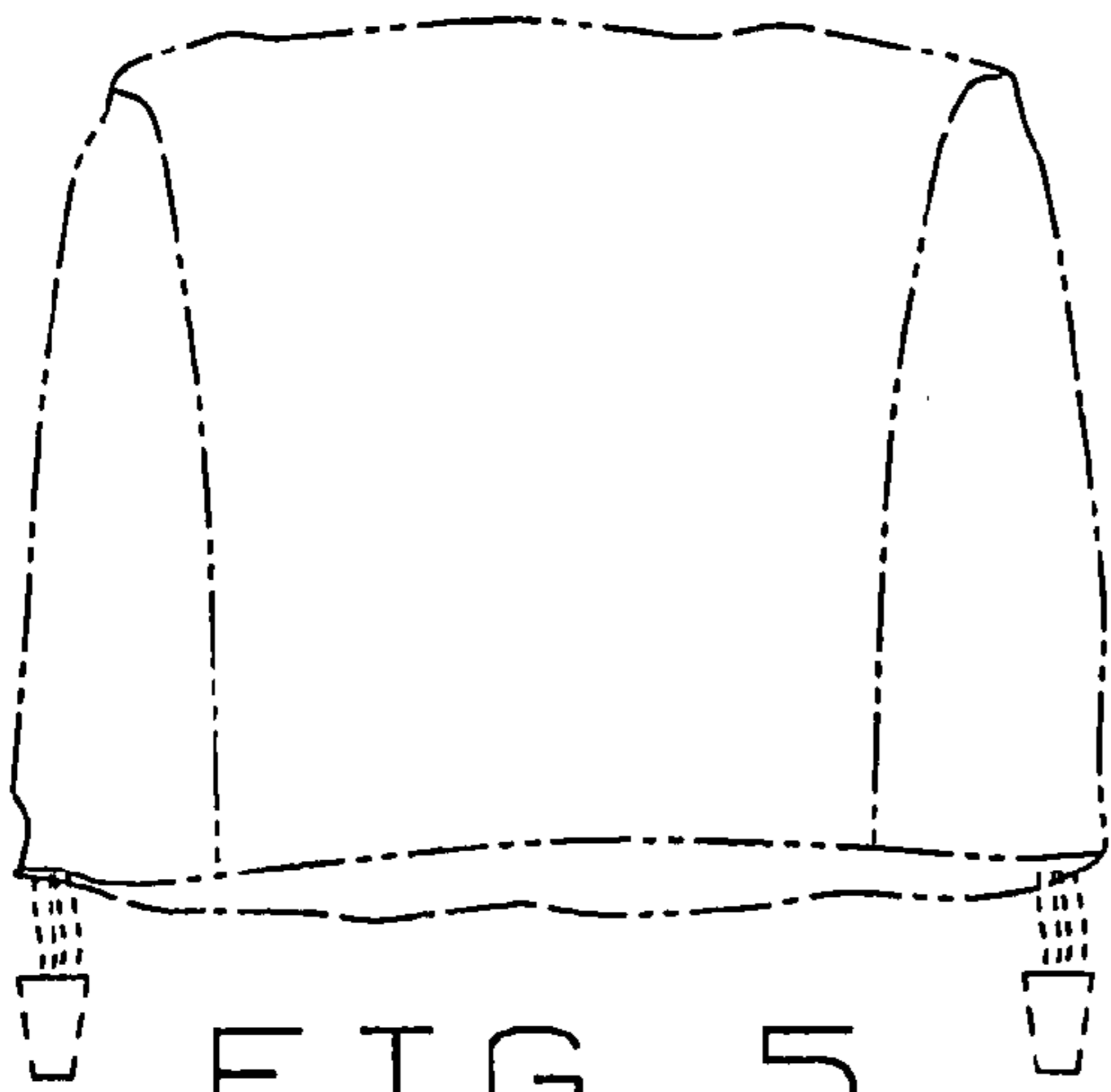

FIG. 5

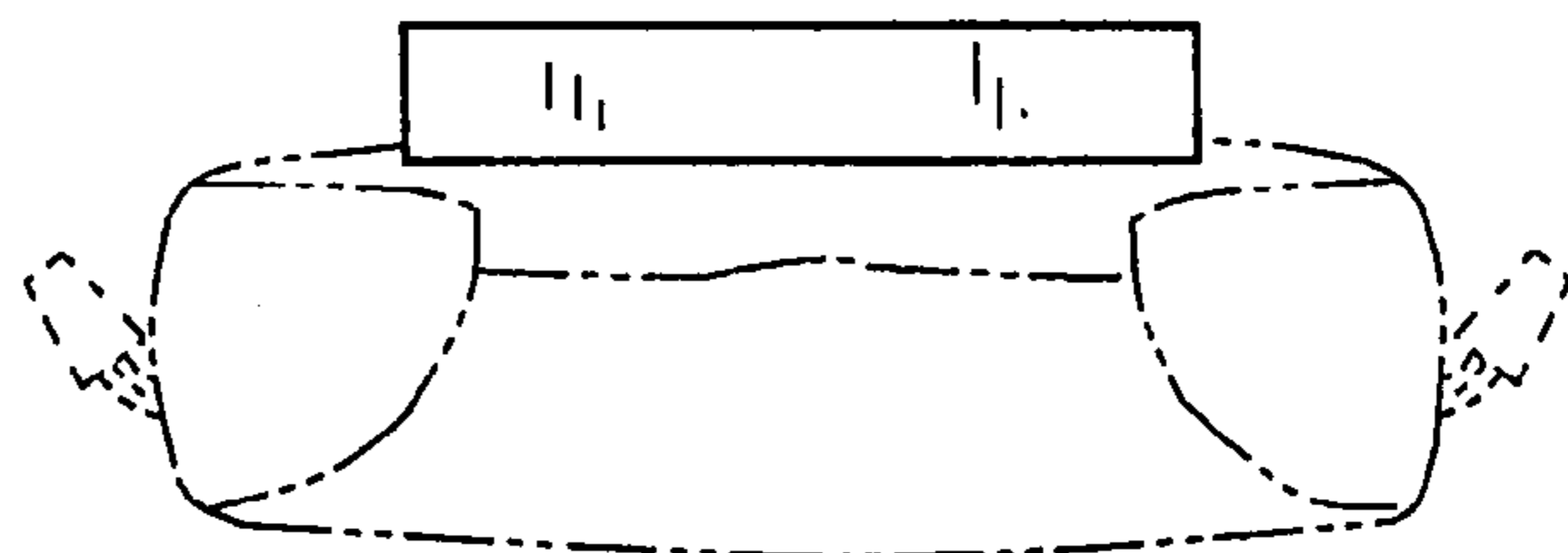

FIG. 6

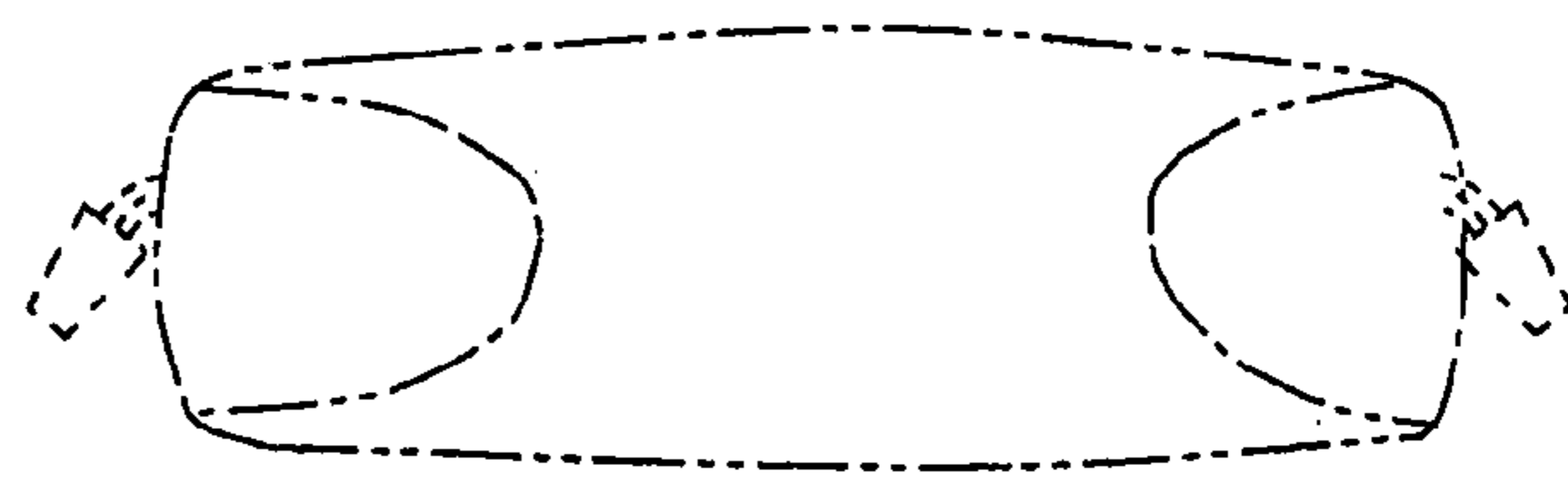

FIG. 7