

US00D547570S

(12) **United States Design Patent** (10) **Patent No.:** **US D547,570 S**  
**Belokin et al.** (45) **Date of Patent:** **\*\* Jul. 31, 2007**

(54) **DISPLAY TRAY**

(75) Inventors: **Paul Belokin**, Denton County, TX (US); **Martin P. Belokin**, Denton County, TX (US); **Norman P. Belokin**, Denton County, TX (US)

(73) Assignee: **Displays by Martin Paul, Inc.-Creative Center**, Denton, TX (US)

(\*\*) Term: **14 Years**

(21) Appl. No.: **29/235,822**

(22) Filed: **Aug. 8, 2005**

(51) **LOC (8) Cl.** ..... **06-04**

(52) **U.S. Cl.** ..... **D6/475**

(58) **Field of Classification Search** ..... D3/304;  
D6/408, 510, 574; 206/557; 211/85.4, 71.01,  
211/88.01, 90.01, 119.003, 183  
See application file for complete search history.

(56) **References Cited**

**U.S. PATENT DOCUMENTS**

D281,477 S \* 11/1985 Neff ..... D6/574  
D305,841 S \* 2/1990 MacQueen ..... D6/475  
D333,052 S \* 2/1993 Bumb ..... D6/476  
D351,957 S \* 11/1994 Bumb ..... D6/475  
D368,584 S \* 4/1996 Stommel, Jr. .... D3/313

D390,052 S \* 2/1998 Wolff ..... D6/510  
D495,490 S \* 9/2004 Garrett et al. .... D3/304  
D496,179 S \* 9/2004 Sjoberg ..... D6/408  
D530,921 S \* 10/2006 Snell ..... D3/304

\* cited by examiner

*Primary Examiner*—Cathron C. Brooks  
*Assistant Examiner*—Kelley A. Donnelly  
(74) *Attorney, Agent, or Firm*—Jack A. Kanz

(57) **CLAIM**

The ornamental design for display tray, as shown and described.

**DESCRIPTION**

FIG. 1 is a rear perspective view of a display tray showing our new design;

FIG. 2 is a front elevational view thereof;

FIG. 3 is a side elevational view of the right-hand side thereof, the left-hand side view being a mirror image of FIG. 3; and

FIG. 4 is a rear elevational view thereof;

FIG. 5 is a top plan view thereof; and,

FIG. 6 is a bottom plan view of our new design for a display tray.

**1 Claim, 4 Drawing Sheets**

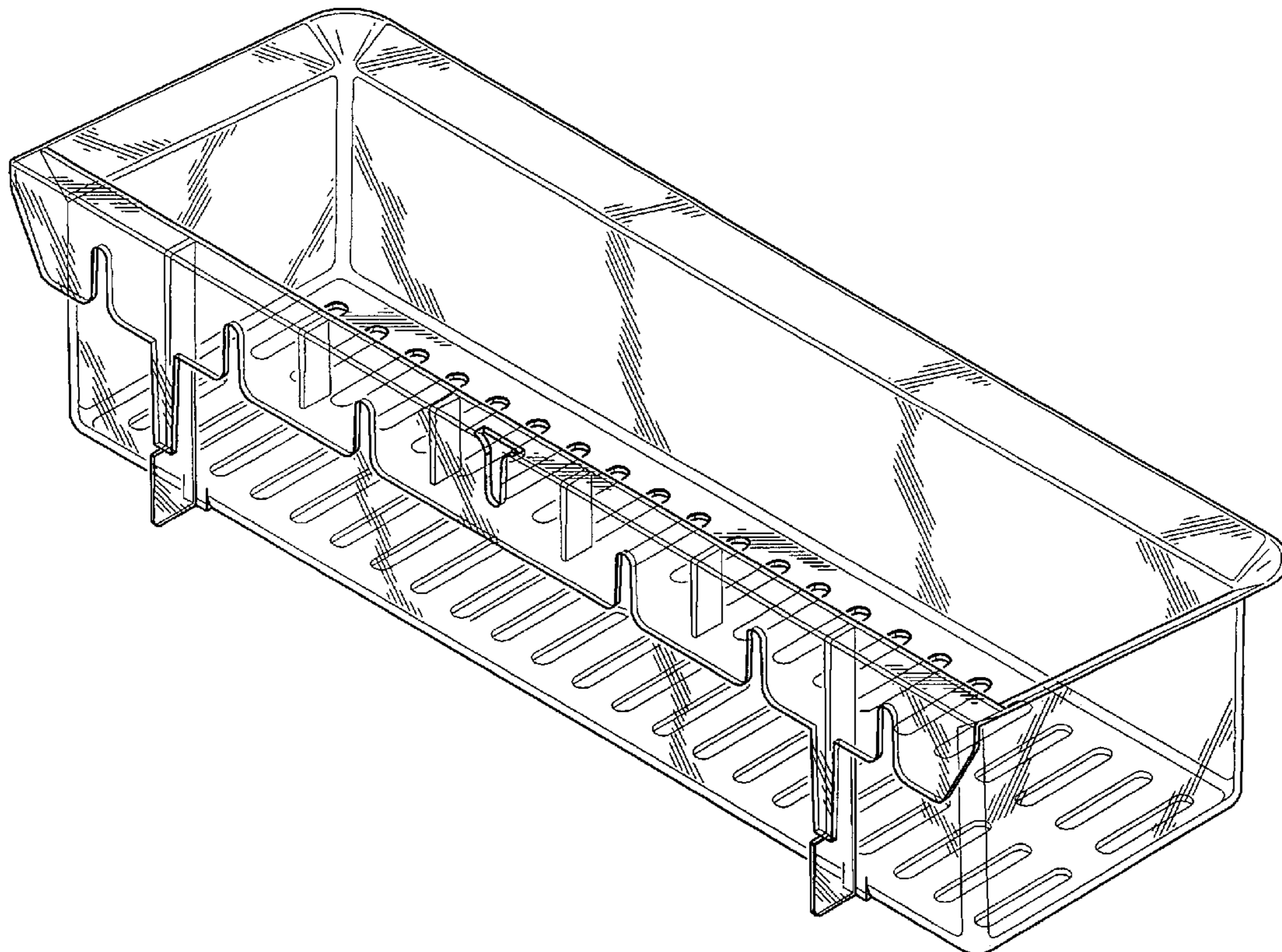

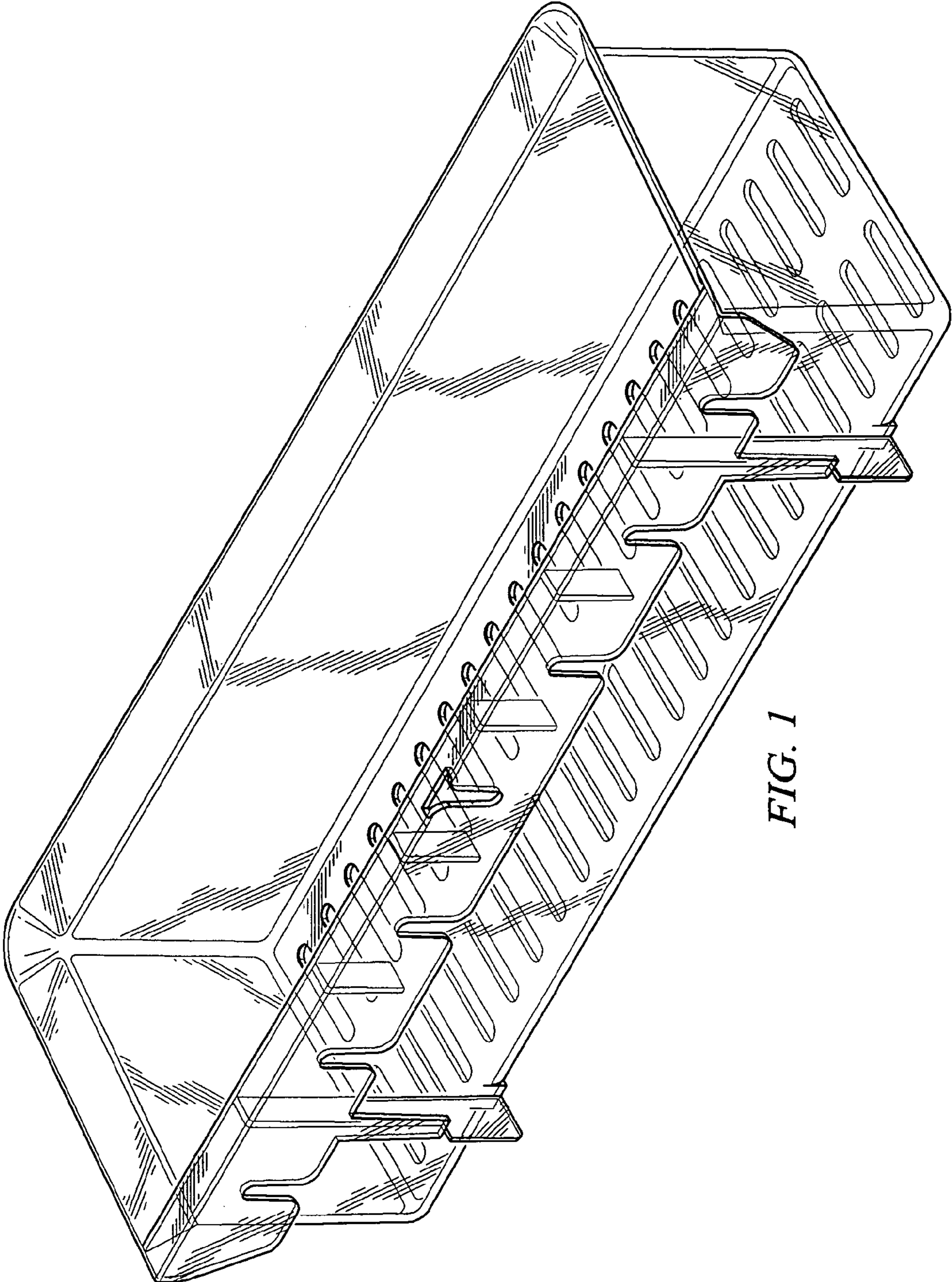

FIG. 1

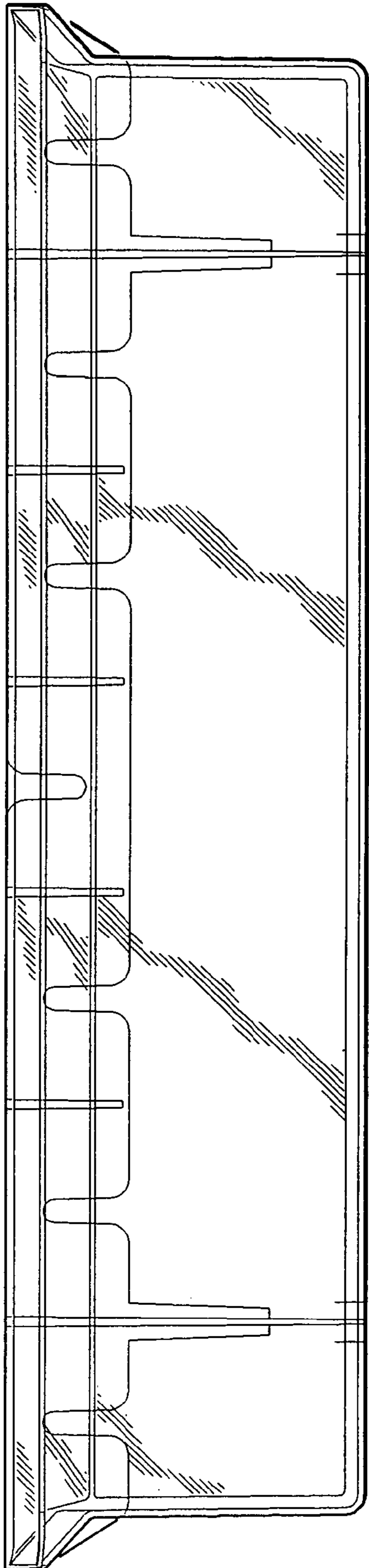

FIG. 2

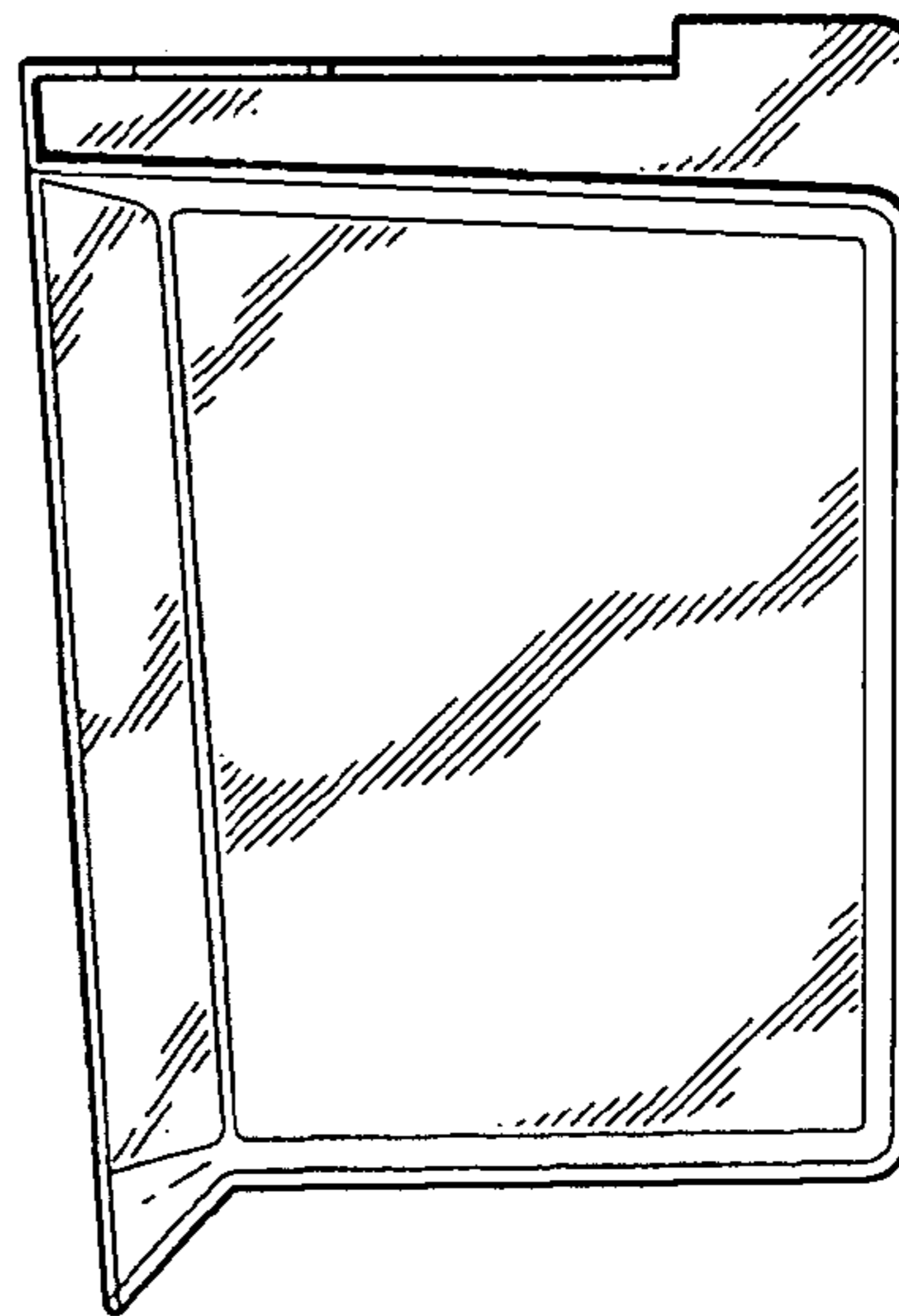

FIG. 3

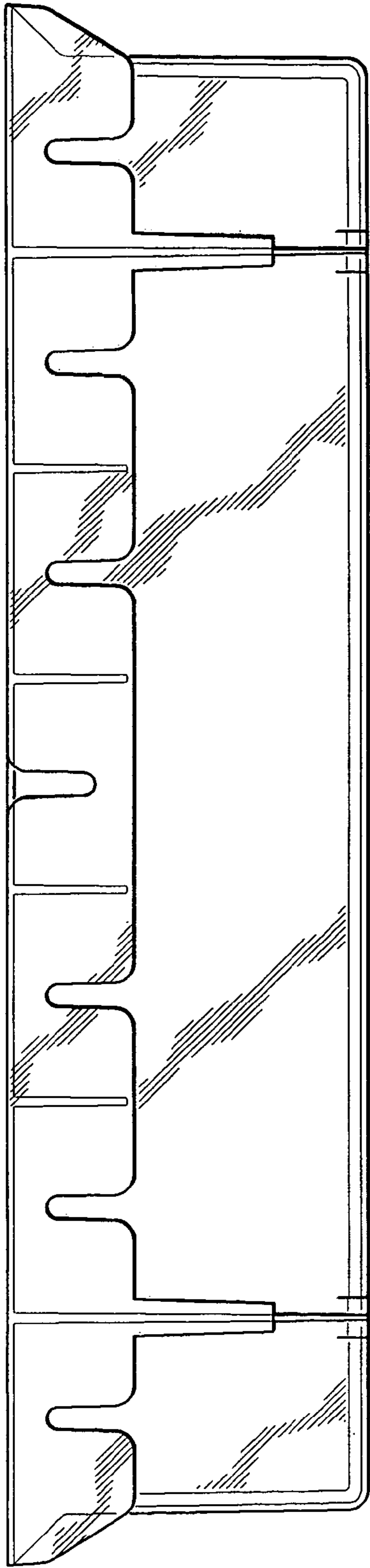

FIG. 4

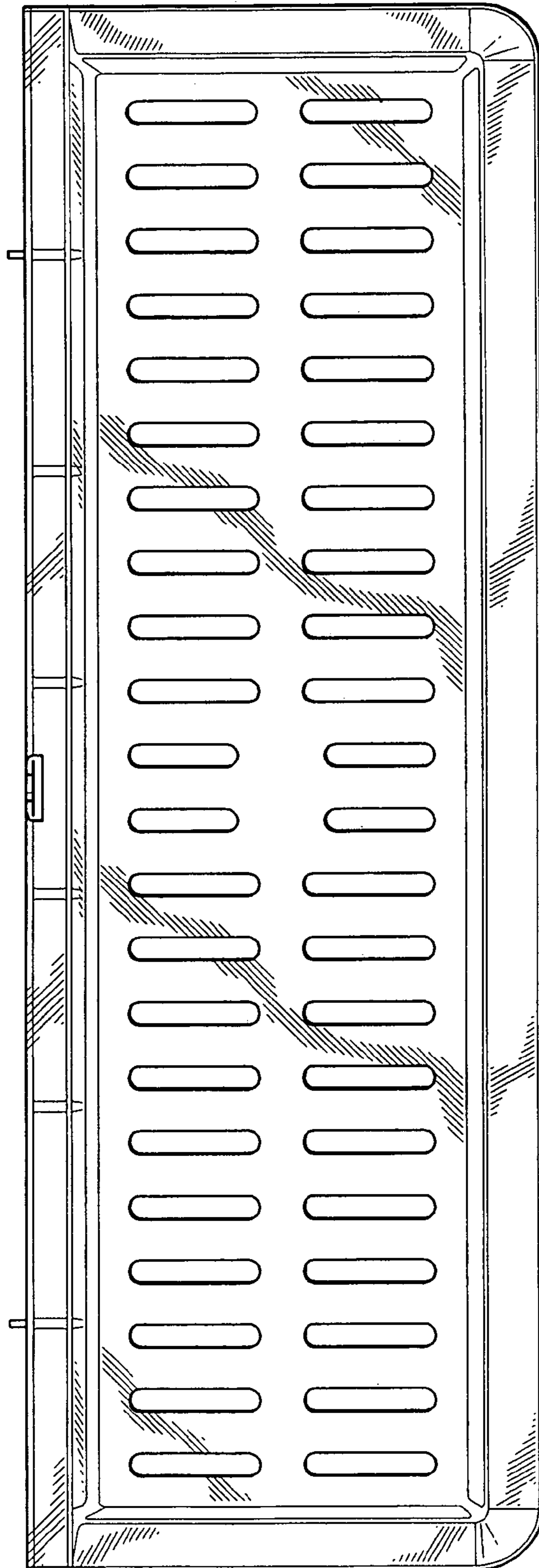

FIG. 5

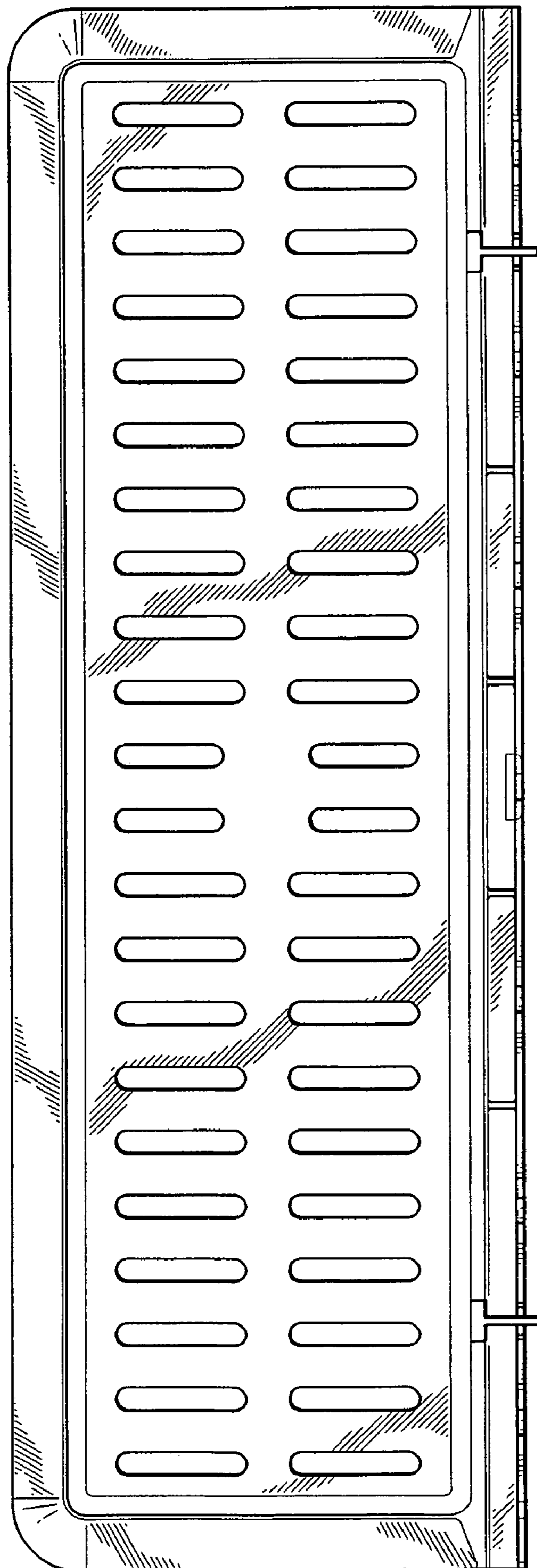

FIG. 6