

US00D547520S

(12) **United States Design Patent** (10) **Patent No.:** **US D547,520 S**
Perrier et al. (45) **Date of Patent:** **** Jul. 24, 2007**

(54) **CART HANDLE**

4,373,133 A 2/1983 Clyne et al.
4,500,880 A 2/1985 Gomersall et al.

(75) Inventors: **R. Sylvain Perrier**, Ottawa (CA);
Jeremy List, Ottawa, CA (US); **Cliff Read**, Carp (CA); **Jason Busschaert**,
Towson, MD (US); **Mark Edey**, Ottawa
(CA); **James D. Miller**, Holland
Landing (CA); **Howard W. Overland**,
Aurora (CA)

(Continued)

FOREIGN PATENT DOCUMENTS

GB 2307575 A 5/1997

(Continued)

OTHER PUBLICATIONS

Wincor Nixdorf; "SNIKEY"; www.wincor-nixdorf.com; Apr. 7,
2005.

(Continued)

(73) Assignee: **Springboard Retail Networks
Licensing SRL**, Barbados (KN)

(**) Term: **14 Years**

(21) Appl. No.: **29/269,359**

(22) Filed: **Nov. 30, 2006**

Primary Examiner—Freda S. Nunn
Assistant Examiner—Kevin K. Rudzinski
(74) *Attorney, Agent, or Firm*—Birch, Stewart, Kolasch &
Birch, LLP

Related U.S. Application Data

(62) Division of application No. 29/241,452, filed on Oct.
28, 2005.

(57) **CLAIM**

The ornamental design for a cart handle, as shown and
described.

(30) **Foreign Application Priority Data**

Apr. 29, 2005 (CA) 110969

DESCRIPTION

(51) **LOC (8) Cl.** **12-02**
(52) **U.S. Cl.** **D34/27**
(58) **Field of Classification Search** D34/12-27;
40/308, 506, 611; 280/33.991, 62, 47.17,
280/646, 33.992; D12/133; 403/312; 235/383
See application file for complete search history.

FIG. 1 is a front right perspective view of the cart handle;
FIG. 2 is a rear perspective view of the cart handle of FIG.
1;
FIG. 3 is a front elevation view of the cart handle of FIG. 1;
FIG. 4 is a rear elevation view of the cart handle of FIG. 1;
FIG. 5 is a top plan view of the cart handle of FIG. 1;
FIG. 6 is a bottom plan view of the cart handle of FIG. 1;
FIG. 7 is a right side view of the cart handle of FIG. 1; and,
FIG. 8 is a left side view of the cart handle of FIG. 1.

(56) **References Cited**

U.S. PATENT DOCUMENTS

2,759,281 A 8/1956 Akers, Jr.
3,251,543 A 5/1966 Bush
3,548,524 A * 12/1970 Rohnow 40/506
3,710,108 A 1/1973 Haarhaus et al.
3,836,755 A 9/1974 Ehrat et al.
4,071,740 A 1/1978 Gogulski
4,334,278 A 6/1982 Marmon

The broken line showing of the face, handle ends and back
is included for the purpose of illustrating only and forms no
part of the claimed design.

1 Claim, 5 Drawing Sheets

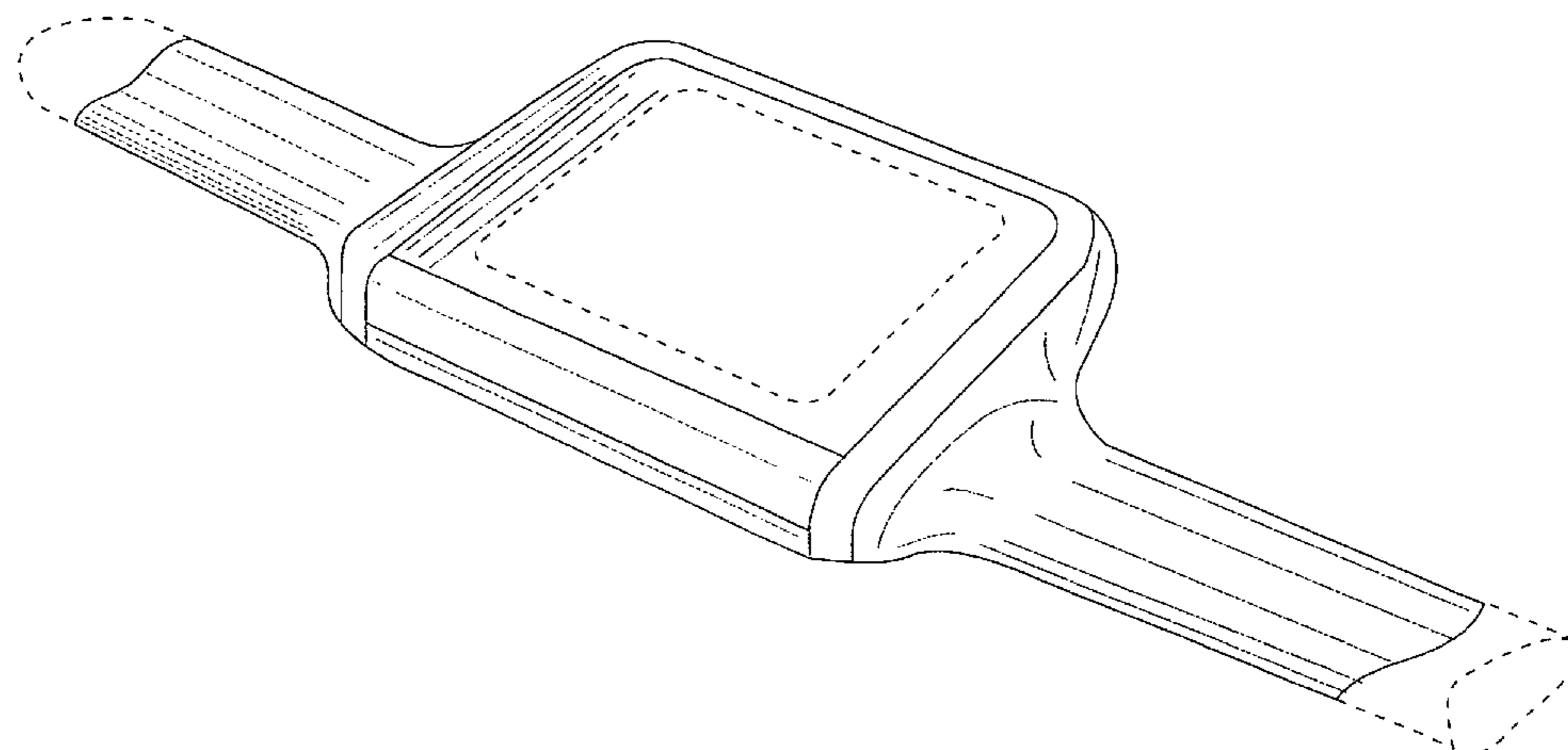

U.S. PATENT DOCUMENTS

D282,731 S * 2/1986 Kain D12/133
 D287,370 S * 12/1986 Stoll et al. D18/7
 4,750,151 A 6/1988 Baus
 4,882,724 A 11/1989 Vela et al.
 D305,173 S * 12/1989 Nozawa D34/27
 D307,895 S 5/1990 Kitagawa et al.
 4,973,952 A 11/1990 Malec et al.
 4,988,025 A 1/1991 Lipton et al.
 D321,577 S * 11/1991 Ellis et al. D34/21
 D328,607 S * 8/1992 Brennan D18/7
 5,149,947 A 9/1992 Collins, Jr.
 5,158,310 A 10/1992 Tannehill et al.
 5,250,789 A 10/1993 Johnsen
 D341,691 S 11/1993 Begum et al.
 5,287,266 A 2/1994 Malec et al.
 5,295,064 A 3/1994 Malec et al.
 D346,366 S 4/1994 Kim et al.
 5,301,443 A 4/1994 Gori
 D347,505 S 5/1994 Machen et al.
 D347,719 S 6/1994 Machen et al.
 D348,965 S * 7/1994 Machen et al. D34/15
 D354,485 S 1/1995 Maeno et al.
 5,406,271 A 4/1995 Sonnendorfer et al.
 5,420,606 A 5/1995 Begum et al.
 5,424,524 A 6/1995 Ruppert et al.
 5,457,307 A 10/1995 Dumont
 5,483,472 A 1/1996 Overman
 5,544,040 A 8/1996 Gerbaulet
 D375,601 S 11/1996 Myers et al.
 D376,459 S 12/1996 Myers
 5,630,068 A 5/1997 Vela et al.
 5,630,071 A 5/1997 Sakai et al.
 5,703,564 A 12/1997 Begum et al.
 D390,861 S 2/1998 Liao et al.
 5,714,745 A * 2/1998 Ju et al. 235/469
 D392,259 S 3/1998 Simmon
 5,729,697 A 3/1998 Schkolnick et al.
 5,739,513 A 4/1998 Watanabe
 5,773,954 A 6/1998 VanHorn
 5,821,512 A 10/1998 O'Hagan et al.
 5,821,513 A 10/1998 O'Hagan et al.
 5,836,051 A 11/1998 Myers
 5,841,115 A 11/1998 Shepley
 D404,761 S 1/1999 Tarpenning et al.
 5,859,414 A 1/1999 Grimes et al.
 5,890,135 A 3/1999 Powell
 5,898,158 A 4/1999 Shimizu et al.
 5,918,211 A 6/1999 Sloane
 5,979,757 A 11/1999 Tracy et al.
 5,984,182 A 11/1999 Murrah et al.
 6,000,610 A 12/1999 Talbott et al.
 6,012,244 A 1/2000 Begum et al.
 6,032,127 A 2/2000 Schkolnick et al.
 D425,681 S * 5/2000 Johnson et al. D34/27
 6,105,867 A 8/2000 Shimizu et al.
 6,112,857 A 9/2000 Morrison
 6,119,935 A 9/2000 Jelen et al.
 6,123,259 A 9/2000 Ogasawara
 6,129,276 A 10/2000 Jelen et al.
 6,168,079 B1 1/2001 Becker et al.
 6,177,880 B1 1/2001 Begum
 6,189,788 B1 2/2001 Sherman et al.
 D438,569 S * 3/2001 Hofmann D20/10
 D438,849 S 3/2001 Adachi et al.
 6,199,753 B1 3/2001 Tracy et al.
 D448,009 S * 9/2001 Lavelle et al. D14/125

6,323,753 B2 11/2001 Begum
 6,327,570 B1 12/2001 Stevens
 D454,563 S 3/2002 Brown et al.
 6,386,450 B1 5/2002 Ogasawara
 D460,759 S 7/2002 West et al.
 6,434,530 B1 8/2002 Sloane et al.
 6,435,407 B1 8/2002 Fiordelisi
 6,453,588 B1 9/2002 Lykens
 6,456,981 B1 9/2002 Dejaeger et al.
 D464,646 S 10/2002 Lin
 6,484,939 B1 11/2002 Blaeuer
 6,513,015 B2 1/2003 Ogasawara
 6,533,173 B2 3/2003 Benyak
 6,539,417 B2 3/2003 Stern
 6,595,417 B2 7/2003 O'Hagan et al.
 6,619,546 B1 9/2003 Nguyen et al.
 D480,760 S 10/2003 Wieth et al.
 D481,057 S 10/2003 Brady et al.
 D482,172 S 11/2003 Johnson et al.
 D482,836 S * 11/2003 Van Lingham, Jr. D34/27
 D483,361 S 12/2003 Yao et al.
 6,725,206 B1 4/2004 Coveley
 D492,303 S 6/2004 Schlieffers et al.
 D494,174 S * 8/2004 Hsu Li D14/374
 D494,970 S 8/2004 Chen et al.
 D495,703 S 9/2004 Ma et al.
 D495,707 S * 9/2004 Hoehn D14/374
 6,817,066 B1 * 11/2004 Williams et al. 16/435
 6,845,656 B2 1/2005 Matsumura et al.
 D501,888 S * 2/2005 Arceta D20/10
 6,854,656 B2 2/2005 Matsumori et al.
 6,910,697 B2 6/2005 Varatharajah et al.
 6,912,398 B1 6/2005 Domnitz
 6,928,343 B2 8/2005 Cato
 D509,827 S 9/2005 Johnson
 D510,784 S 10/2005 Van Lingham, Jr.
 D511,547 S 11/2005 Andersson et al.
 D528,146 S * 9/2006 Fitch D18/4.4
 2001/0007450 A1 7/2001 Begum
 2001/0028301 A1 10/2001 Geiger et al.
 2002/0165778 A1 11/2002 O'Hagan et al.
 2003/0132298 A1 7/2003 Swartz et al.
 2004/0073489 A1 4/2004 Varatharajah et al.
 2004/0215530 A1 10/2004 Rawson et al.
 2004/0262385 A1 * 12/2004 Blaeuer 235/383
 2005/0040230 A1 2/2005 Swartz et al.

FOREIGN PATENT DOCUMENTS

JP 2000-155683 6/2000
 WO WO-97/29452 8/1997

OTHER PUBLICATIONS

Wincor Nixdorf; "Beetle/NETPOS Scalable Thin Client Terminal"; www.wincor-nixdorf.com; Apr. 15, 2004.
 Wincor Nixdorf; "POS Terminal Beetle/IPOS"; www.wincor-nixdorf.com; Oct. 15, 2004.
 Klever Marketing; "Emarketing's Billion-Dollar Opportunity"; www.kleverkart.com; 2005; and Fujitsu; "The Fujitsu Difference—U-Scan Shopper"; www.fujitsu.com; 2005.
 Cuesol; "Enhancing the Customer Experience"; www.cuesol.com; 2005.
 Intermedia kiosks—news—Supermarket News, (Apr. 2001).
 Metro Group Future Store Initiative, Personal Shopping Assistant, www.future-store.org. Jan. 17, 2006.
 Interactive Store Guide and item locator for Deli Kiosk, www.dumac.com Jan. 19, 2002.

* cited by examiner

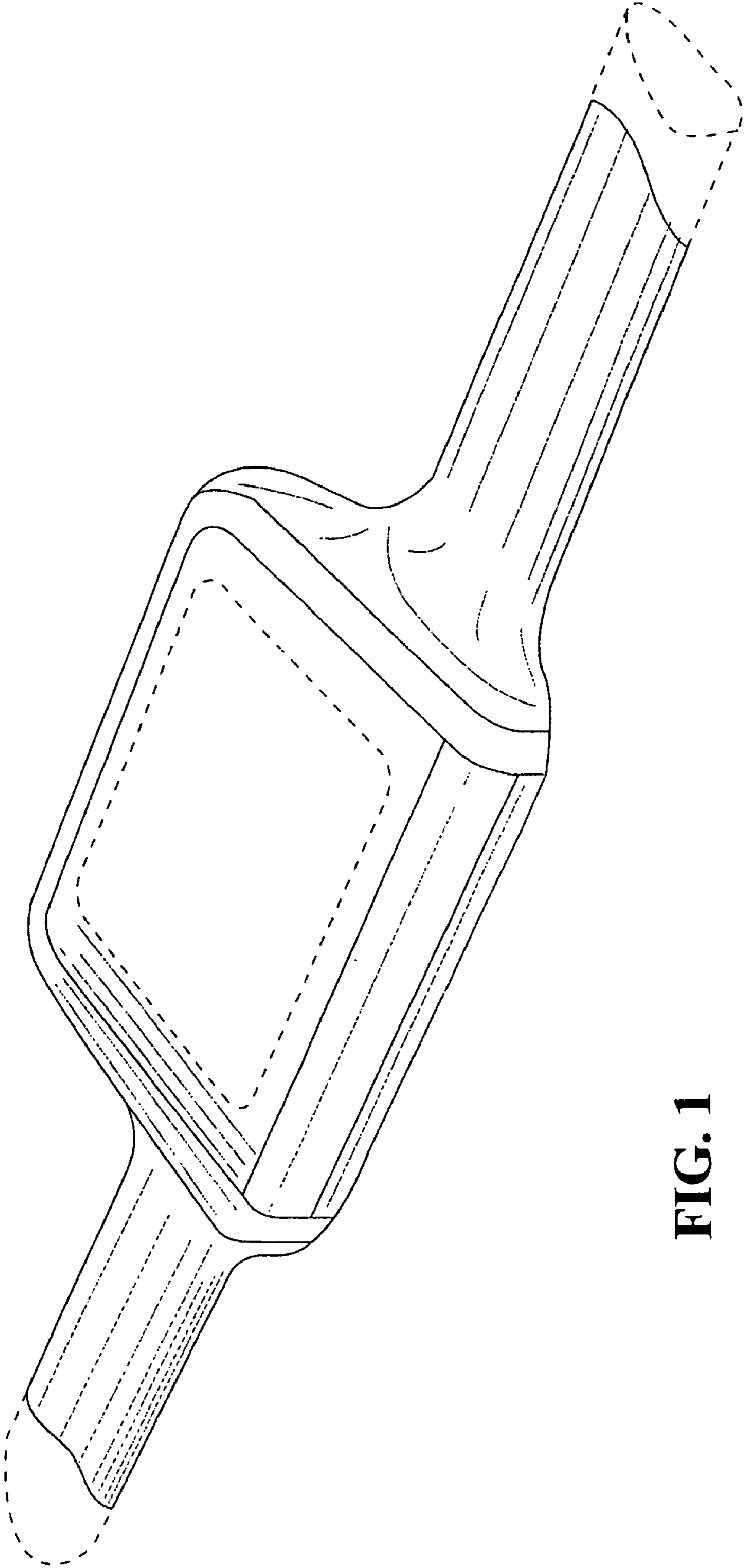

FIG. 1

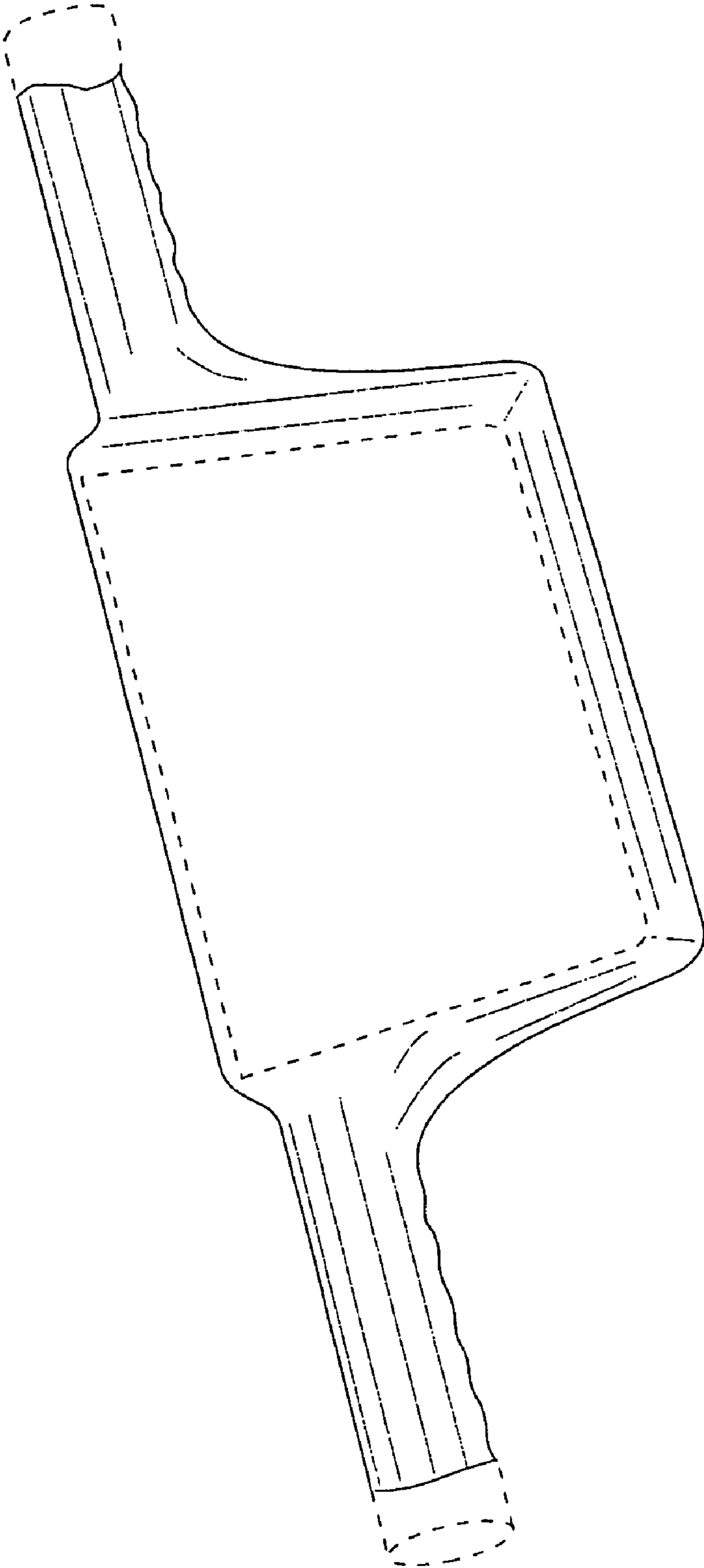

FIG. 2

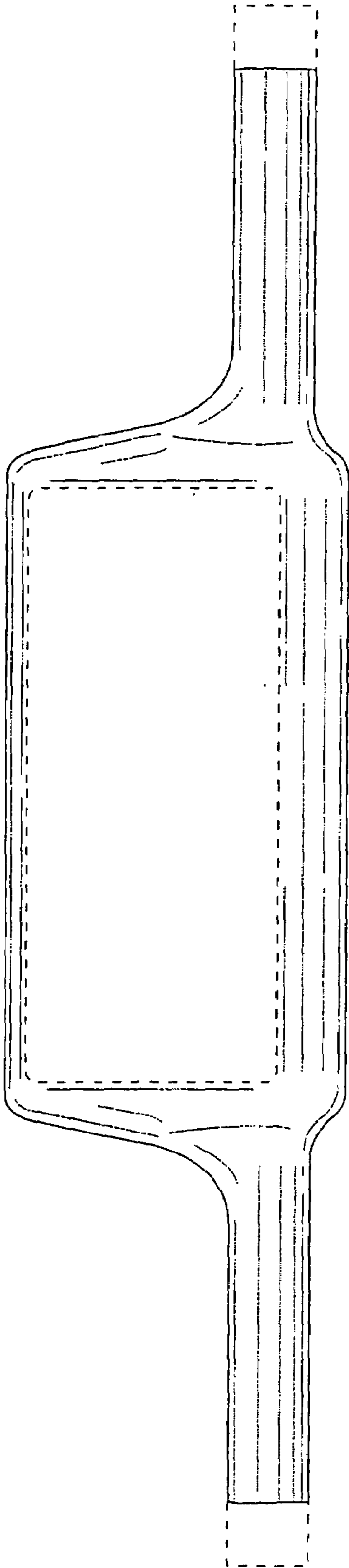

FIG. 3

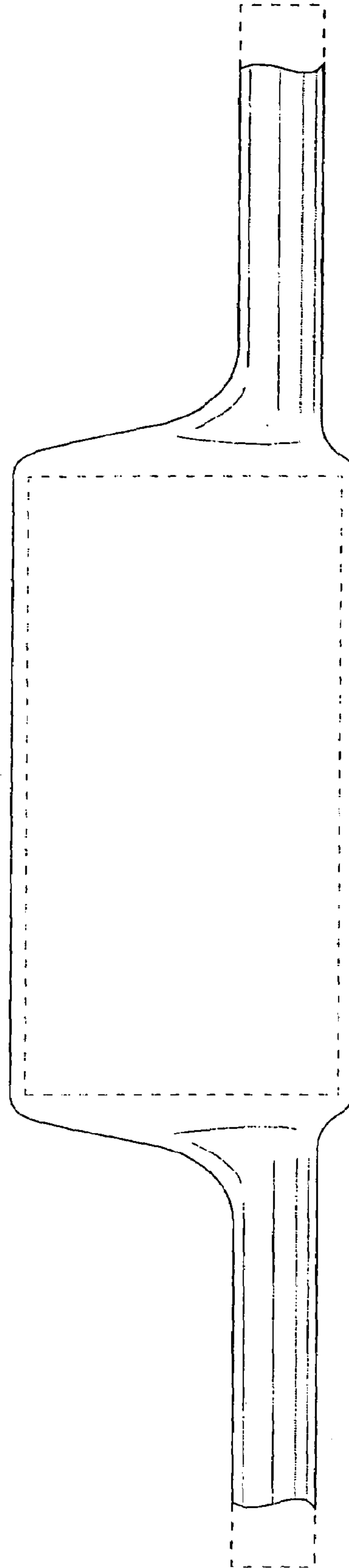

FIG. 4

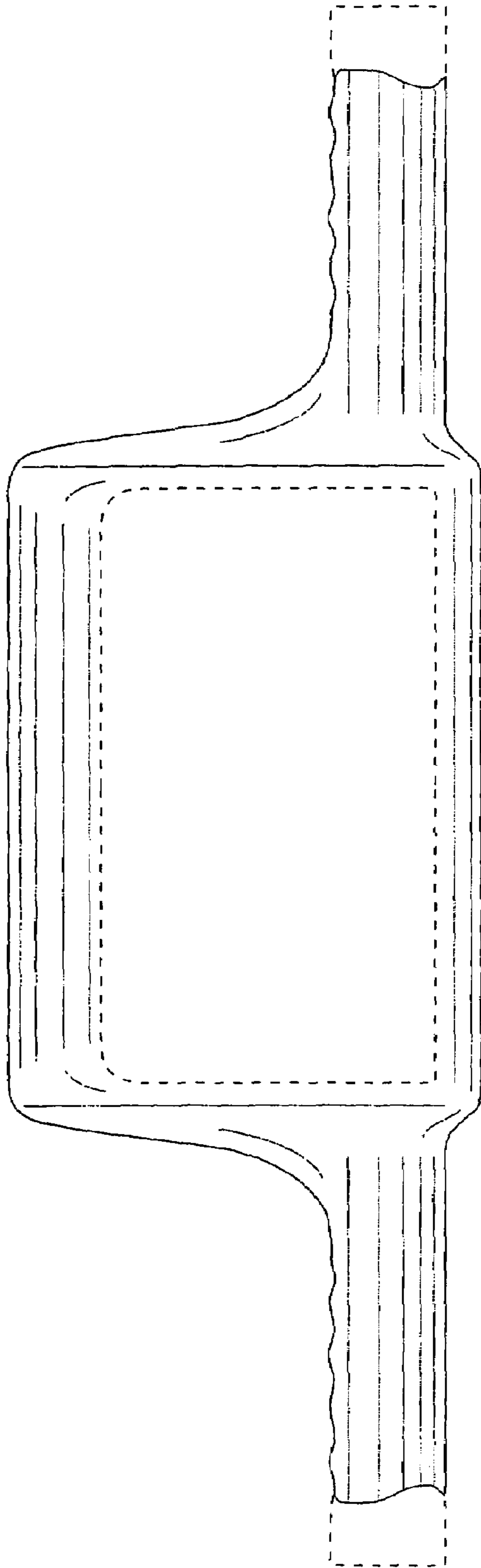

FIG. 5

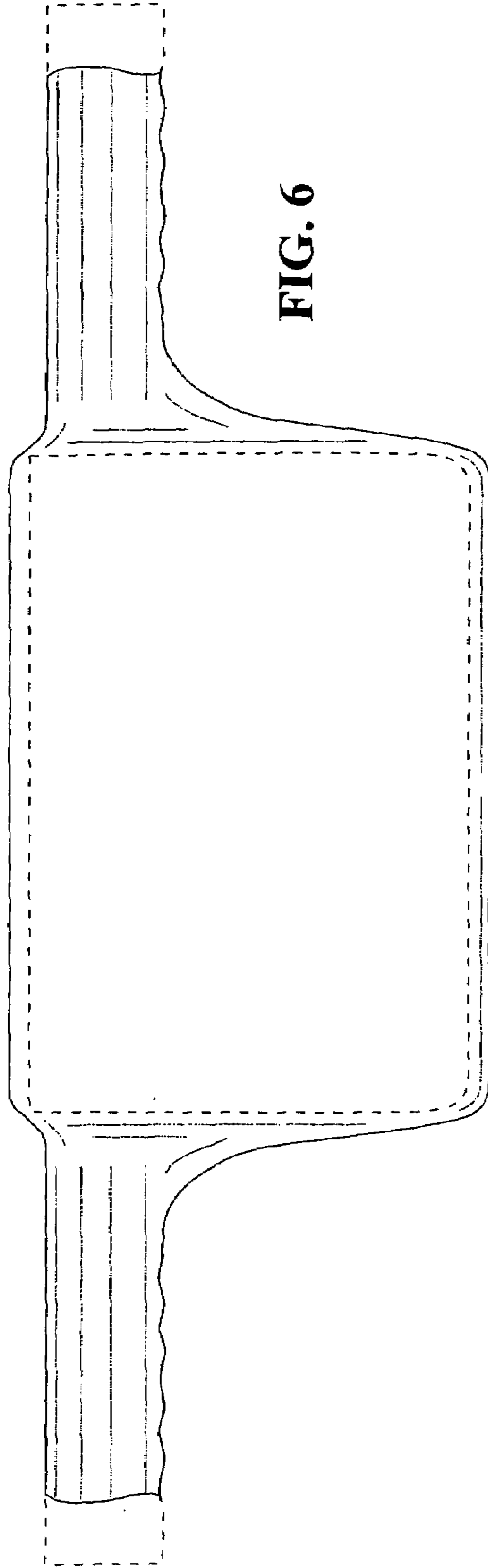

FIG. 6

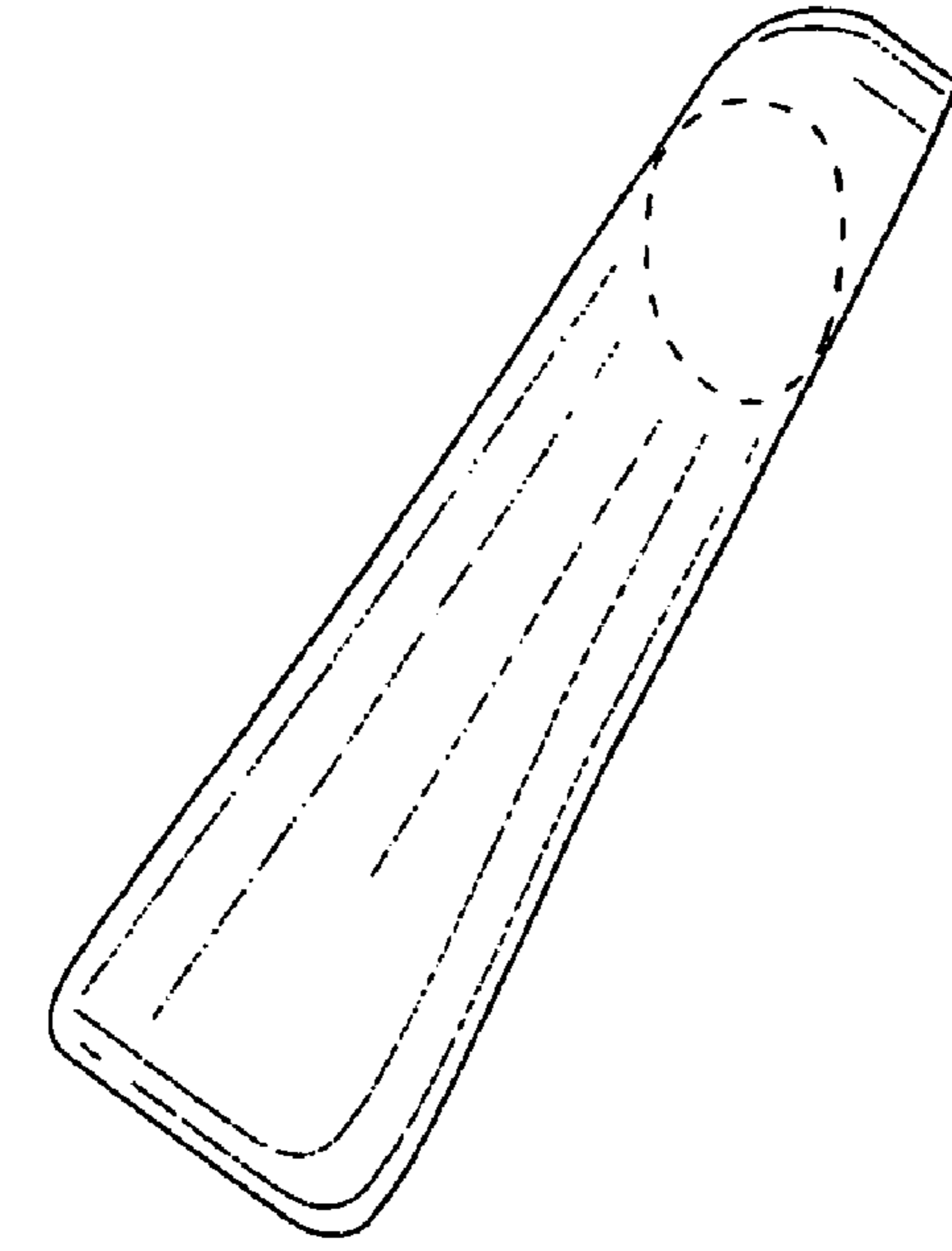

FIG. 7

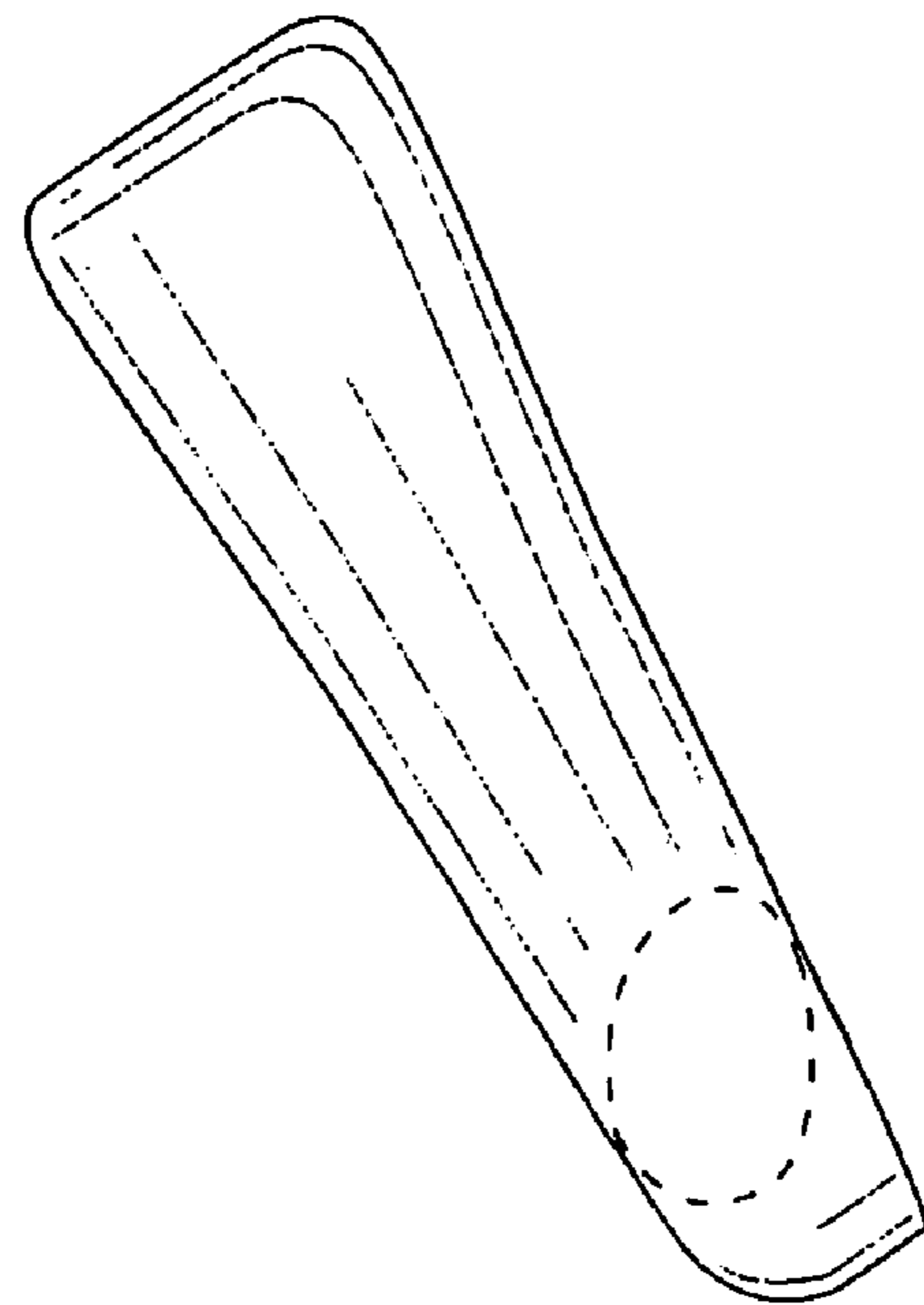

FIG. 8