



US00D547474S

(12) **United States Design Patent**
Chen et al.

(10) **Patent No.:** **US D547,474 S**

(45) **Date of Patent:** **** Jul. 24, 2007**

(54) **ELECTRIC TORCH**

(76) Inventors: **Shin-Fei Chen**, 216, Simen Rd.,
Yongjing Township, Changhua County
(TW); **Lu-Ling Zhao**, 2016, Wen Jin
Chung Rd., Lo Hu Dist., Shen Jiun,
Guang Dong (CN)

(**) Term: **14 Years**

(21) Appl. No.: **29/261,872**

(22) Filed: **Jun. 21, 2006**

(51) **LOC (8) Cl.** **26-02**

(52) **U.S. Cl.** **D26/37**

(58) **Field of Classification Search** D26/37,
D26/38, 40, 46, 41, 48, 51, 52, 49, 50; D8/308-400,
D8/300; 362/555, 183, 184, 200, 201, 208,
362/266, 267, 800, 612, 613, 158, 157, 171-174
See application file for complete search history.

(56) **References Cited**

U.S. PATENT DOCUMENTS

D311,067 S	*	10/1990	Chabria	D26/46
D314,243 S	*	1/1991	Ueda	D26/28
D346,230 S	*	4/1994	Ueda	D26/28
D435,675 S	*	12/2000	Sinclair	D26/37
D453,580 S	*	2/2002	Lynch et al.	D26/46
D496,479 S	*	9/2004	Ashfield	D26/37
D509,611 S	*	9/2005	Chou	D26/37

D511,586 S	*	11/2005	Yeh	D26/37
D520,160 S	*	5/2006	Lee	D26/37
D528,676 S	*	9/2006	Leslie et al.	D26/28
D529,212 S	*	9/2006	Yuen	D26/37
D532,915 S	*	11/2006	Yuen	D26/38

* cited by examiner

Primary Examiner—Ian Simmons

Assistant Examiner—Carissa Fitts

(74) *Attorney, Agent, or Firm*—Alan Kamrath; Kamrath &
Associates PA

(57) **CLAIM**

The ornamental design for a electric torch, as shown and
described.

DESCRIPTION

FIG. 1 is a perspective view of a electric torch showing my
design;

FIG. 2 is a front elevational view thereof;

FIG. 3 is a rear elevational view thereof;

FIG. 4 is a left side elevational view thereof;

FIG. 5 is a right side elevational view thereof;

FIG. 6 is a top plan view thereof; and,

FIG. 7 is a bottom plan view thereof.

1 Claim, 4 Drawing Sheets

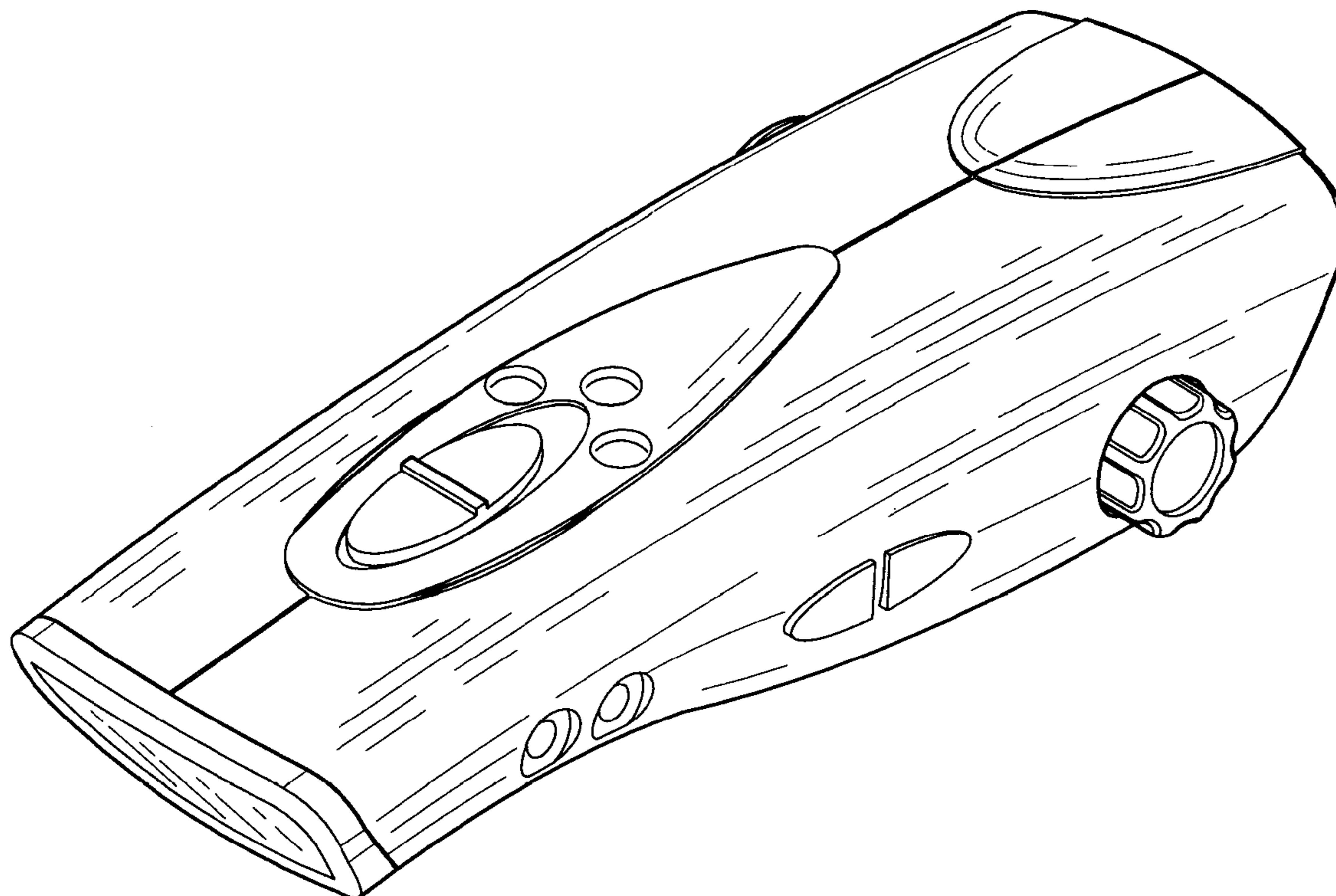

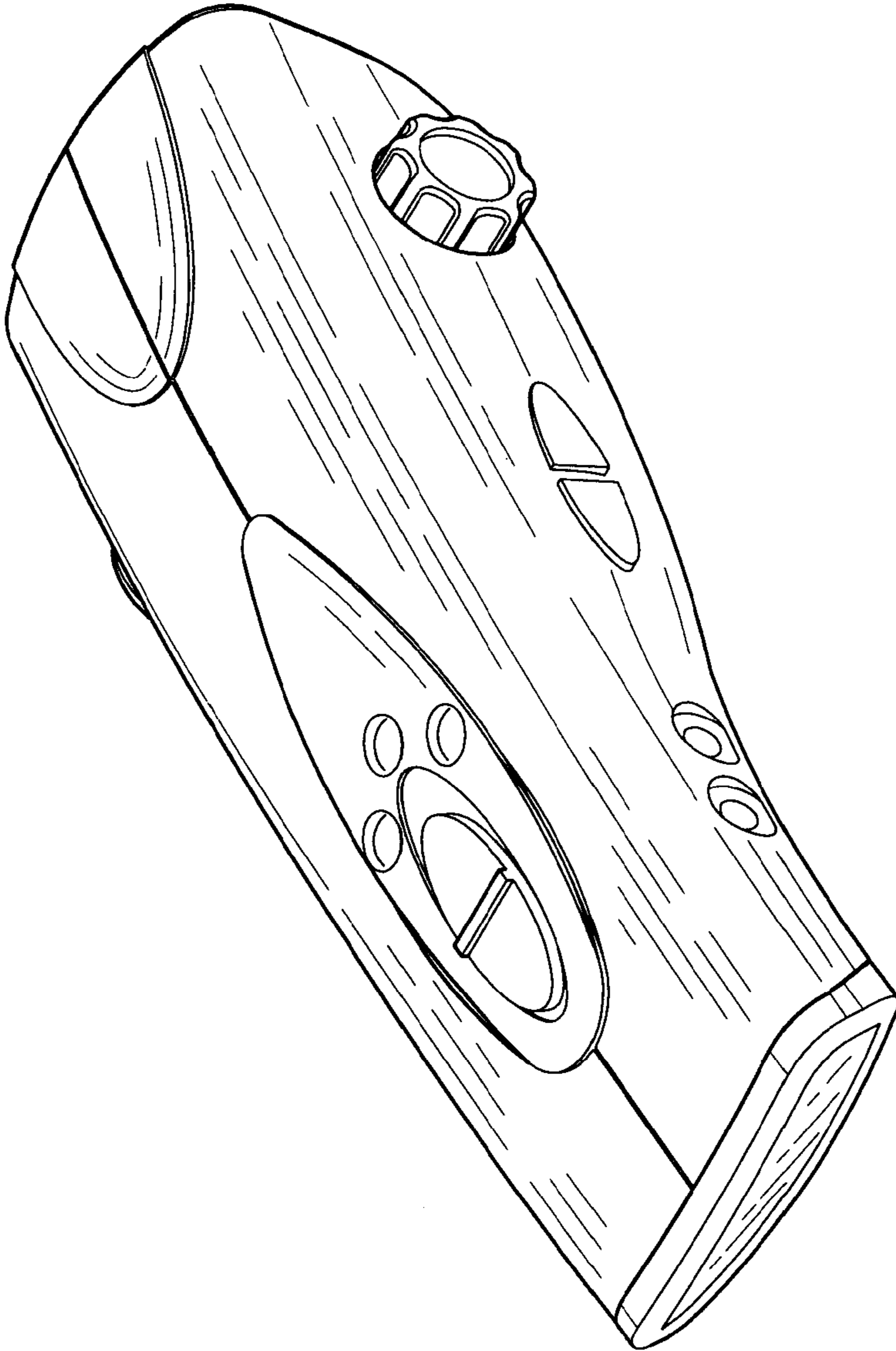

FIG. 1

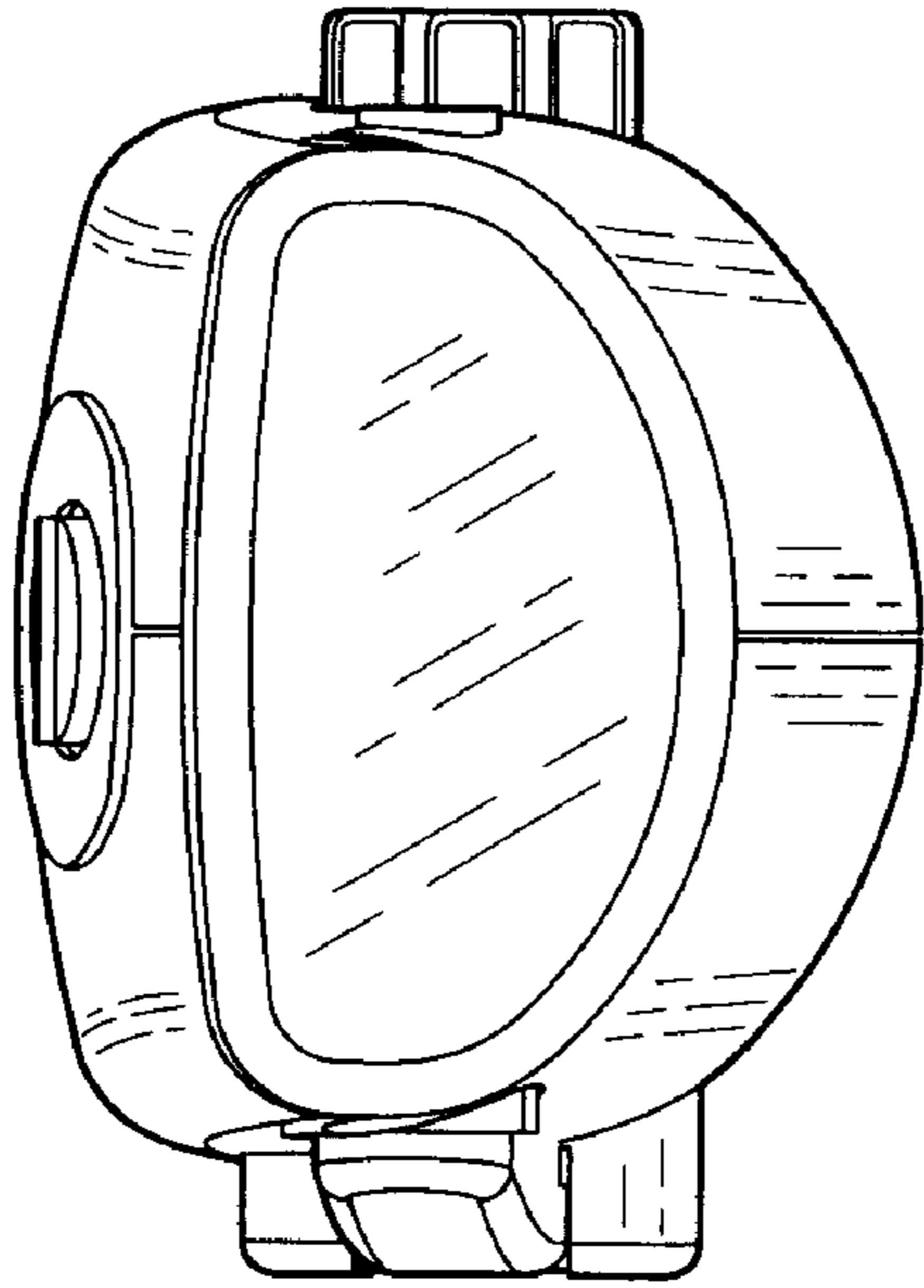

FIG. 2

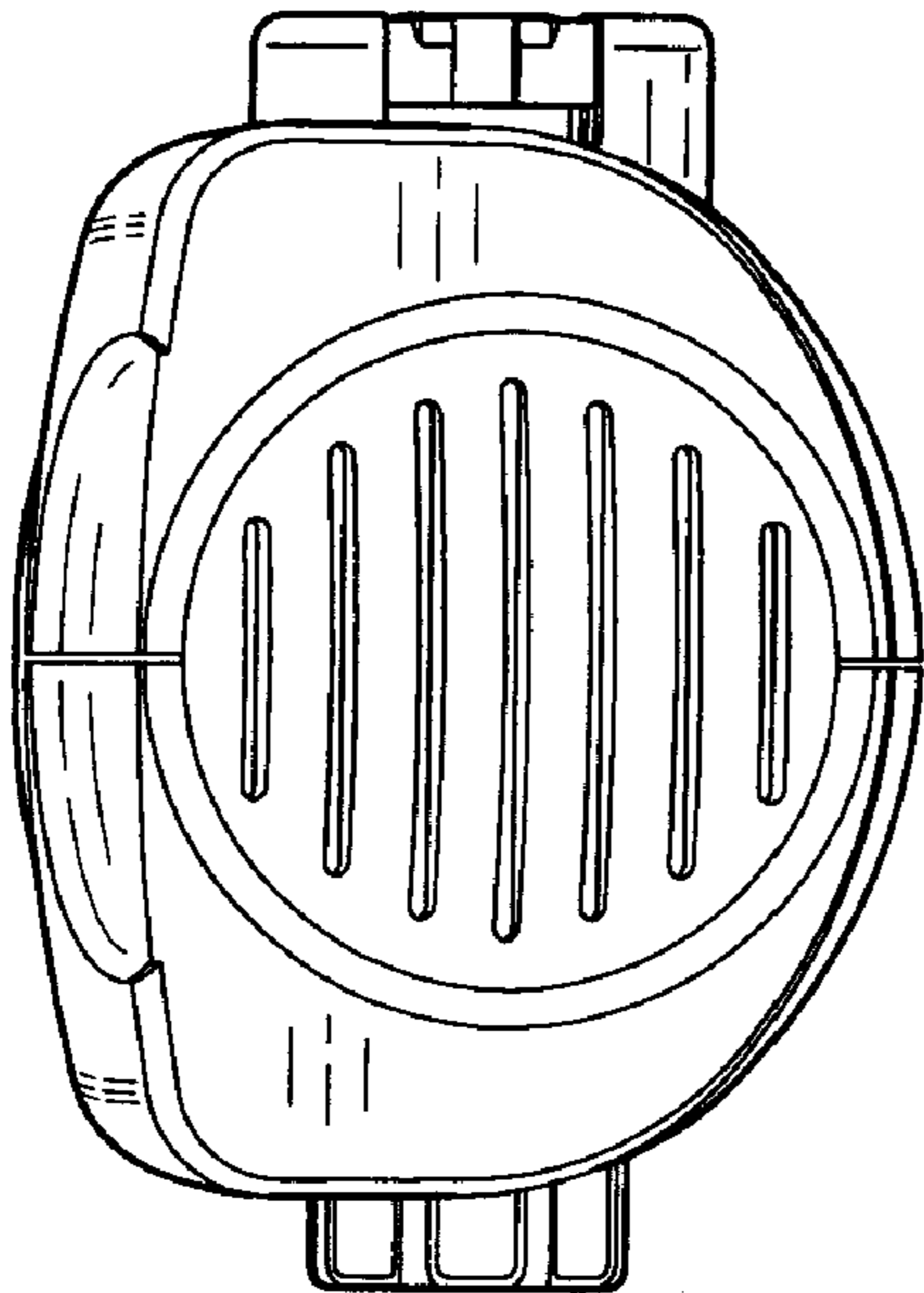

FIG. 3

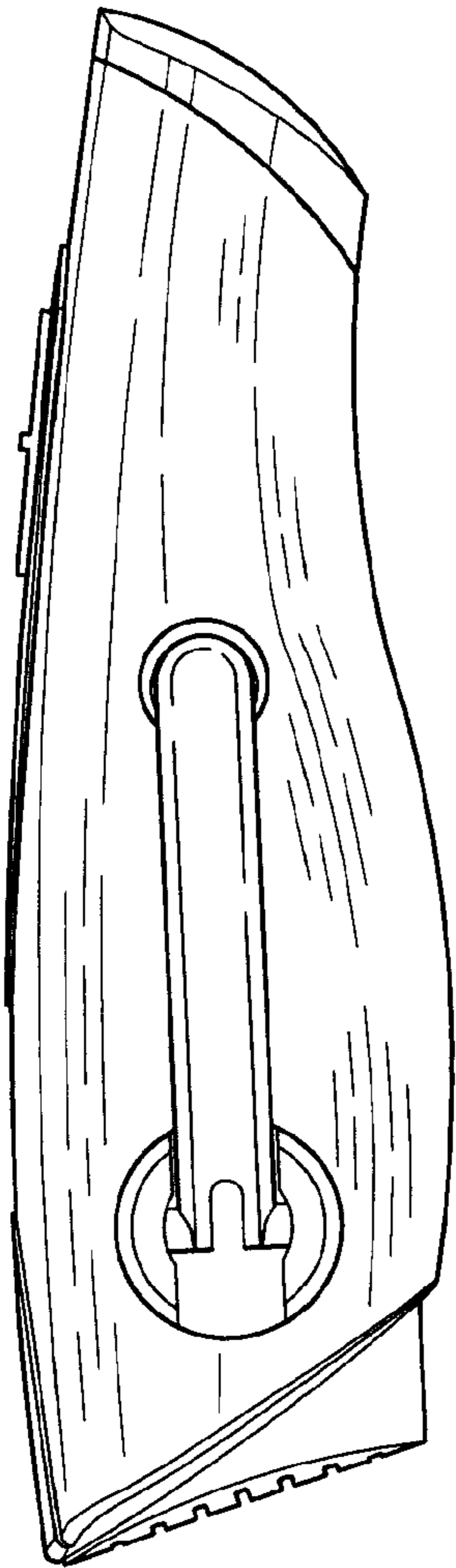

FIG. 4

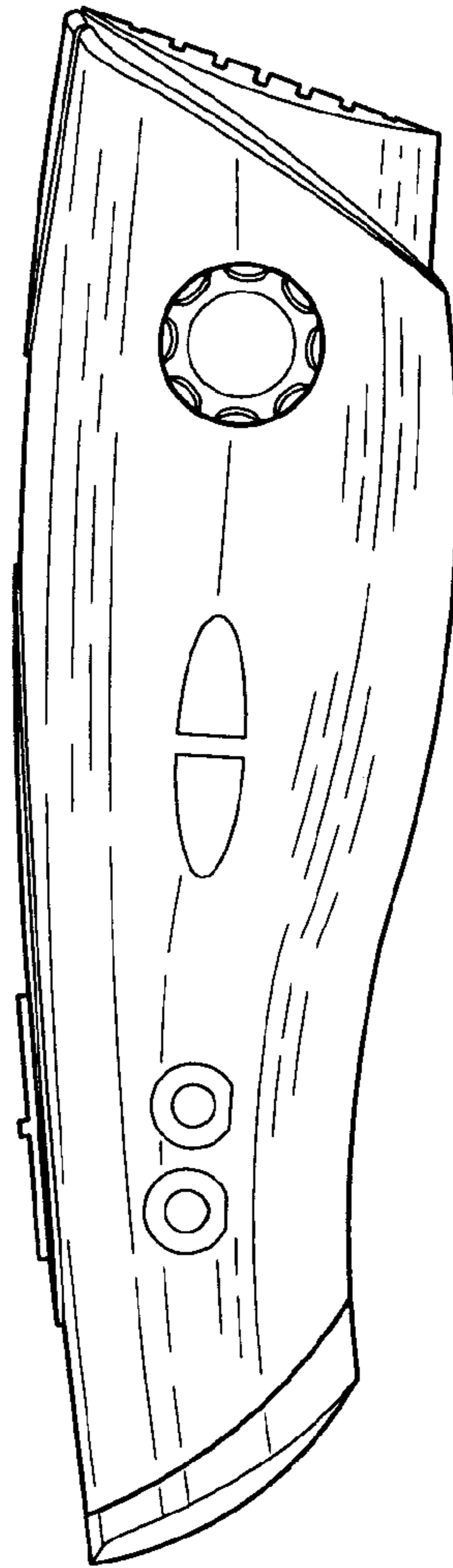

FIG. 5

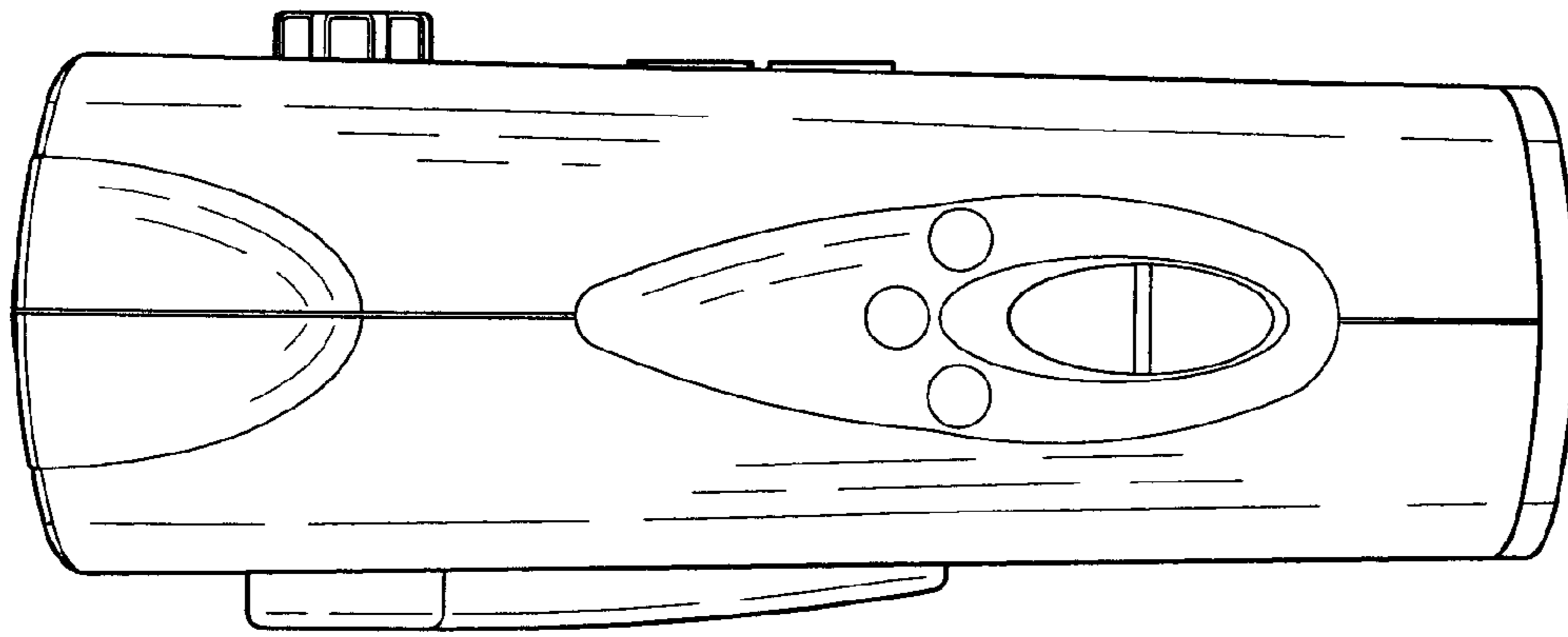

FIG. 6

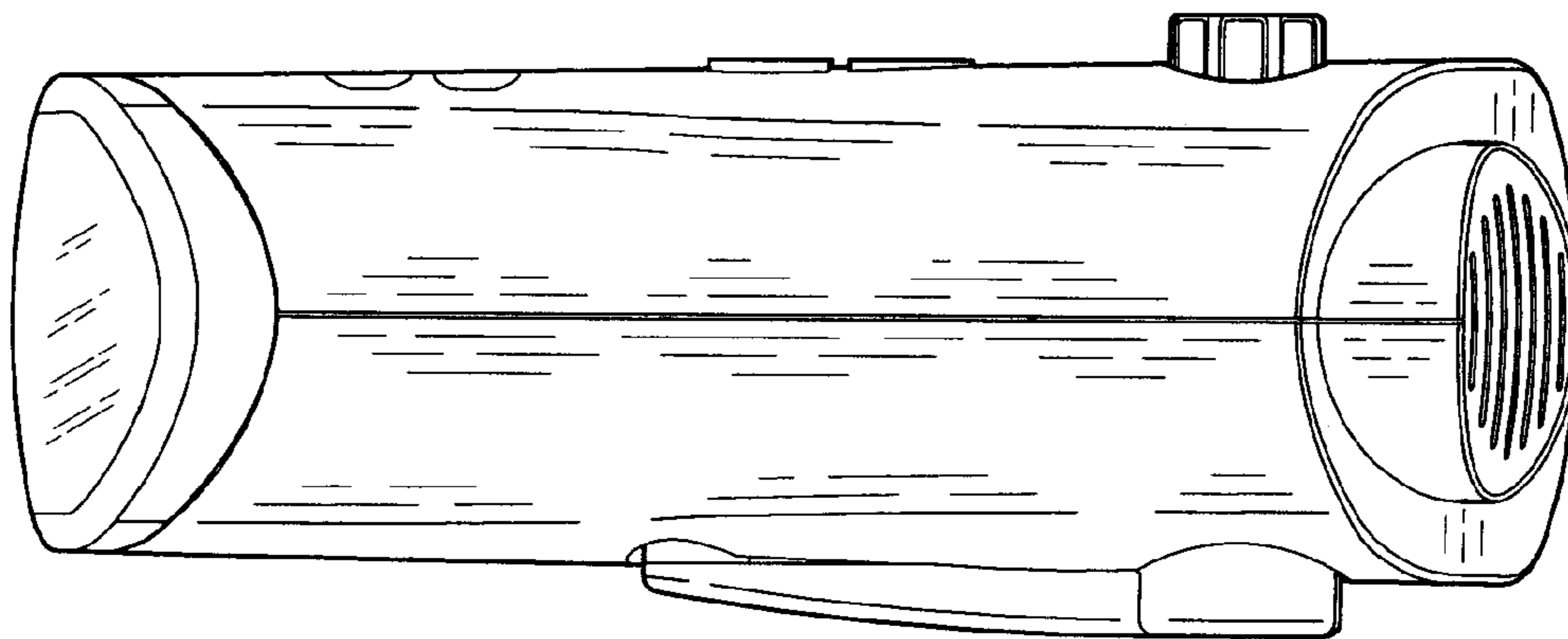

FIG. 7