



US00D547375S

(12) **United States Design Patent**
Gerules

(10) **Patent No.:** **US D547,375 S**

(45) **Date of Patent:** **** Jul. 24, 2007**

(54) **WRITING INSTRUMENT**

(75) Inventor: **Matthew Justin Gerules**, Chicago, IL
(US)

(73) Assignee: **Sanford, L.P.**, Oak Brook, IL (US)

(**) Term: **14 Years**

(21) Appl. No.: **29/242,712**

(22) Filed: **Nov. 14, 2005**

(51) **LOC (8) Cl.** **19-06**

(52) **U.S. Cl.** **D19/51**

(58) **Field of Classification Search** D19/35,
D19/36, 41-51, 54-57; 24/11 R, 11 F, 11 P;
401/52, 99, 100, 104, 105, 106, 107, 108,
401/109, 192, 195, 196

See application file for complete search history.

(56) **References Cited**

U.S. PATENT DOCUMENTS

D221,265 S *	7/1971	Wakai	D19/47
D252,333 S *	7/1979	Funahashi	D19/47
D258,217 S *	2/1981	Sakaoka	D19/49
D266,769 S *	11/1982	Camps	D19/51
D323,529 S *	1/1992	Rousseau	D19/51
D330,217 S *	10/1992	Booker	D19/48
D410,029 S *	5/1999	Melnick	D19/36
D440,601 S *	4/2001	Sasaki	D19/43
D467,614 S *	12/2002	Pellissa Beneyto	D19/51
D467,970 S *	12/2002	Pellissa Beneyto	D19/43
D478,350 S *	8/2003	Furlong	D19/43
D484,186 S *	12/2003	Monti	D19/43
D490,464 S *	5/2004	Andrews et al.	D19/43
D500,338 S *	12/2004	Kommer	D19/43
D525,303 S *	7/2006	Andrews et al.	D19/51

* cited by examiner

Primary Examiner—Elizabeth A. Albert

(74) *Attorney, Agent, or Firm*—Marshall, Gerstein & Borun
LLP

(57) **CLAIM**

The ornamental design for a writing instrument, as shown
and described.

DESCRIPTION

FIG. 1 is a perspective view showing my new design for a
writing instrument;

FIG. 2 is a right side elevational view of the writing
instrument of FIG. 1;

FIG. 3 is a front view of the writing instrument of FIG. 1;

FIG. 4 is a rear view of the writing instrument of FIG. 1;

FIG. 5 is a top plan view of the writing instrument of FIG.
1;

FIG. 6 is a bottom plan view of the writing instrument of
FIG. 1;

FIG. 7 is a perspective view of the writing instrument of
FIG. 1 with the cap in a stored position;

FIG. 8 is a right side elevational view of the writing
instrument of FIG. 7;

FIG. 9 is a front view of the writing instrument of FIG. 7;

FIG. 10 is a rear view of the writing instrument of FIG. 7;

FIG. 11 is a top plan view of the writing instrument of FIG.
7;

FIG. 12 is a bottom plan view of the writing instrument of
FIG. 7; and,

FIG. 13 is an exploded view of the writing instrument of
FIG. 1.

The dashed lines are for illustrative purposes only and form
no part of the claimed design.

1 Claim, 4 Drawing Sheets

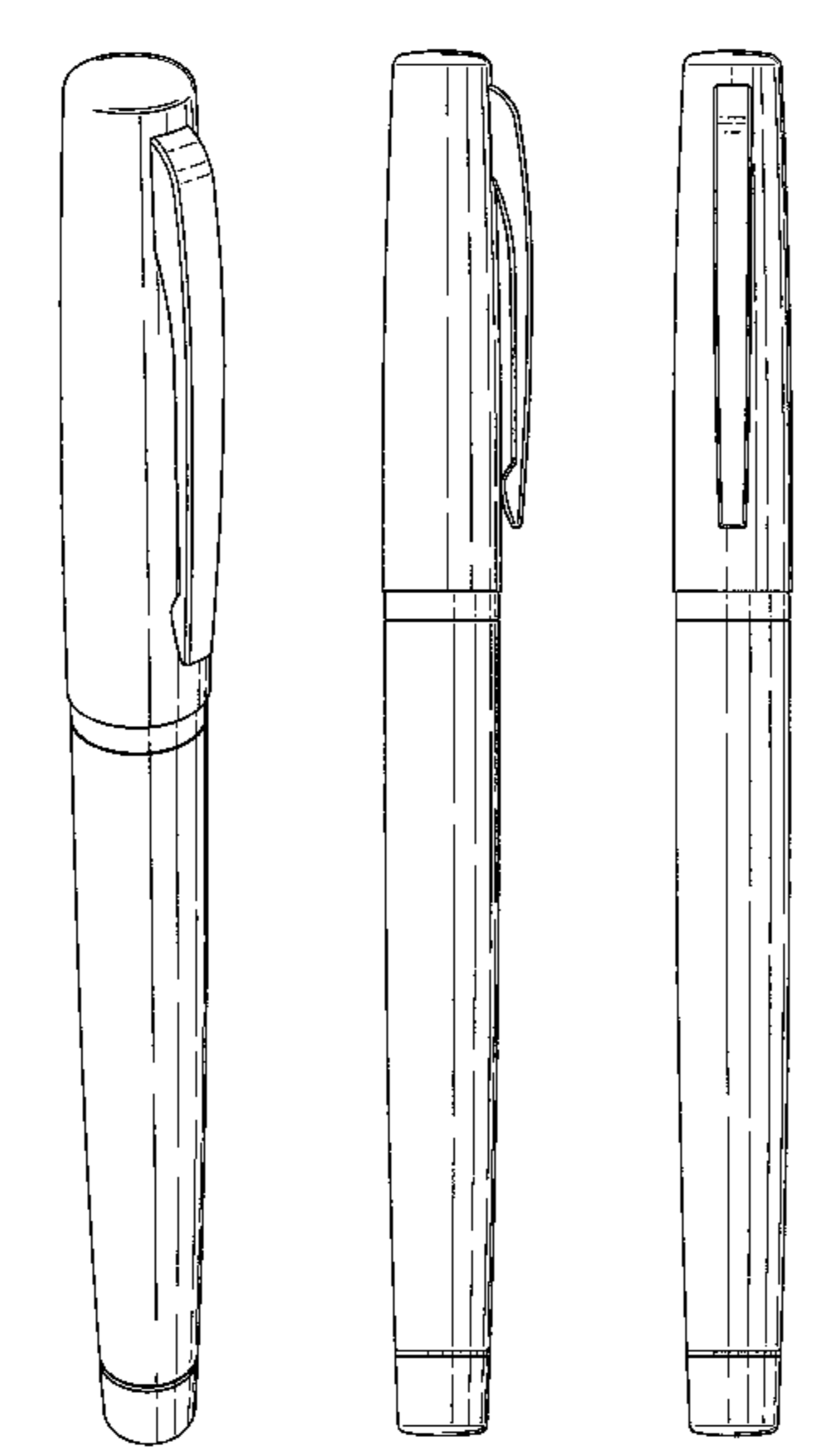

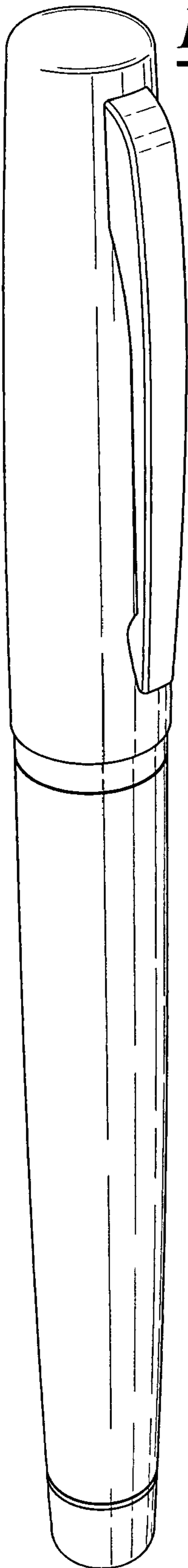

FIG. 1

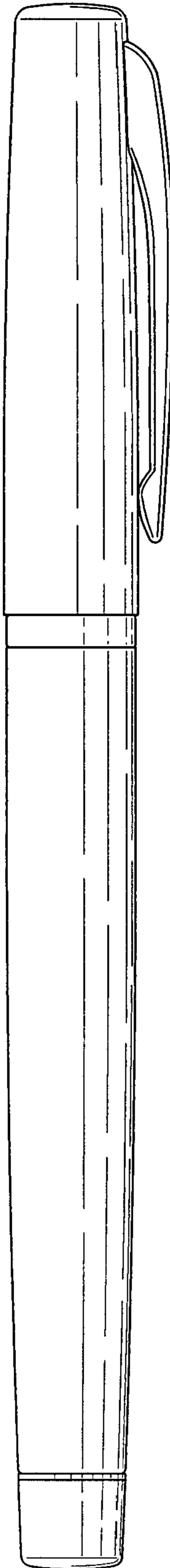
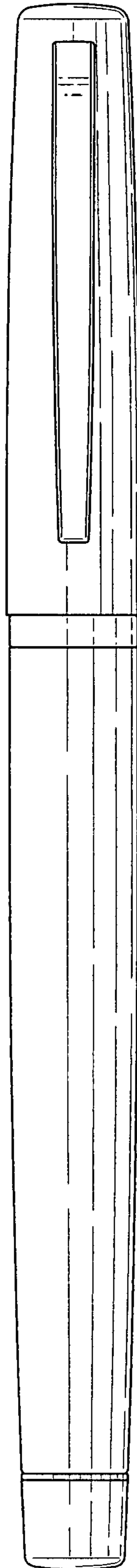

FIG. 2

FIG. 3



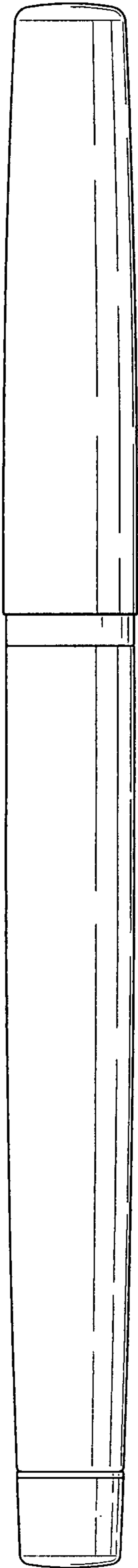

FIG. 4

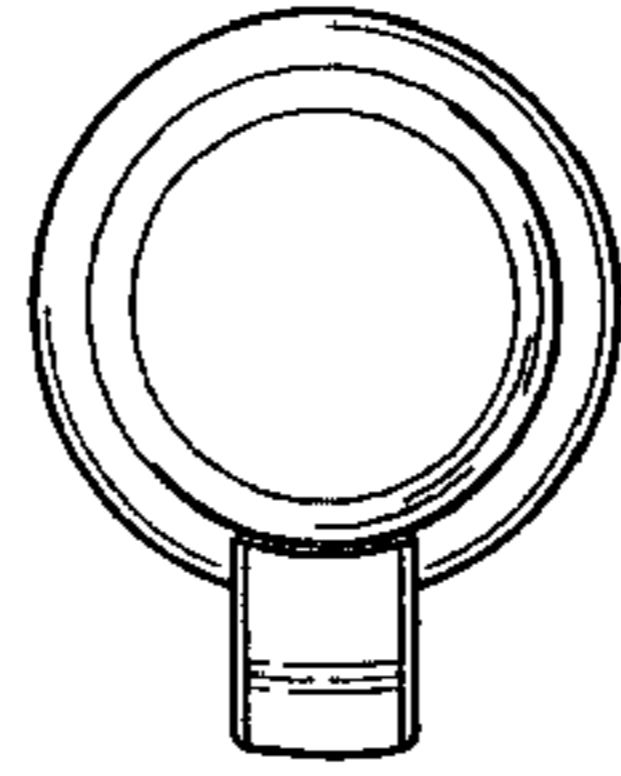

FIG. 5

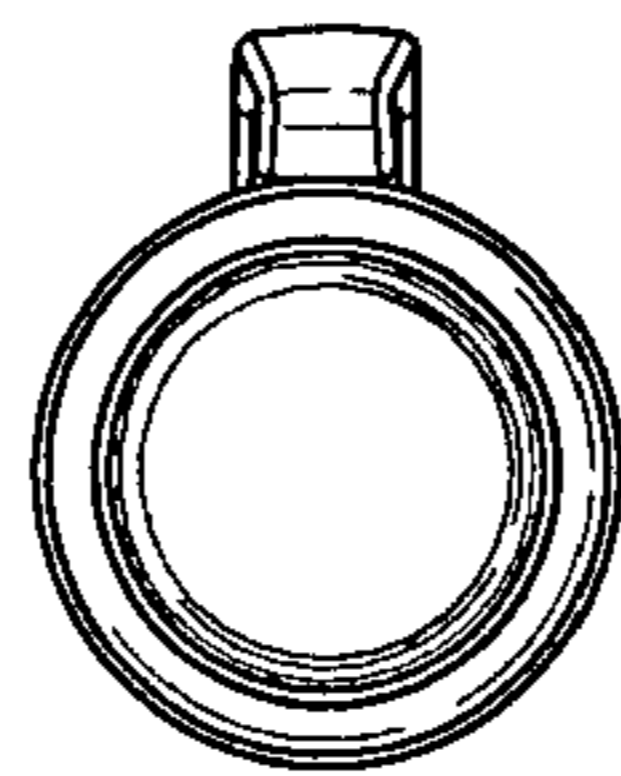

FIG. 6

FIG. 7

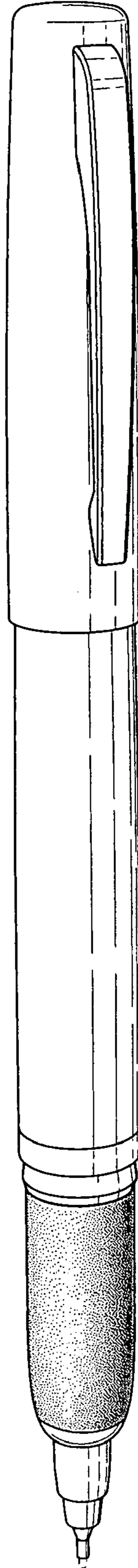



FIG. 8

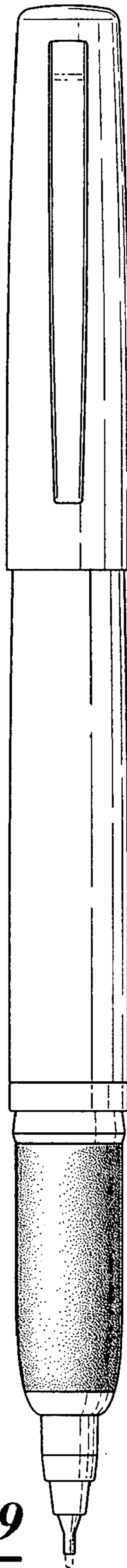

FIG. 9

FIG. 10

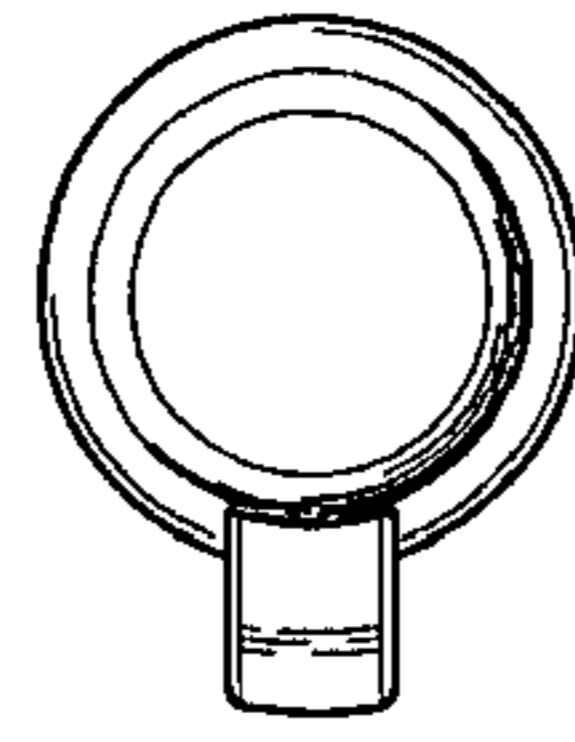

FIG. 11

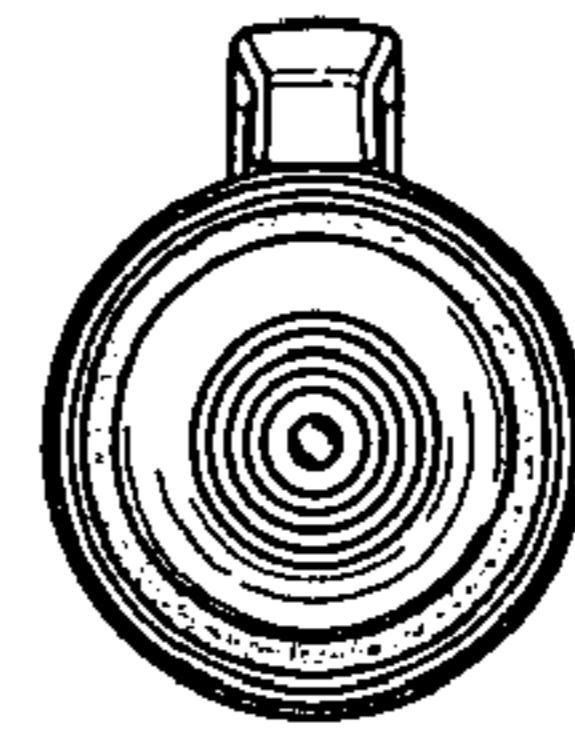

FIG. 12

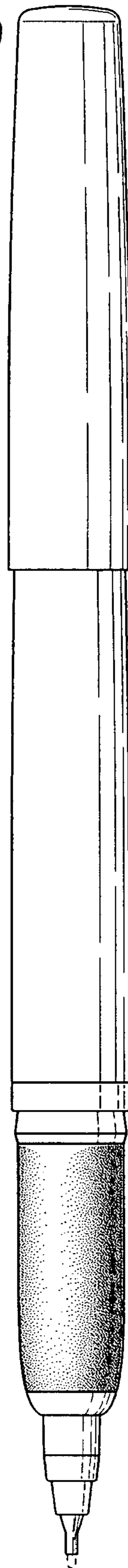

FIG. 13

