



US00D547348S

(12) **United States Design Patent**
Kashiwagi et al.

(10) **Patent No.:** **US D547,348 S**

(45) **Date of Patent:** **** Jul. 24, 2007**

(54) **CAMERA**

(75) Inventors: **Nobuhiko Kashiwagi**, Kanagawa (JP);
Makoto Isozaki, Tokyo (JP)

(73) Assignee: **Fujifilm Corporation**, Tokyo (JP)

(**) Term: **14 Years**

(21) Appl. No.: **29/252,591**

(22) Filed: **Jan. 26, 2006**

(30) **Foreign Application Priority Data**

Jul. 29, 2005 (JP) 2005-022130

(51) **LOC (8) Cl.** **16-01**

(52) **U.S. Cl.** **D16/208; D16/209**

(58) **Field of Classification Search** D16/200–205,
D16/208–209, 134, 136, 216–219; 348/373–376;
358/906, 909.1; 359/815, 819, 826–828;
396/6, 176–177, 354–359, 535–541, 529–532
See application file for complete search history.

(56) **References Cited**

U.S. PATENT DOCUMENTS

D372,722 S *	8/1996	Isozaki	D16/208
D425,093 S *	5/2000	Chang	D16/209
D436,610 S *	1/2001	Kondo	D16/209
6,175,690 B1 *	1/2001	Chung et al.	396/176
6,222,995 B1 *	4/2001	Uchida	396/6
D454,359 S *	3/2002	Katayama	D16/208
D457,907 S *	5/2002	Kondo	D16/209
D460,098 S	7/2002	Katayama		
D460,473 S	7/2002	Katayama		
D460,774 S	7/2002	Katayama		
D475,388 S	6/2003	Kondo		

D478,924 S *	8/2003	Kibayashi	D16/209
D479,727 S *	9/2003	Horikiri	D16/218
D481,055 S	10/2003	Senda		
6,714,728 B2 *	3/2004	Moriya et al.	396/176
6,741,806 B2 *	5/2004	Mikami et al.	396/6
D490,834 S *	6/2004	Dow et al.	D16/202
6,771,900 B2 *	8/2004	Moriya et al.	396/176

* cited by examiner

Primary Examiner—Ian Simmons

Assistant Examiner—Wan Laymon

(74) *Attorney, Agent, or Firm*—Young & Thompson

(57) **CLAIM**

The ornamental design for a camera, as shown and described.

DESCRIPTION

FIG. 1 is a top, front and side perspective view of a camera showing our new design;

FIG. 2 is a front elevational view thereof;

FIG. 3 is a rear elevational view thereof;

FIG. 4 is a top plan view thereof;

FIG. 5 is a bottom plan view thereof;

FIG. 6 is a side elevational view thereof from the left of FIG. 2;

FIG. 7 is a side elevational view thereof from the right of FIG. 2; and,

FIG. 8 is a top, front and side perspective view thereof, with the signaling light guide, indicator disk and light reducing panel shown in a lower position.

1 Claim, 4 Drawing Sheets

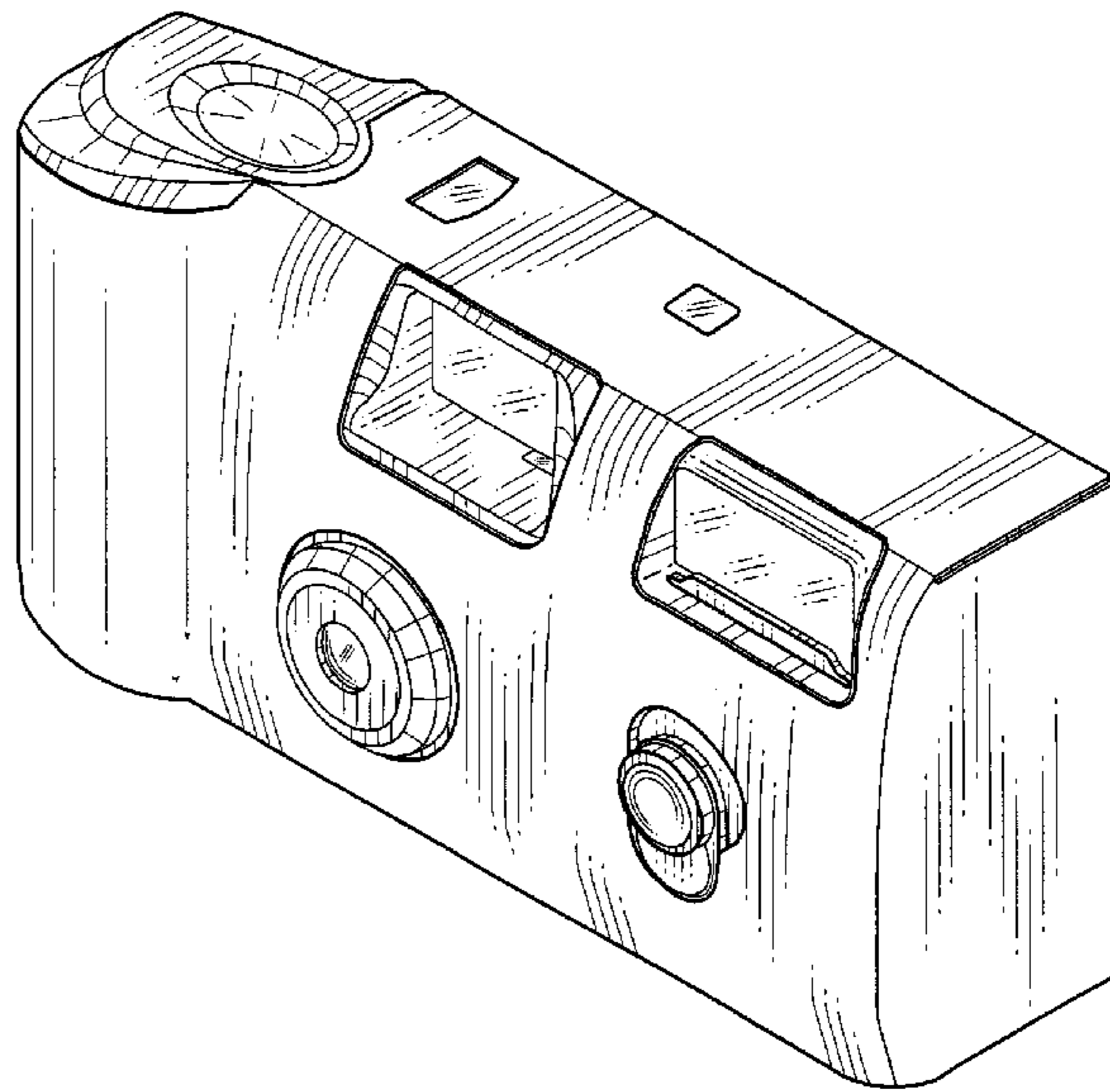
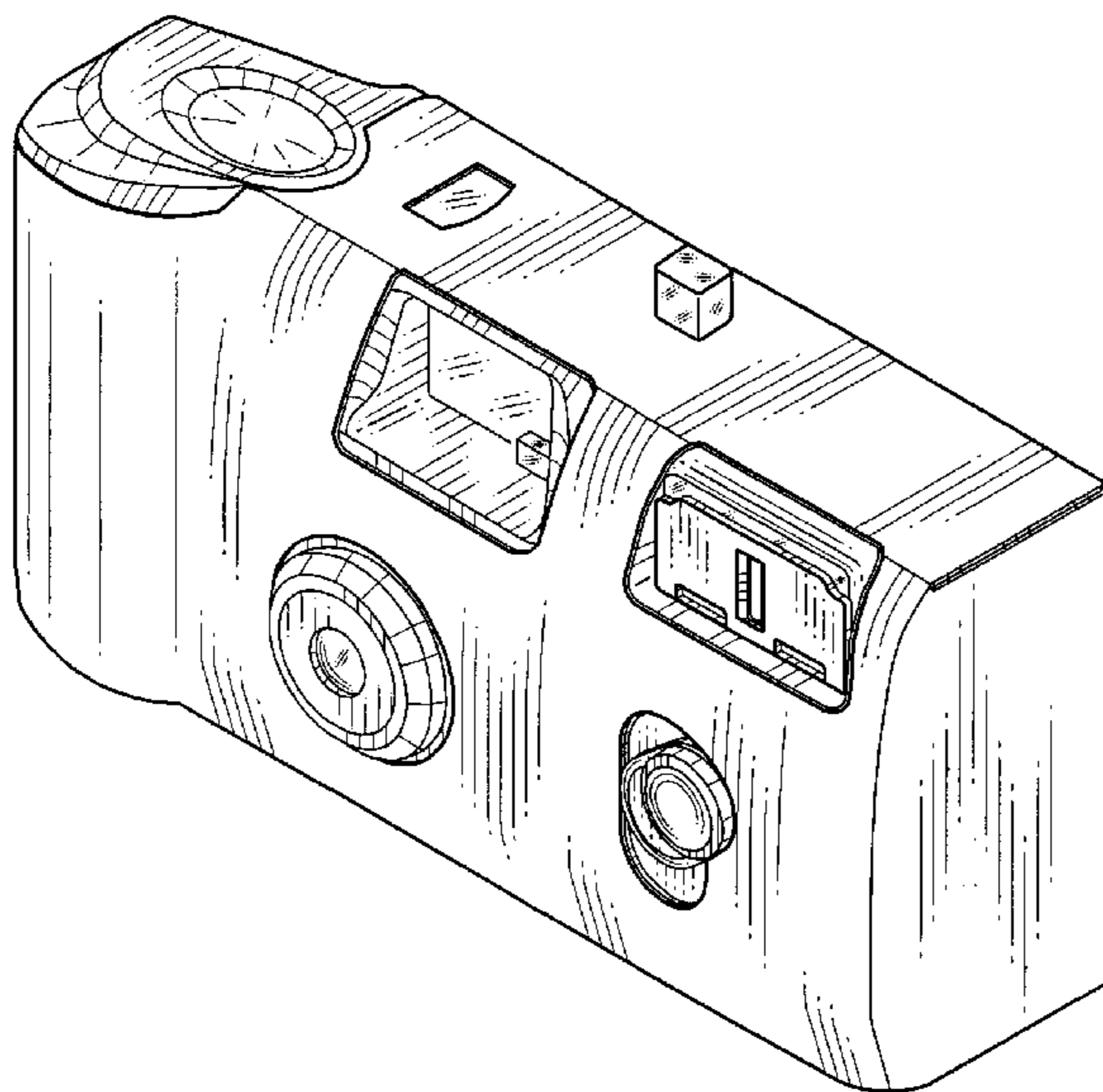

FIG. 1

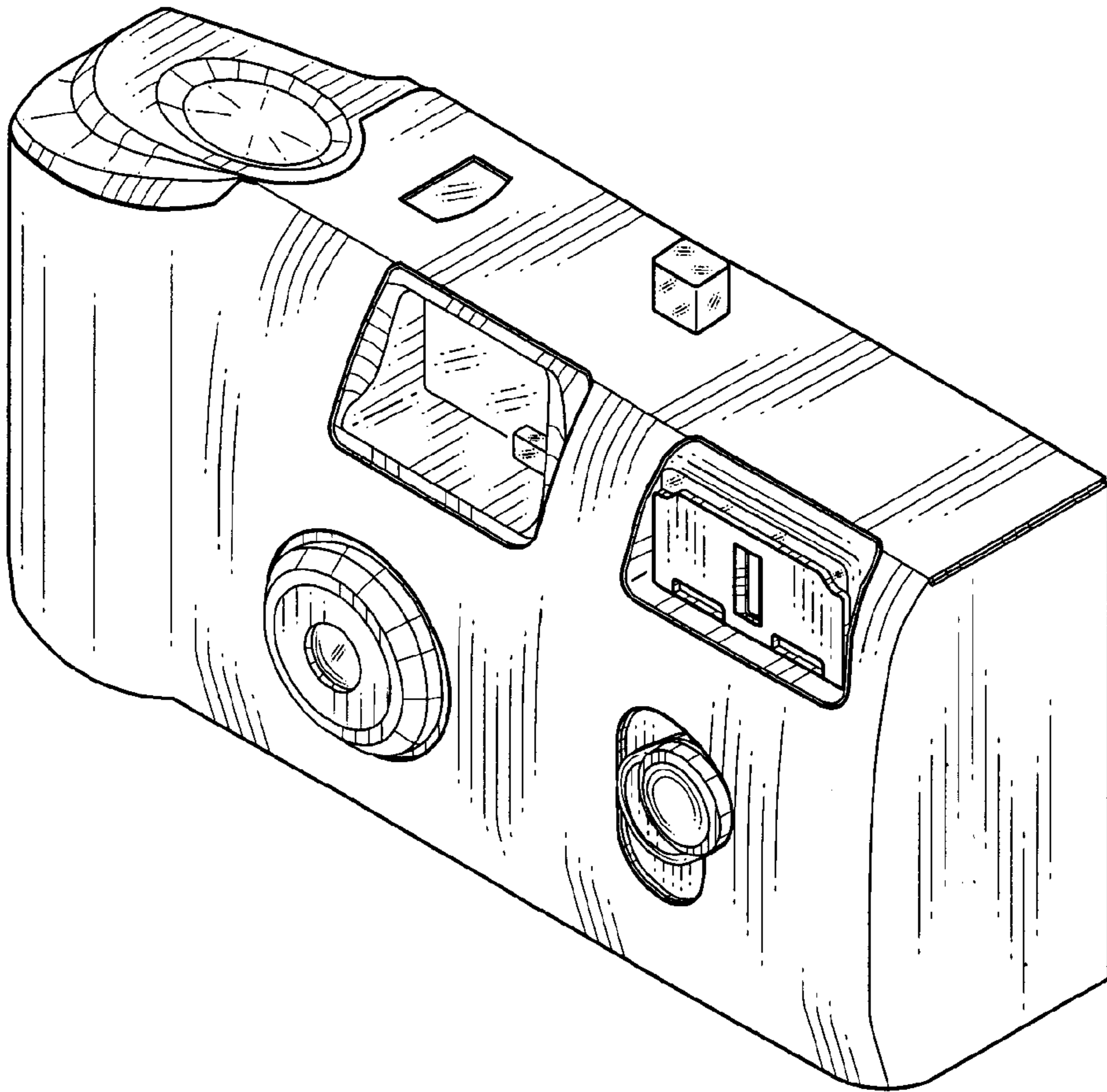

FIG. 2

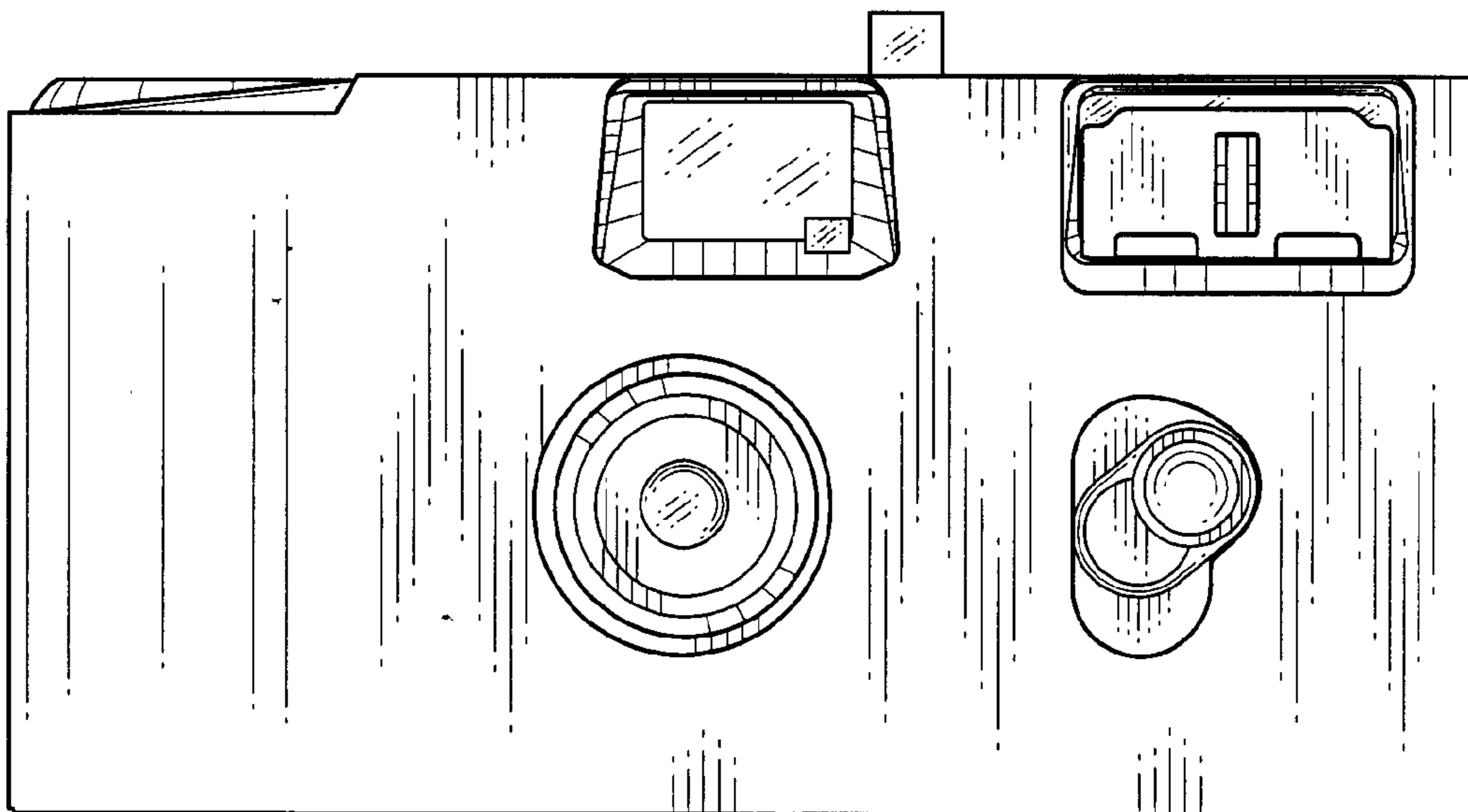

FIG.3

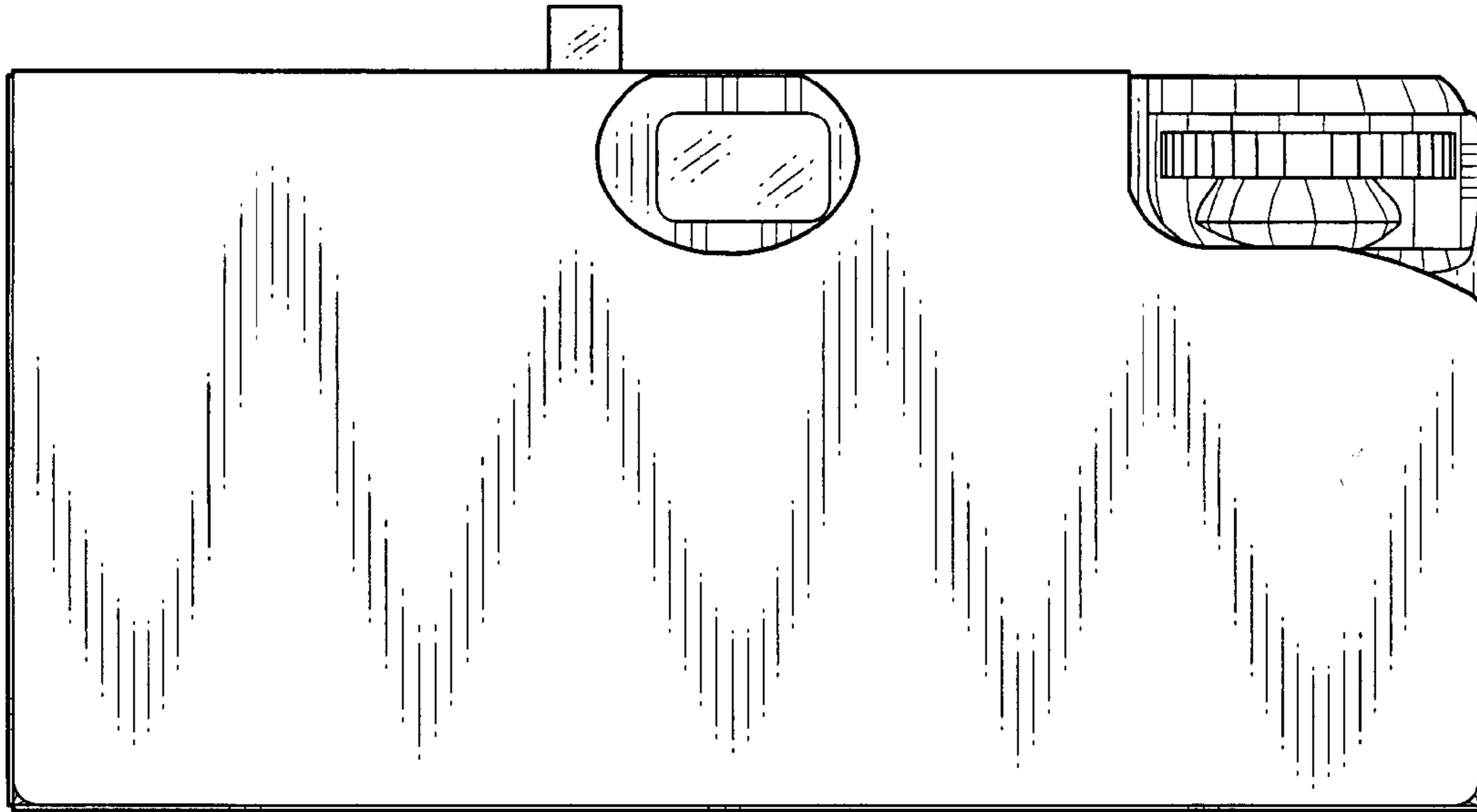

FIG.4

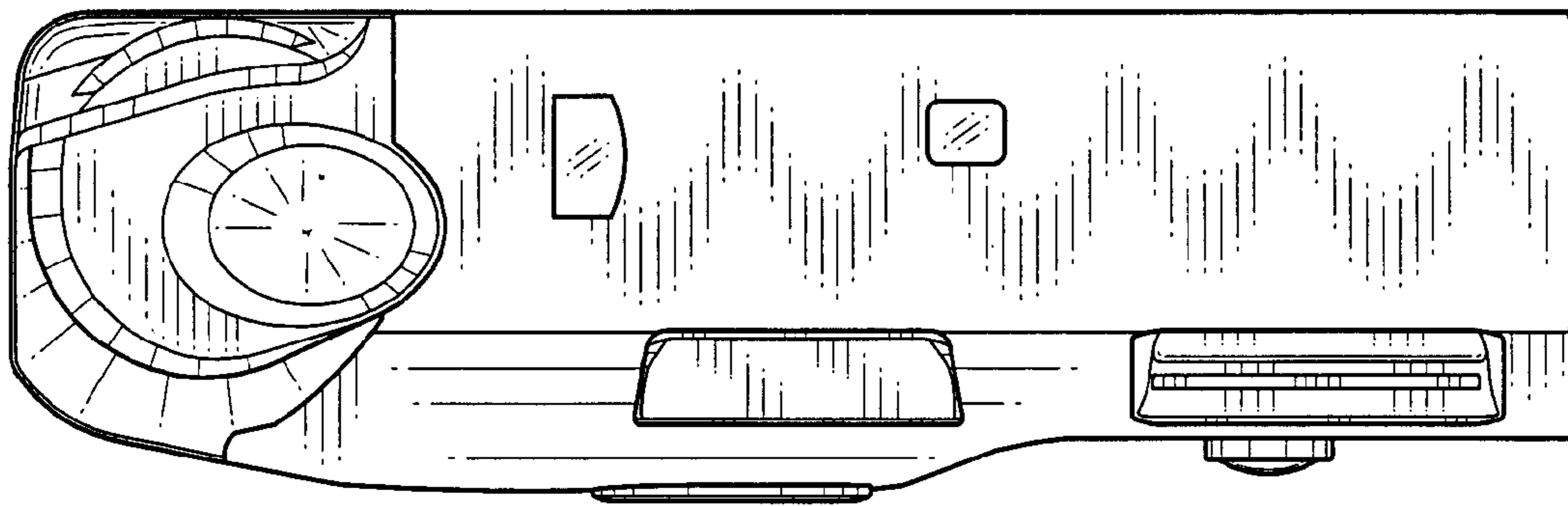

FIG. 5

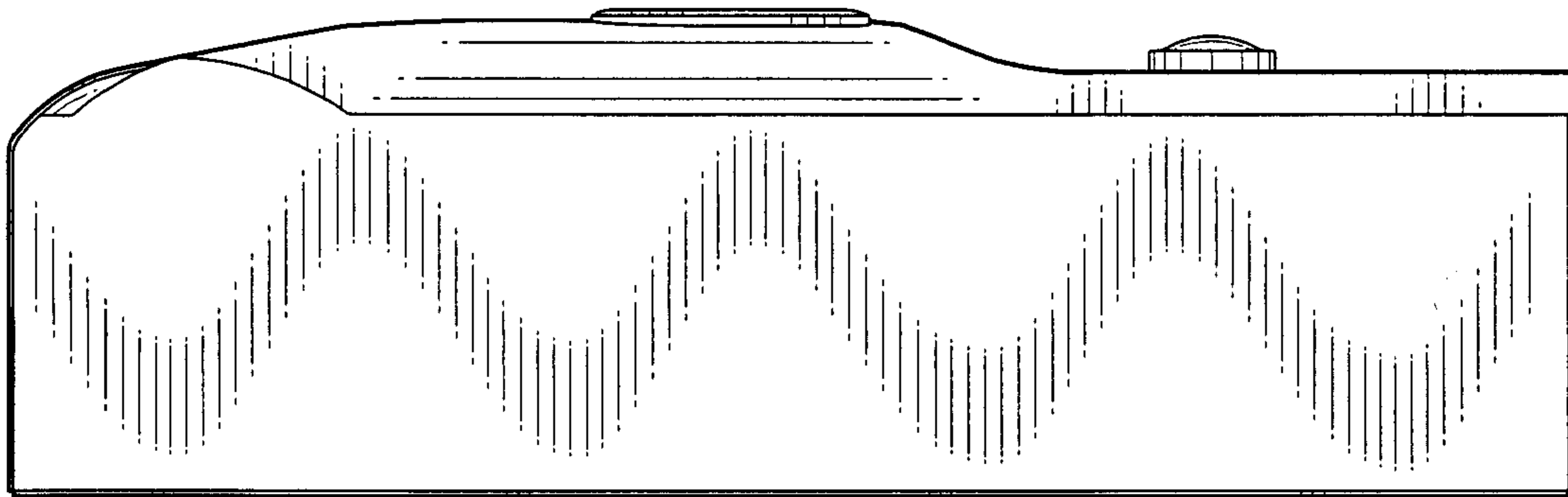

FIG. 6

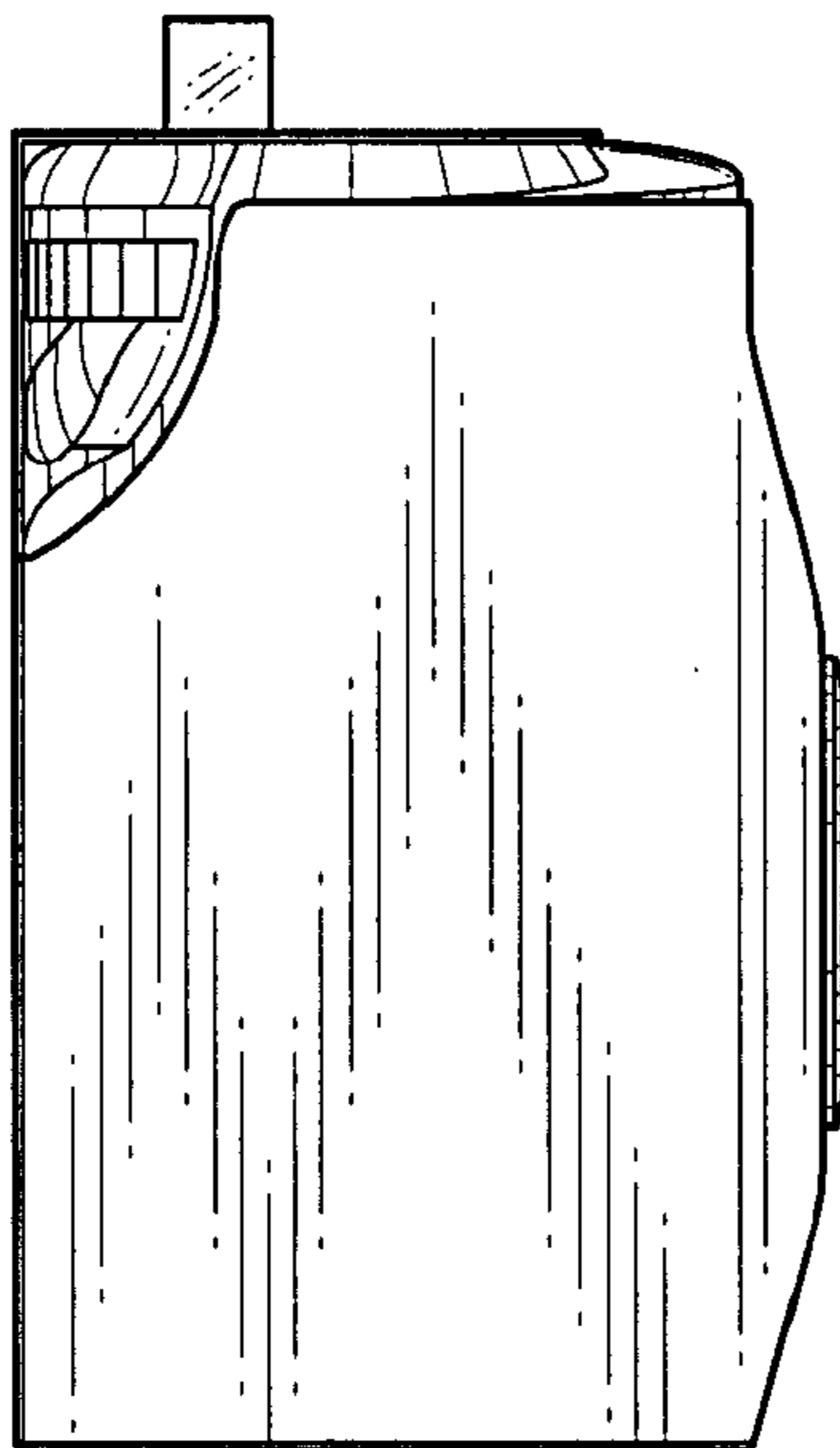

FIG. 7

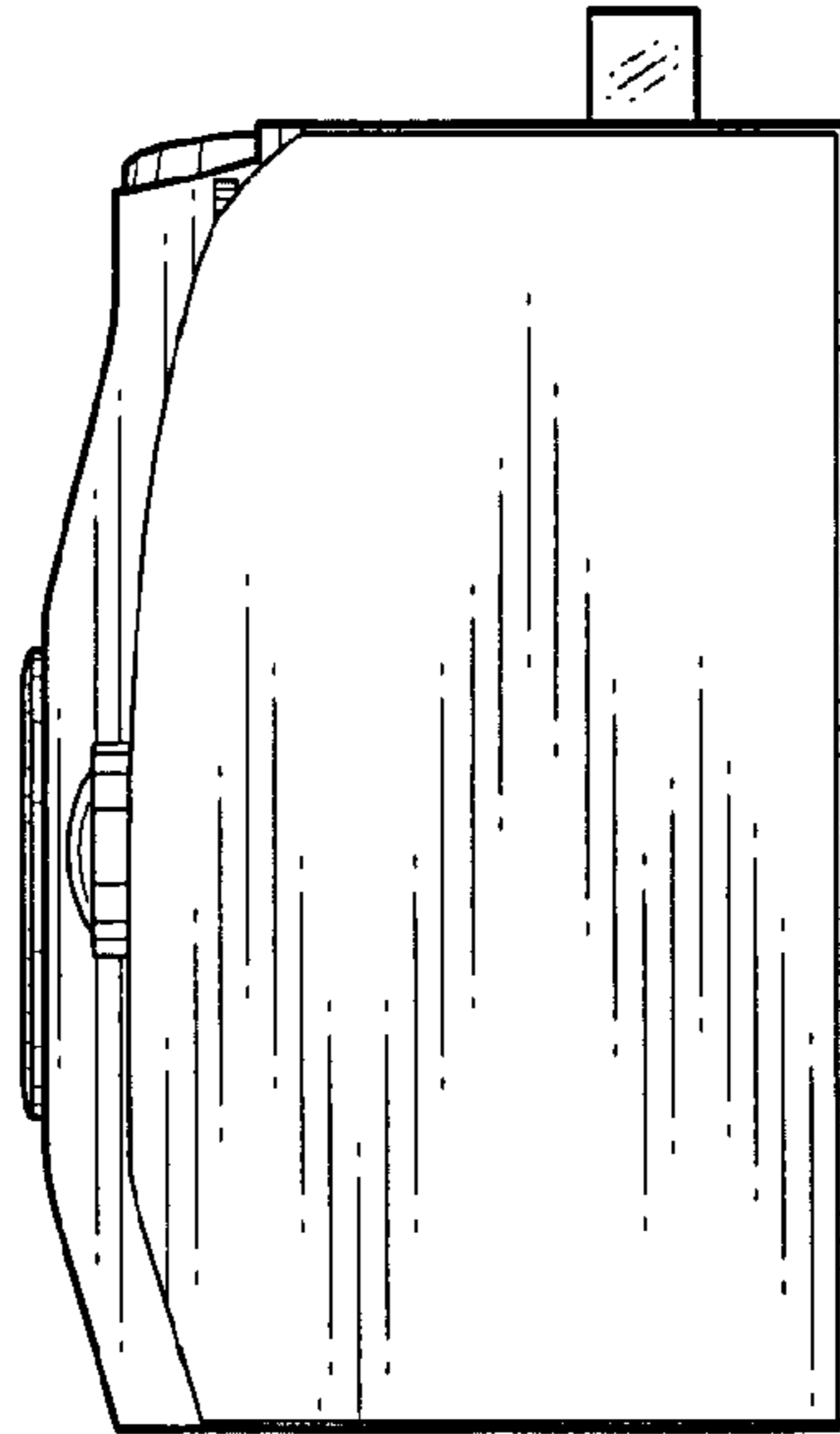

FIG. 8

