

US00D547347S

(12) **United States Design Patent**
Kim

(10) **Patent No.:** **US D547,347 S**

(45) **Date of Patent:** **** Jul. 24, 2007**

(54) **MONITORING CAMERA**

D491,968 S * 6/2004 Isshiki D16/203

(75) Inventor: **Min-Geun Kim**, Seoul (KR)

OTHER PUBLICATIONS

(73) Assignee: **Samsung Electronics Co., Ltd.**,
Kyunggi-do (KR)

U.S. Appl. No. 29/251,372, Applicant: Min-Geun Kim, filed Jan. 6, 2006 entitled Monitoring Camera.

U.S. Appl. No. 29/226,441, Applicant: Min-Geun Kim, et al., filed Mar. 29, 2005 entitled Monitoring Camera.

(**) Term: **14 Years**

* cited by examiner

(21) Appl. No.: **29/251,373**

Primary Examiner—Ian Simmons

Assistant Examiner—Wan Laymon

(22) Filed: **Jan. 6, 2006**

(74) *Attorney, Agent, or Firm*—Flynn, Thiel, Boutell & Tanis, P.C.

(51) **LOC (8) Cl.** **16-01**

(52) **U.S. Cl.** **D16/203; D16/202**

(58) **Field of Classification Search** D16/200–206,
D16/208–209, 217, 219, 242, 244, 245, 214,
D16/218, 213; D21/514; 248/373–376;
358/906, 909.1; 396/535–541, 427; 348/143;
352/242

See application file for complete search history.

(57) **CLAIM**

The ornamental design for a monitoring camera, as shown and described.

(56) **References Cited**

U.S. PATENT DOCUMENTS

- D388,450 S * 12/1997 Hamano et al. D16/203
- D402,677 S * 12/1998 Hiraguchi D16/203
- D412,924 S * 8/1999 Hiraguchi D16/219
- D415,509 S * 10/1999 Hiraguchi D16/203
- D449,630 S * 10/2001 Rak et al. D16/203
- D450,075 S * 11/2001 Uehara D16/203
- 6,357,936 B1 * 3/2002 Elberbaum 396/427

DESCRIPTION

FIG. 1 is a top front perspective view of a monitoring camera showing our new design;

FIG. 2 is a front elevational view thereof;

FIG. 3 is a rear elevational view thereof;

FIG. 4 is a left side elevational view, the right side view being symmetrical thereof;

FIG. 5 is a top plan view thereof; and,

FIG. 6 is a bottom plan view.

1 Claim, 4 Drawing Sheets

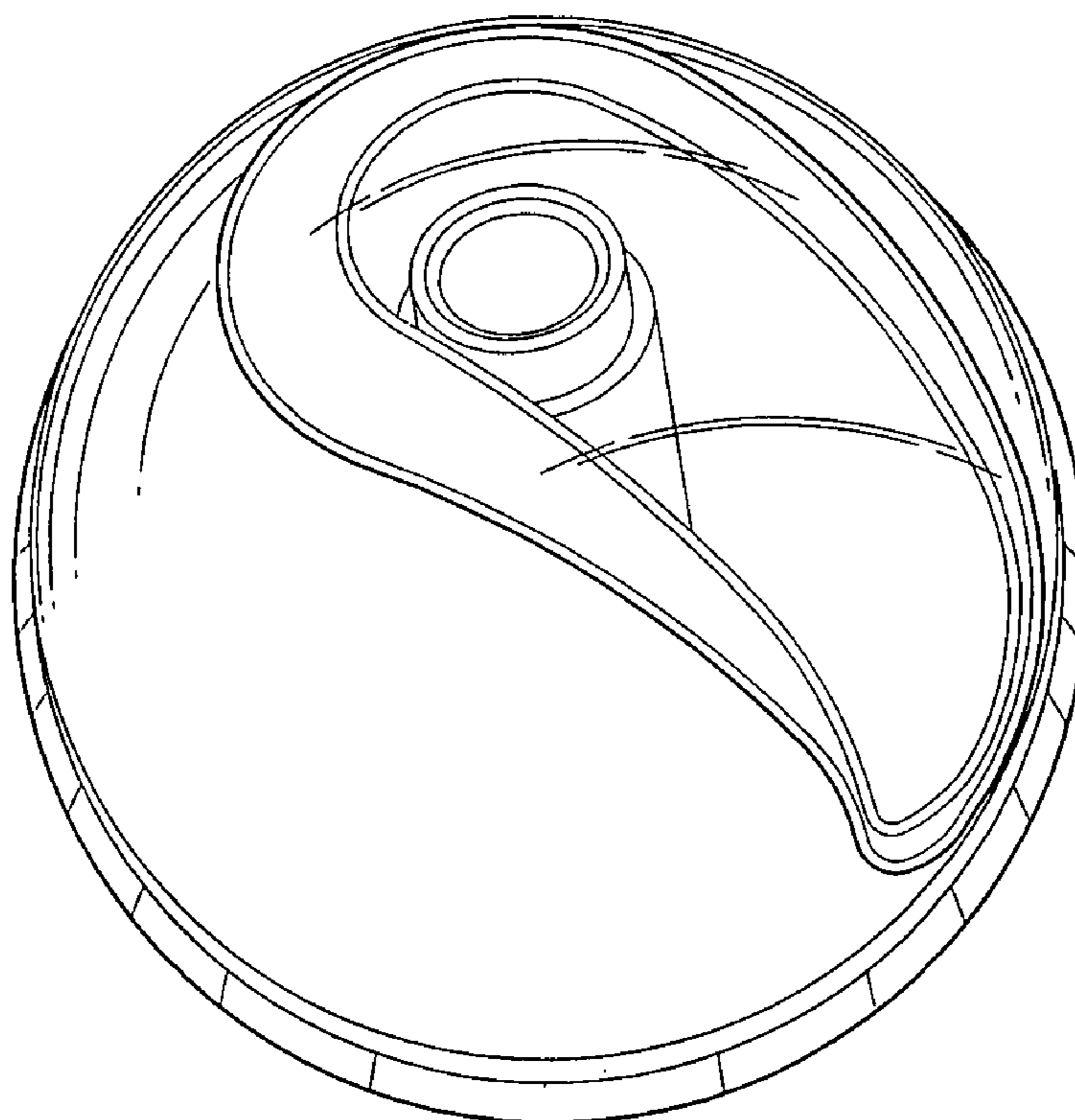

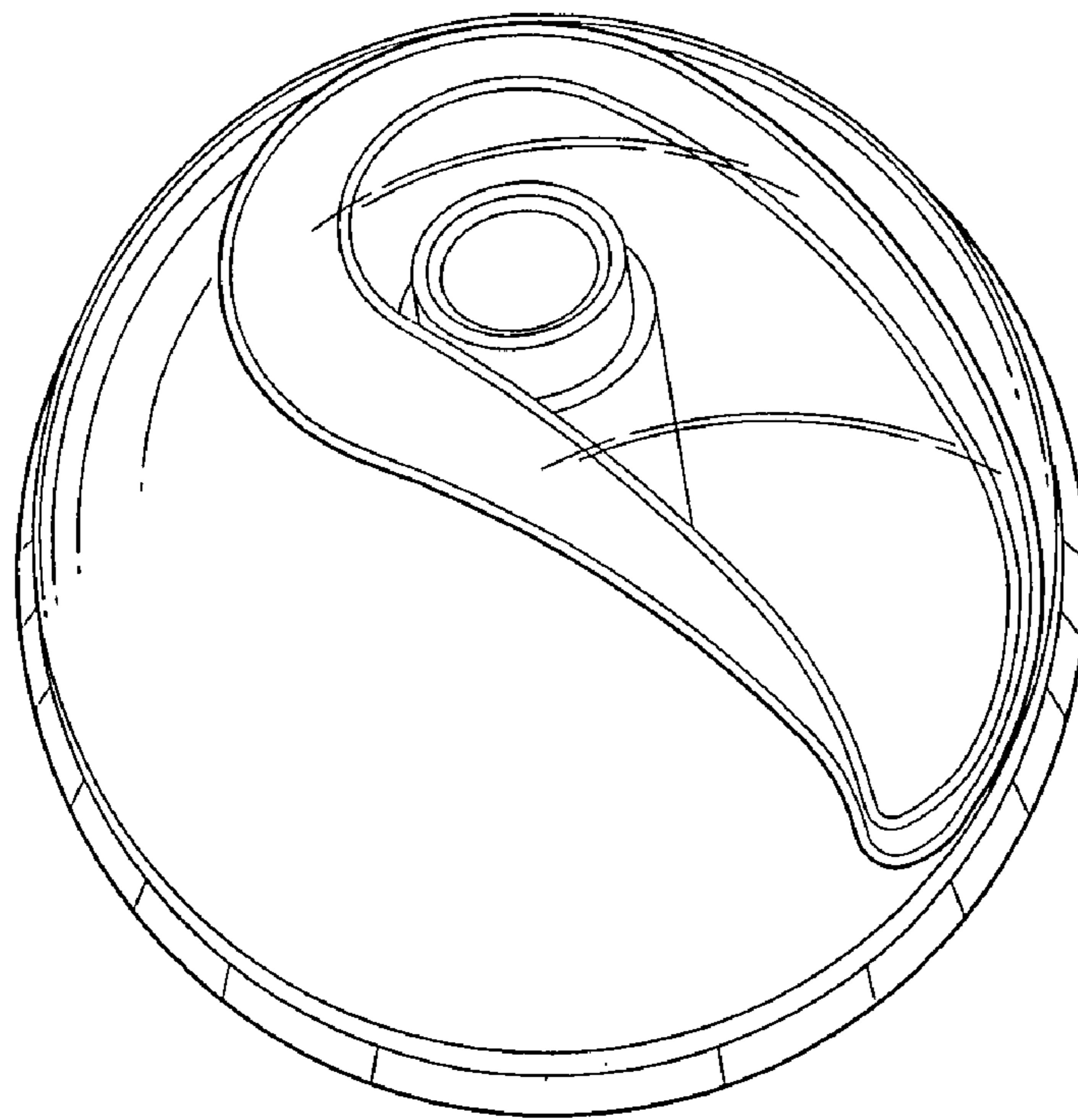

FIG. 1

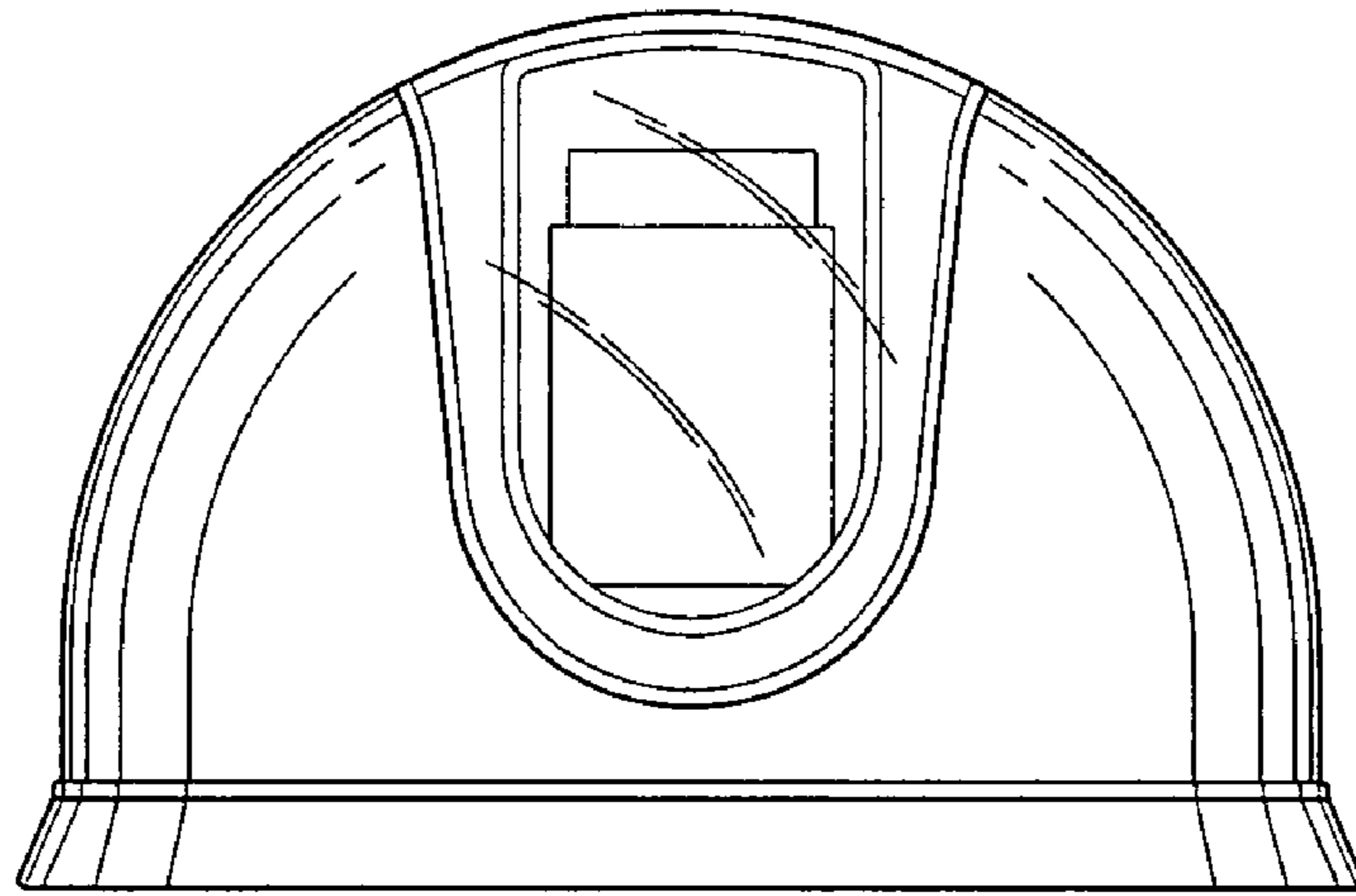

FIG. 2

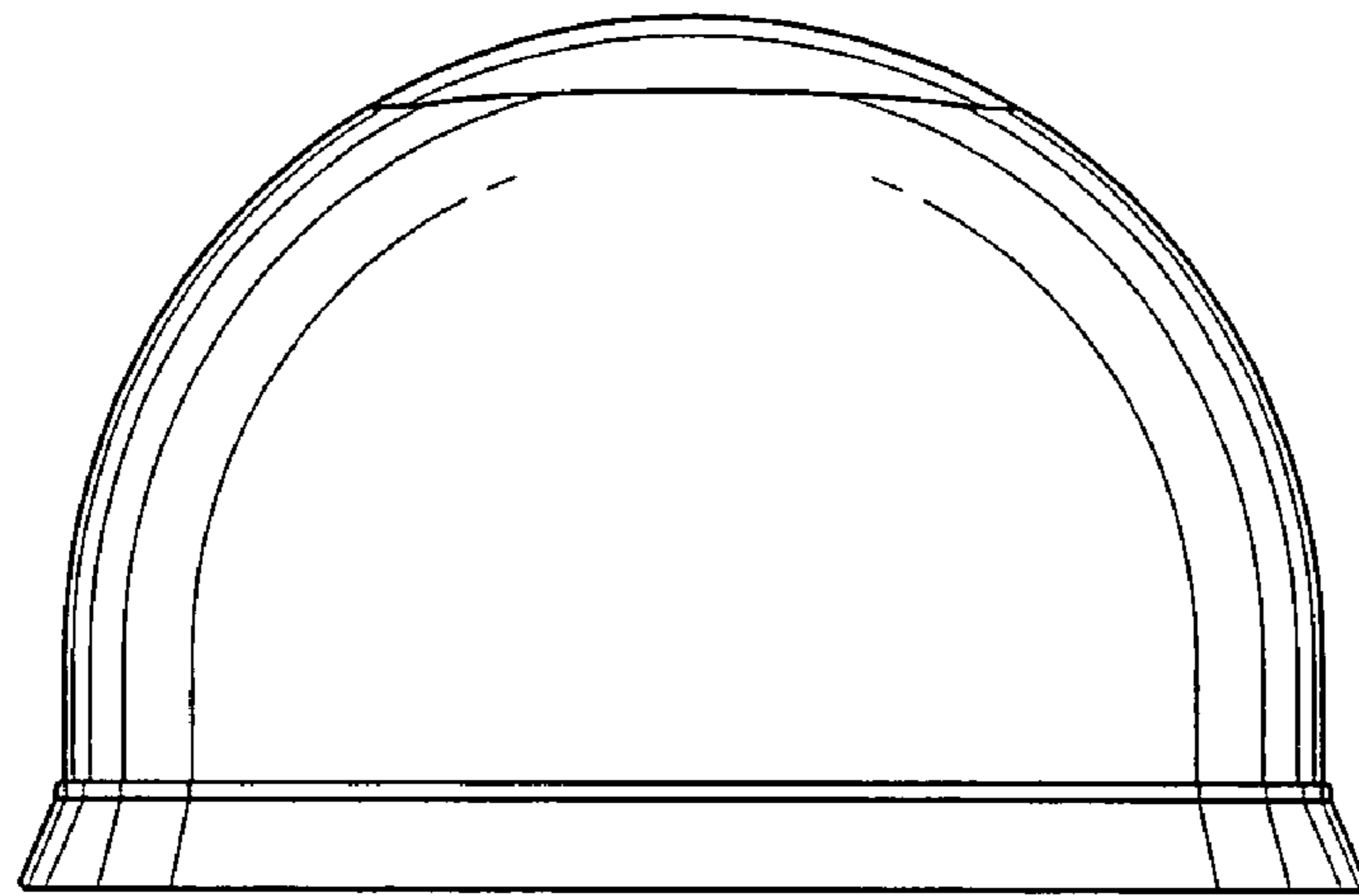

FIG. 3

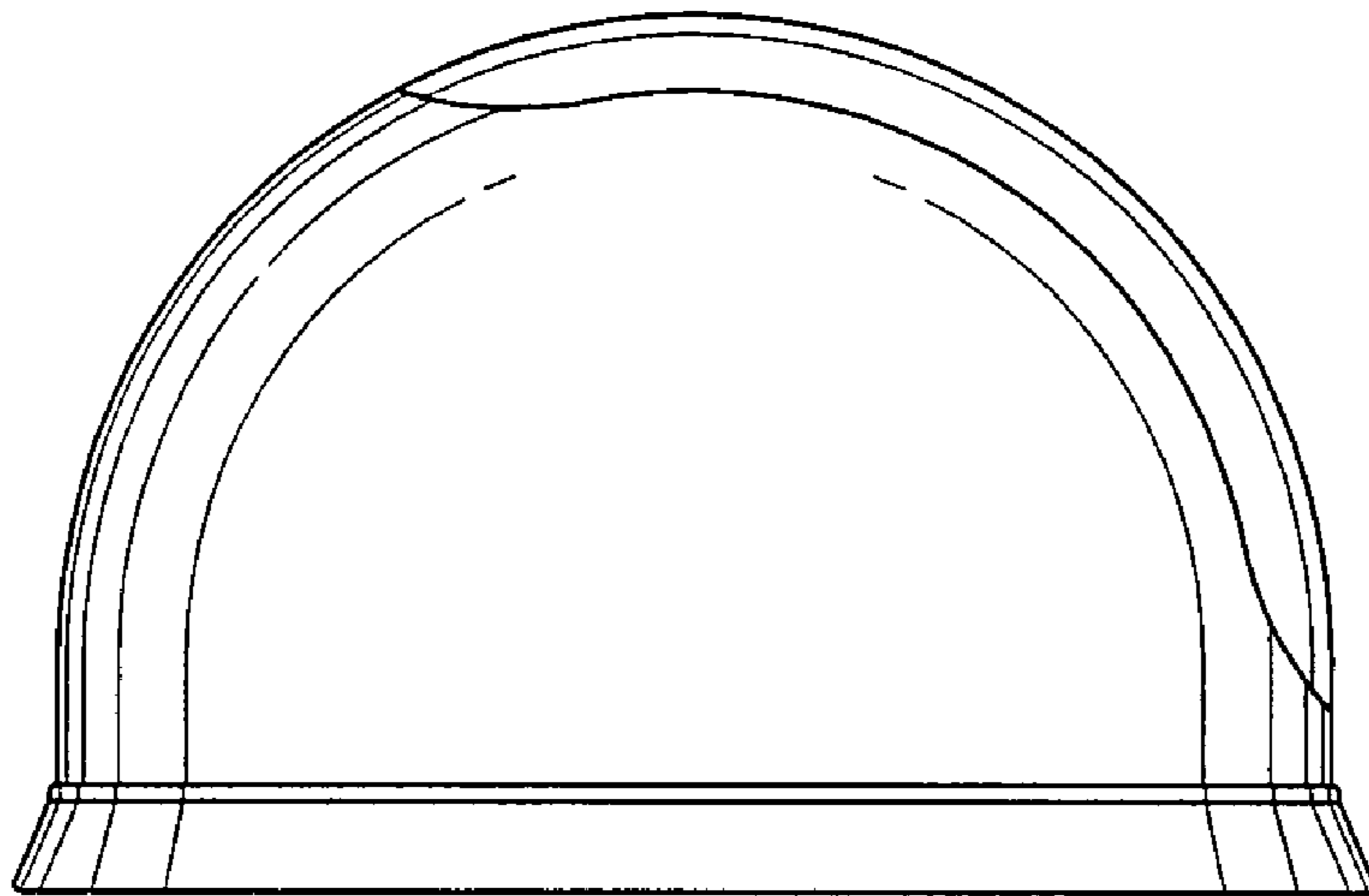

FIG. 4

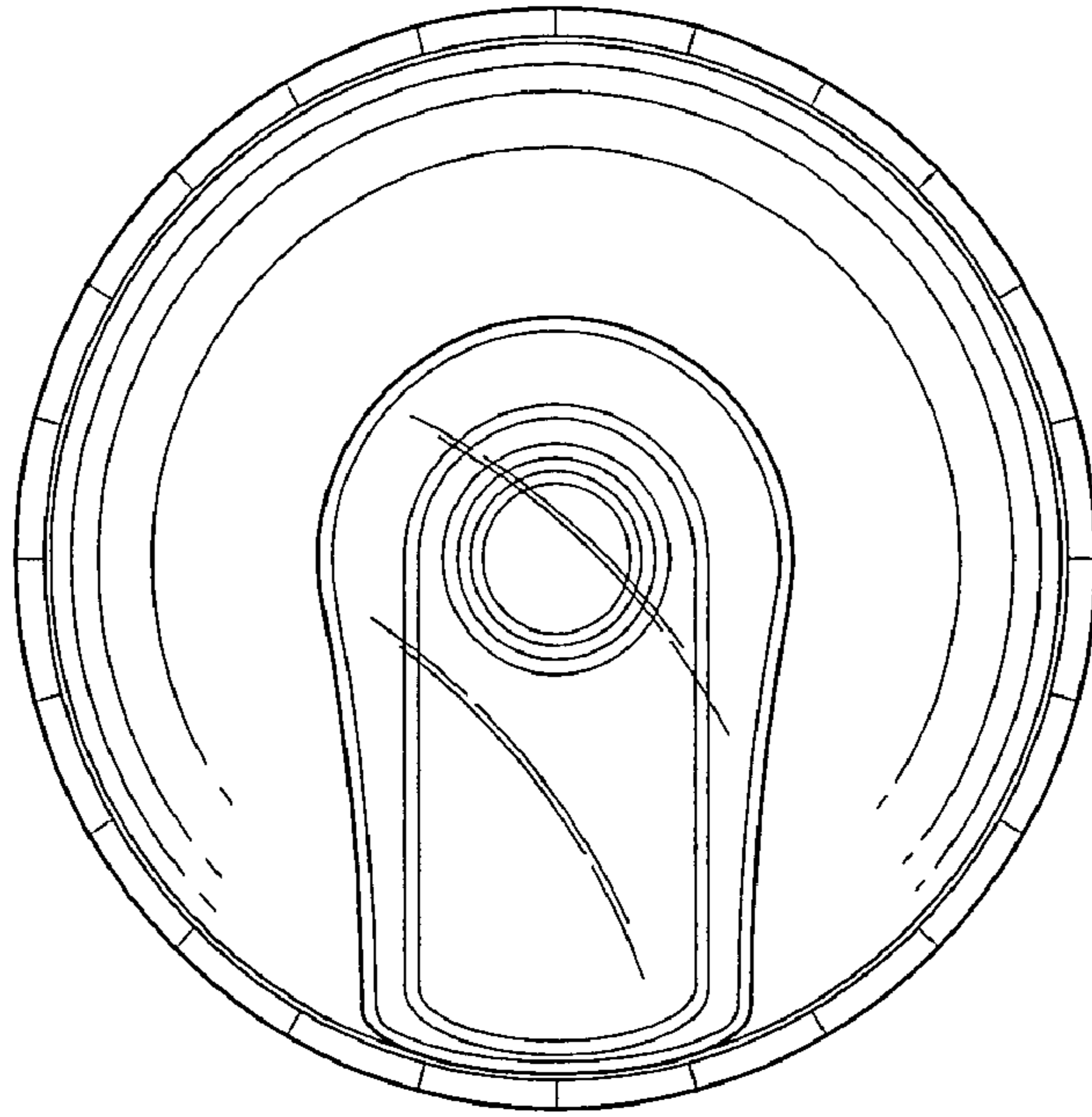

FIG. 5

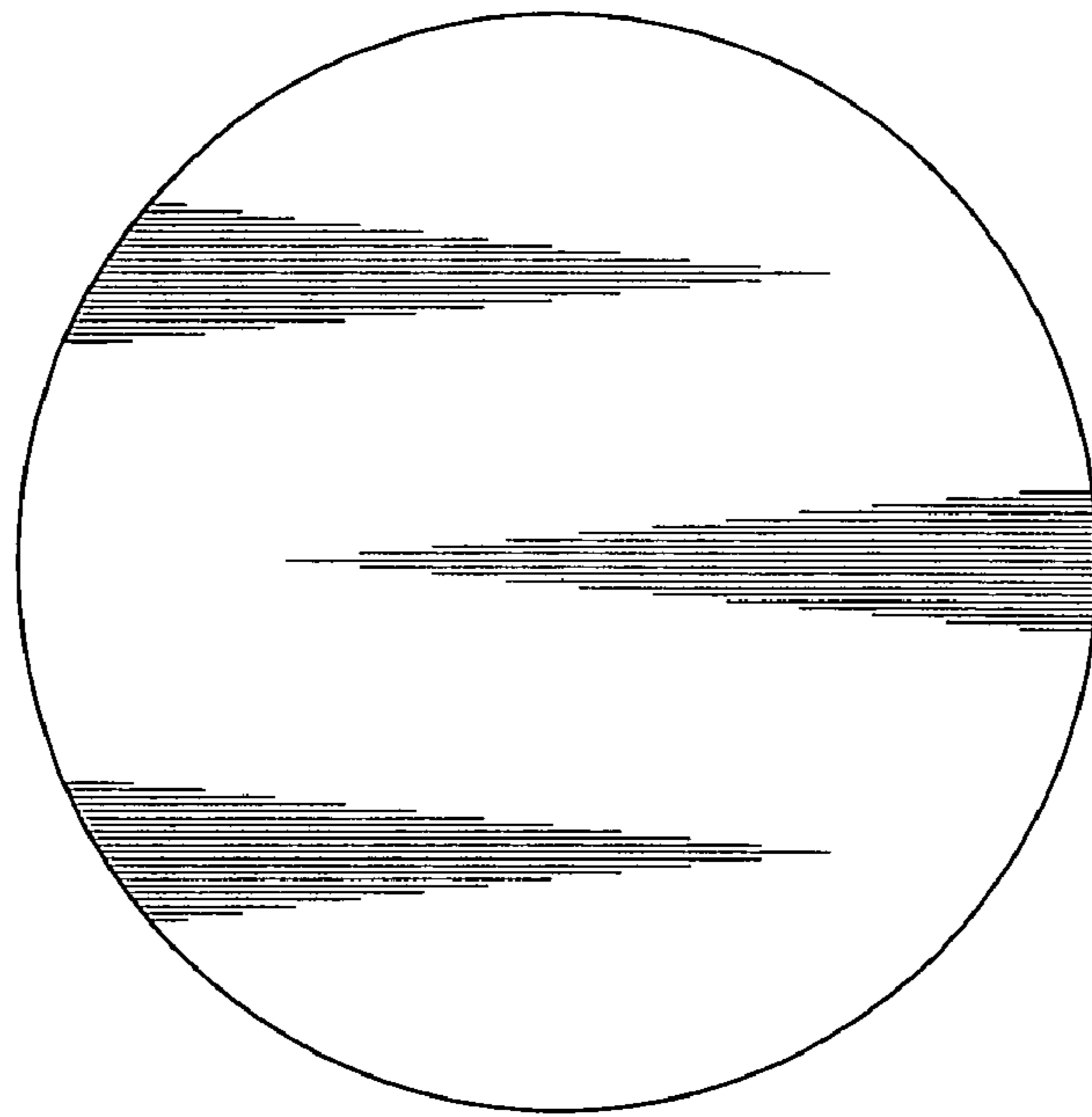

FIG. 6