



US00D547314S

(12) **United States Design Patent**
Wu

(10) **Patent No.:** **US D547,314 S**

(45) **Date of Patent:** **** Jul. 24, 2007**

(54) **FACE PLATE FOR COMPUTER HOUSING**

(75) Inventor: **Chen-Her Wu**, Taipei (TW)

(73) Assignee: **Shuttle Inc**, Taipei (TW)

(**) Term: **14 Years**

(21) Appl. No.: **29/255,748**

(22) Filed: **Mar. 10, 2006**

(51) **LOC (8) Cl.** **14-02**

(52) **U.S. Cl.** **D14/441**

(58) **Field of Classification Search** D14/441-446,
D14/432; D13/162, 184, 199; 312/223.2;
361/680-686, 690-696; 369/34.01, 36.01
See application file for complete search history.

(56) **References Cited**

U.S. PATENT DOCUMENTS

D360,411 S *	7/1995	Sharp et al.	D14/445
D485,842 S *	1/2004	Dearborn et al.	D14/432
D502,707 S *	3/2005	Huang-Yao	D14/441
D504,435 S *	4/2005	Hsu	D14/441
D504,436 S *	4/2005	Chen et al.	D14/441

* cited by examiner

Primary Examiner—Freda S. Nunn

(74) *Attorney, Agent, or Firm*—Birch, Stewart, Kolasch & Birch, LLP

(57) **CLAIM**

The ornamental design for a face plate for computer housing, as shown and described.

DESCRIPTION

FIG. 1 is a perspective view of a face plate for computer housing showing my new design;

FIG. 2 is a front view thereof;

FIG. 3 is a rear view thereof;

FIG. 4 is a left side view thereof;

FIG. 5 is a right side view thereof;

FIG. 6 is a top view thereof;

FIG. 7 is a bottom view thereof; and,

FIG. 8 is a perspective view showing the face plate for computer housing in use.

The broken line environmental showing is for illustrative purpose only and forms no part of the claimed design.

1 Claim, 6 Drawing Sheets

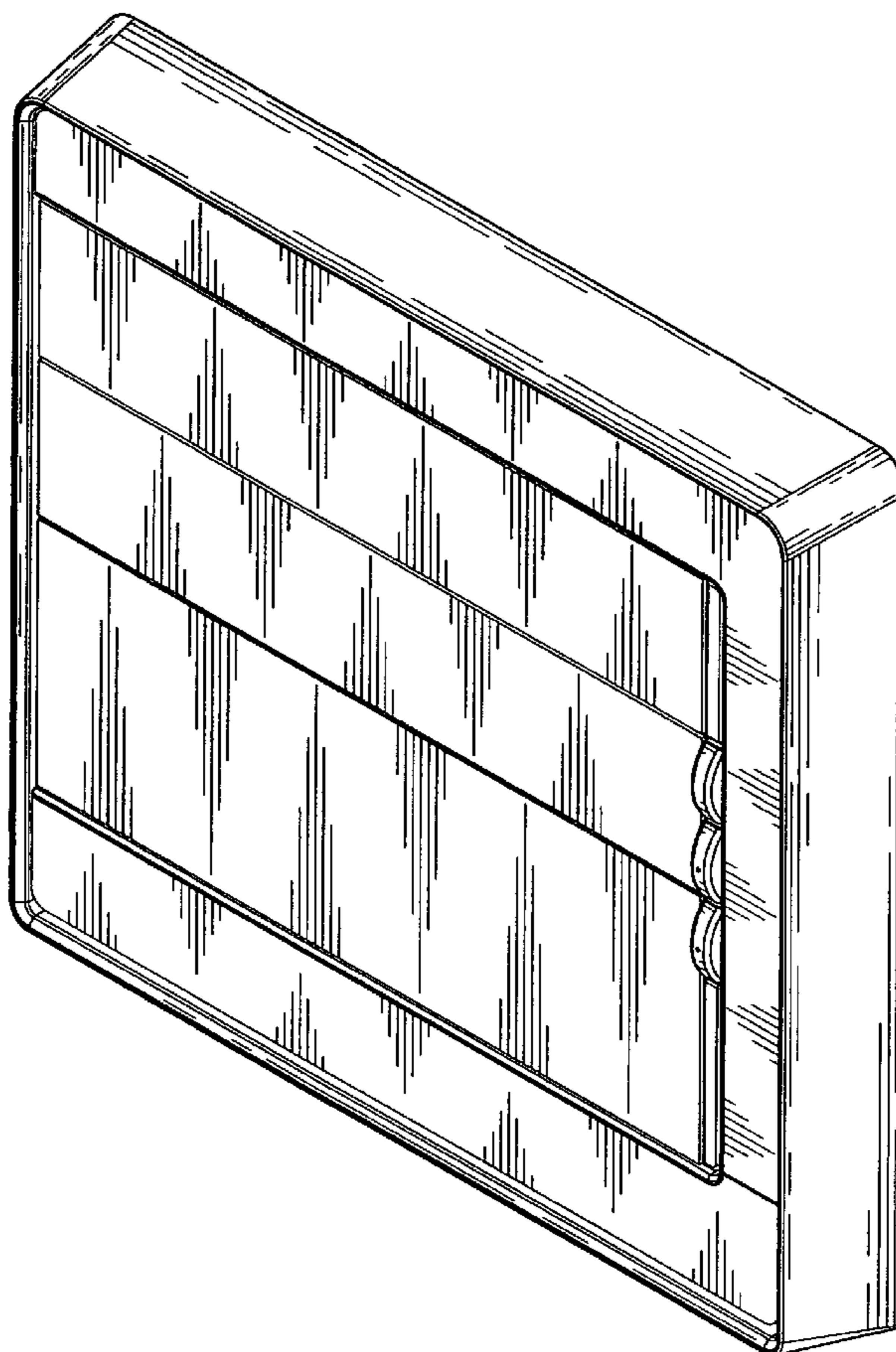

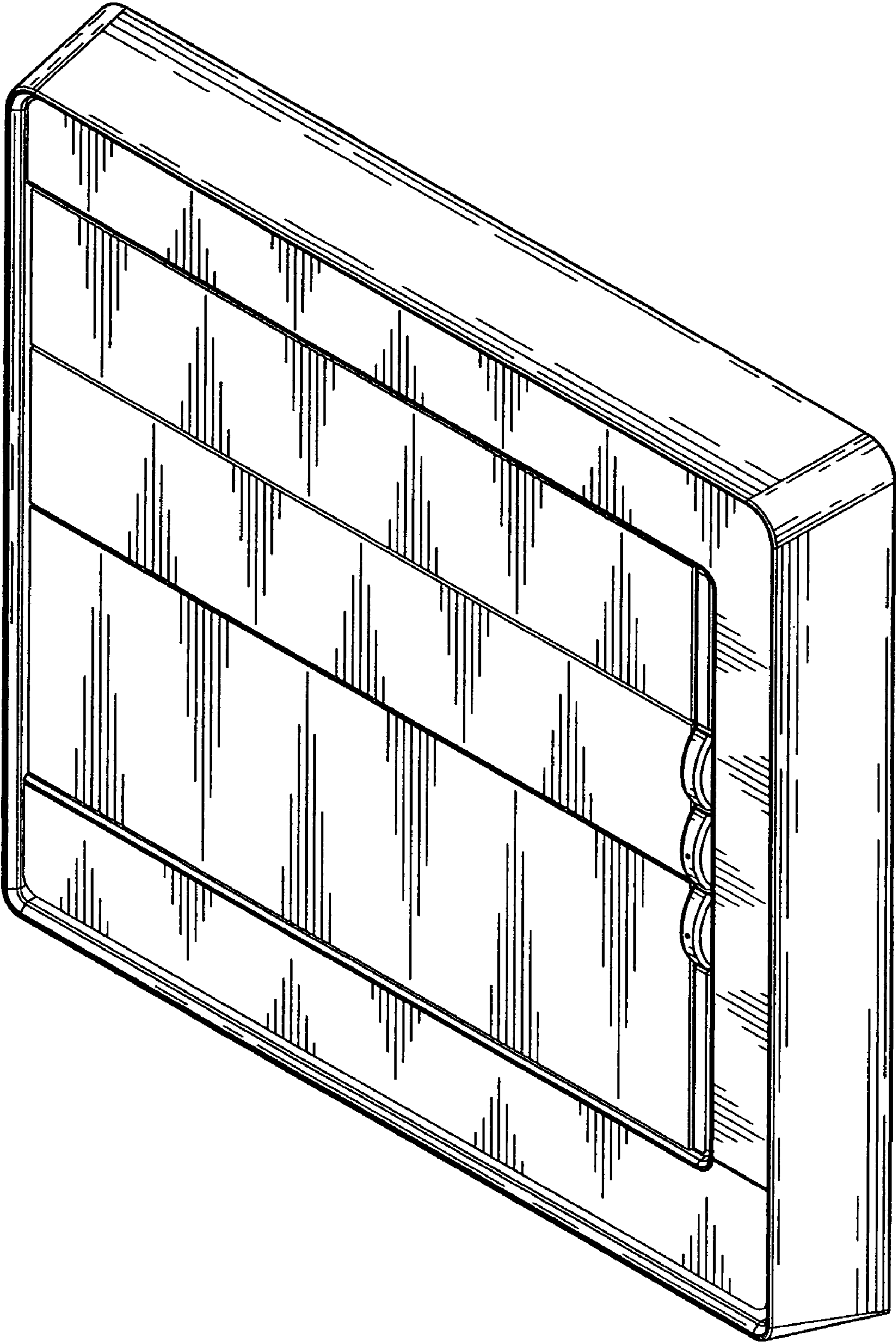

FIG.1

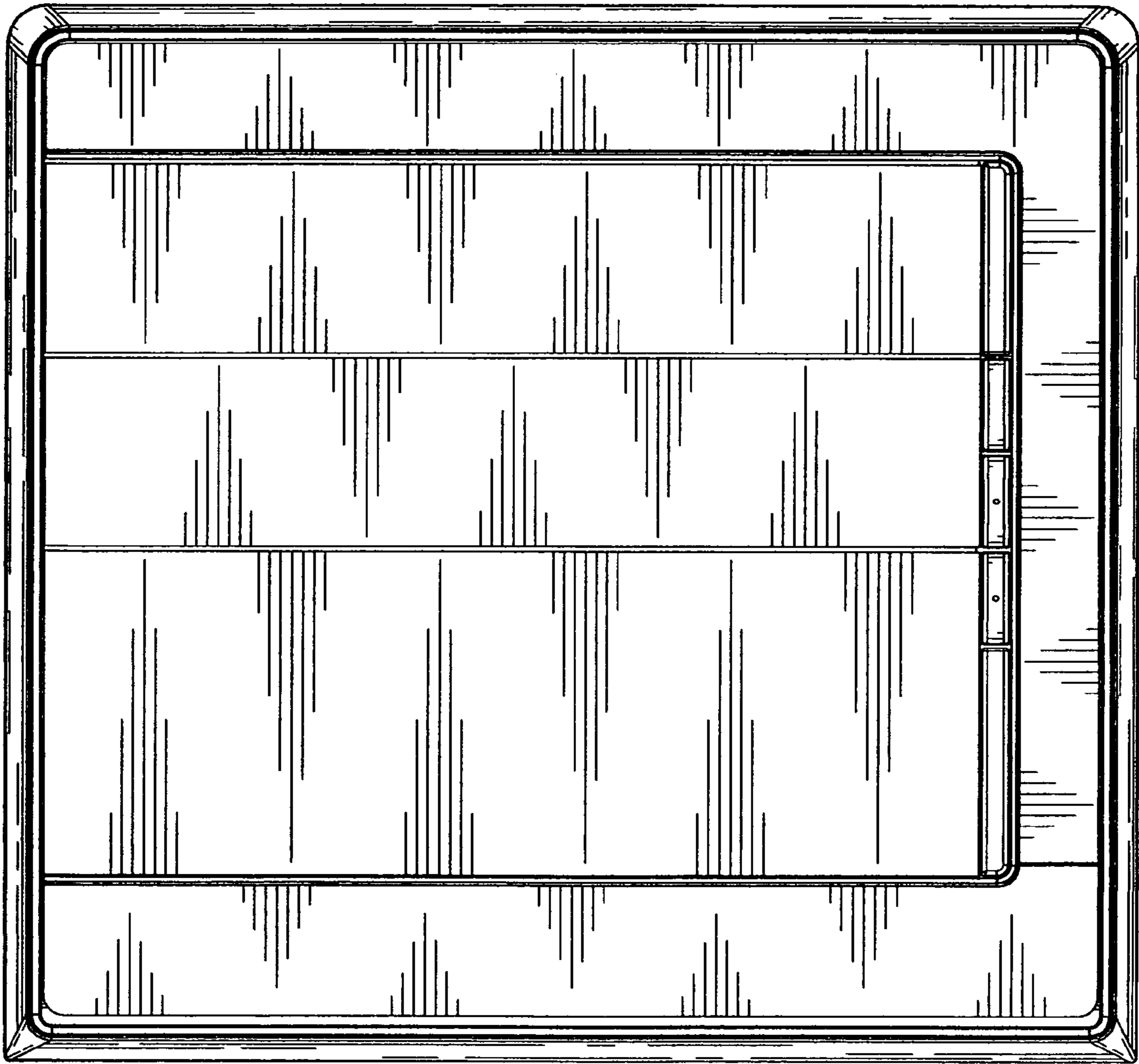

FIG.2

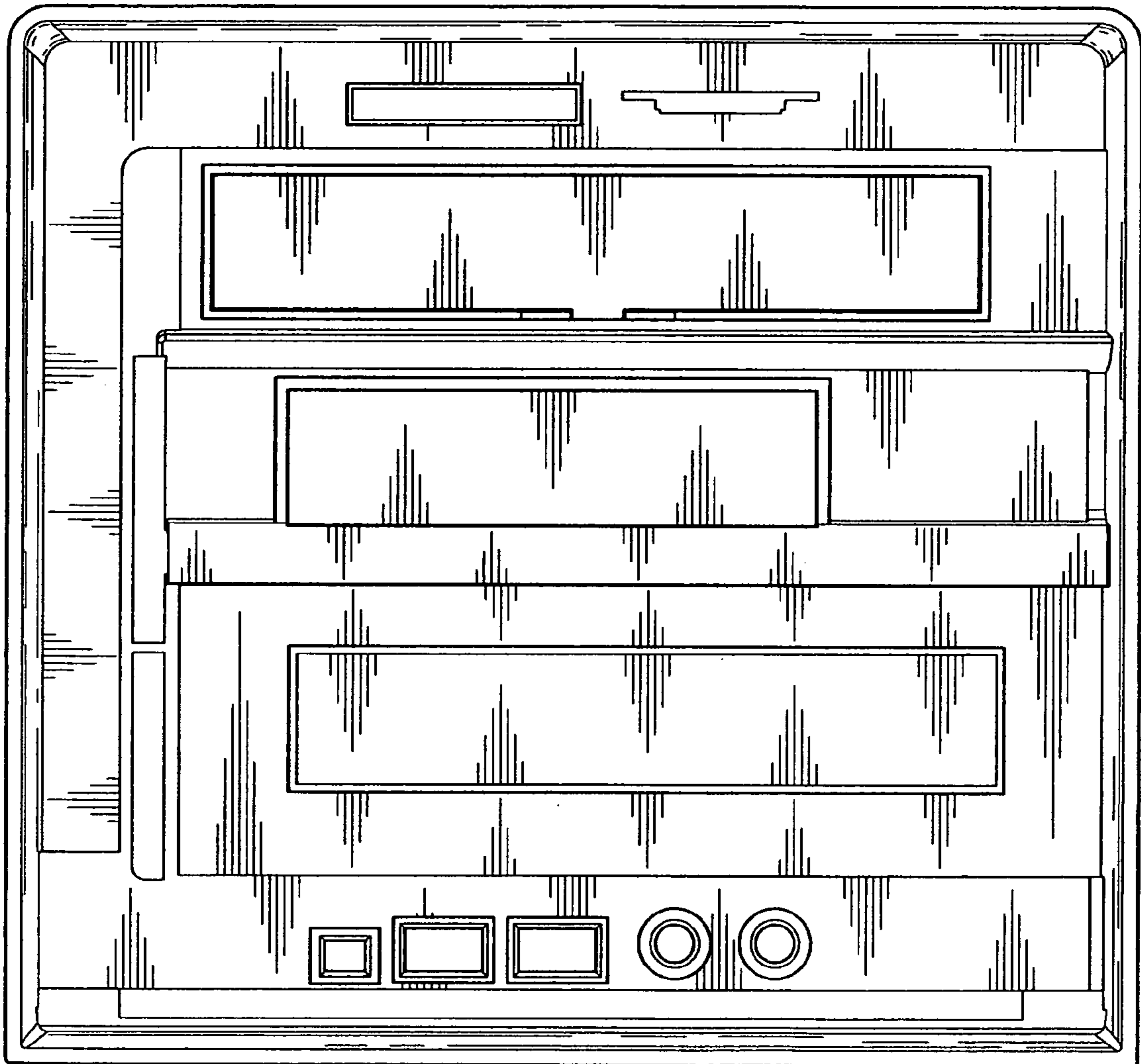

FIG.3

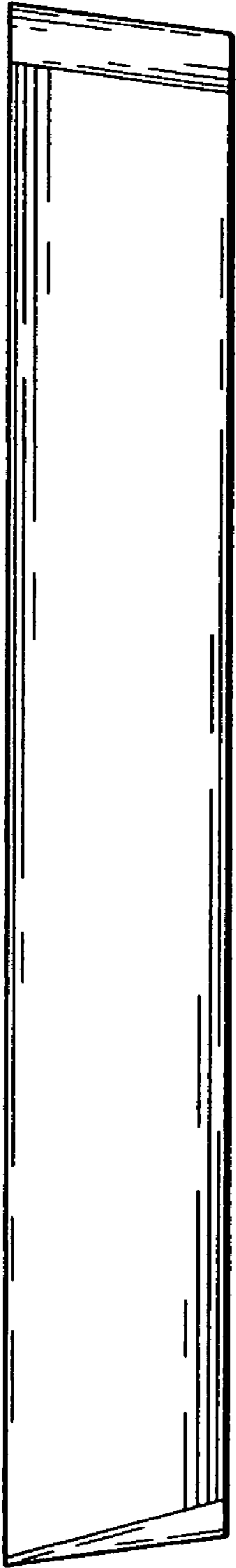

FIG. 4

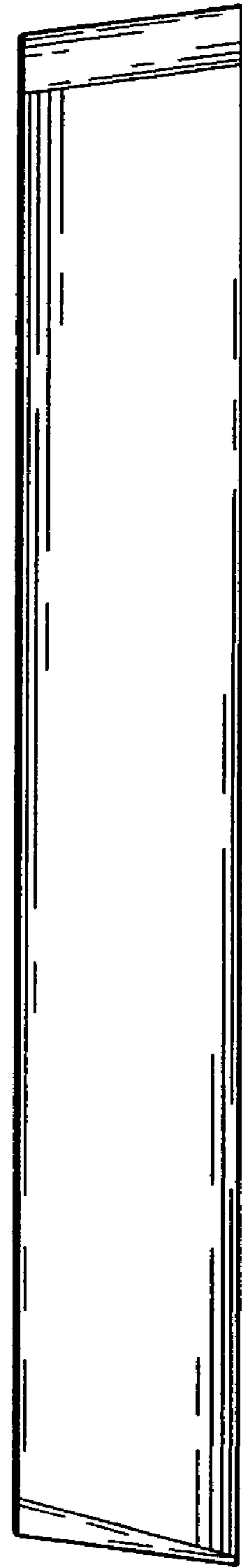

FIG. 5

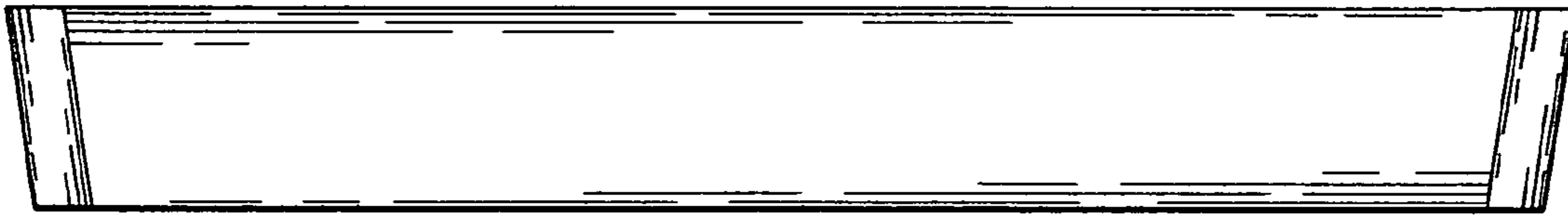

FIG. 6

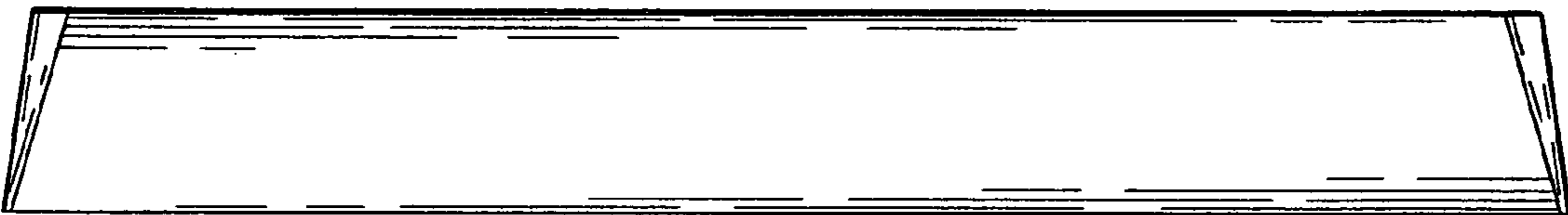

FIG. 7

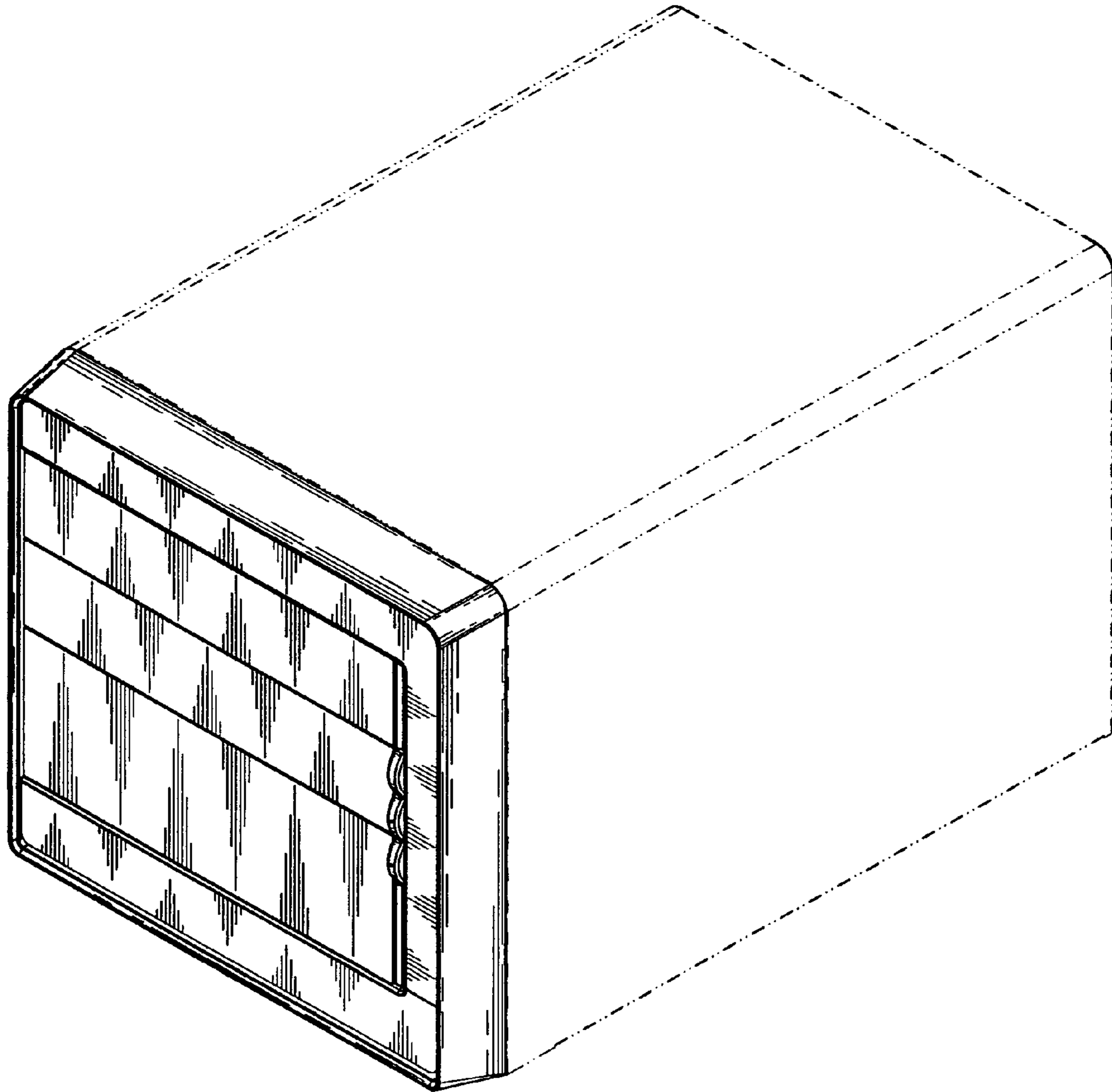

FIG.8