



US00D547224S

(12) **United States Design Patent**  
**Cramer**

(10) **Patent No.:** **US D547,224 S**

(45) **Date of Patent:** **\*\* Jul. 24, 2007**

(54) **TIMEPIECE FACE**

(76) **Inventor:** **Steven Cramer**, 21-48 45th Ave., Long Island City, NY (US) 11101

(\*\*) **Term:** **14 Years**

(21) **Appl. No.:** **29/215,443**

(22) **Filed:** **Oct. 18, 2004**

(51) **LOC (8) Cl.** ..... **10-07**

(52) **U.S. Cl.** ..... **D10/126**

(58) **Field of Classification Search** ..... D10/1-27,  
D10/43, 123, 126; 368/276, 316, 317, 228,  
368/232, 239-242, 10, 179, 180-183; D18/10;  
235/77, 78 R-78 RC, 83

See application file for complete search history.

(56) **References Cited**

**U.S. PATENT DOCUMENTS**

D257,963 S *	1/1981	Sticker	.....	D10/126
D270,844 S *	10/1983	McIntyre	.....	D19/64
D279,111 S *	6/1985	Wilkinson	.....	D18/10
D279,457 S *	7/1985	Murphy	.....	D10/22
4,568,822 A *	2/1986	Betzko	.....	235/78 R
D348,399 S *	7/1994	Chen	.....	D10/22
D401,526 S *	11/1998	Stunder	.....	D10/126
D484,422 S *	12/2003	Hnidak	.....	D10/21

\* cited by examiner

*Primary Examiner*—Robert M. Spear  
*Assistant Examiner*—George D. Kirschbaum, Jr.  
(74) *Attorney, Agent, or Firm*—Epstein Drangel Bazerman & James; Robert L. Epstein

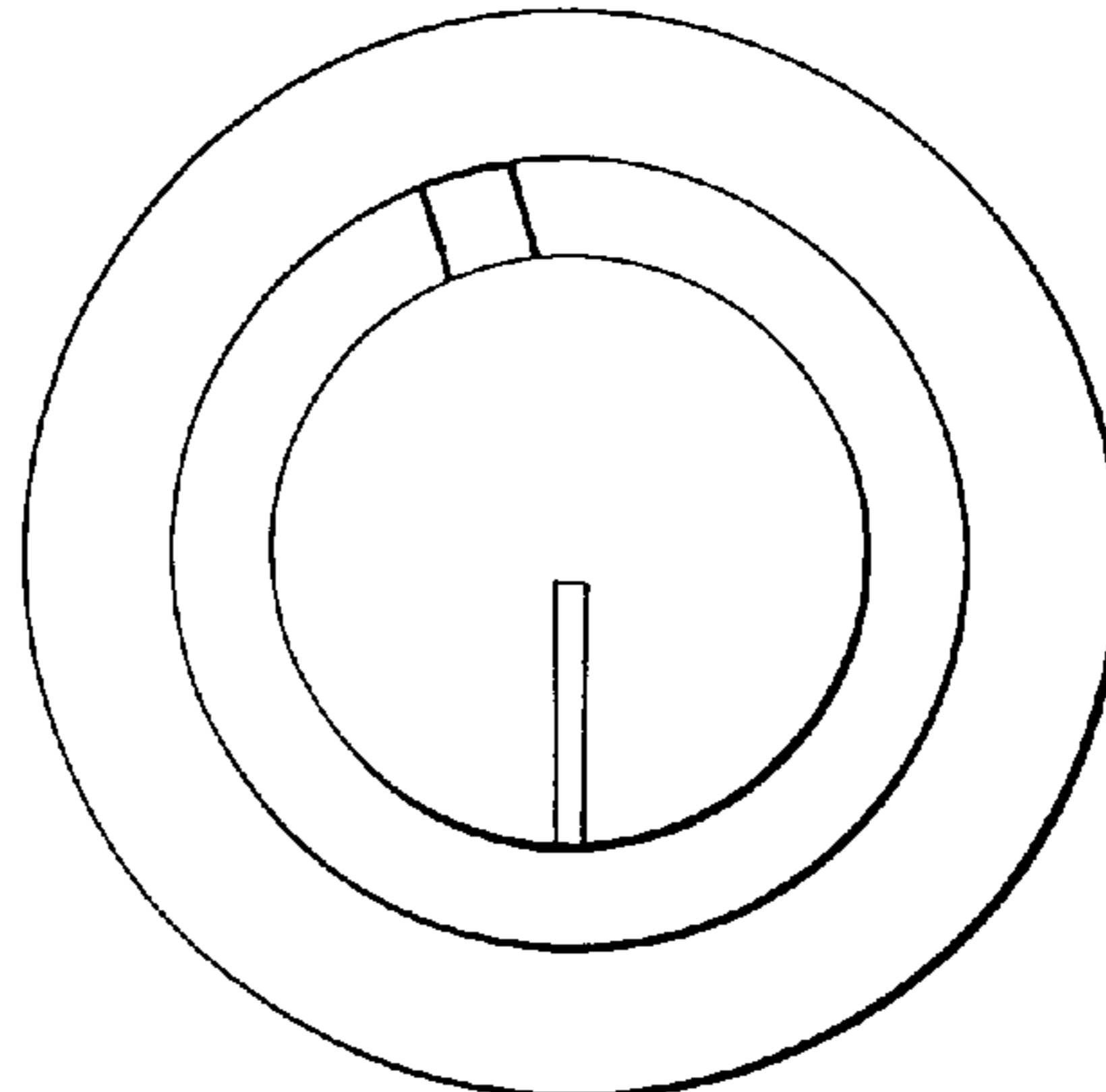
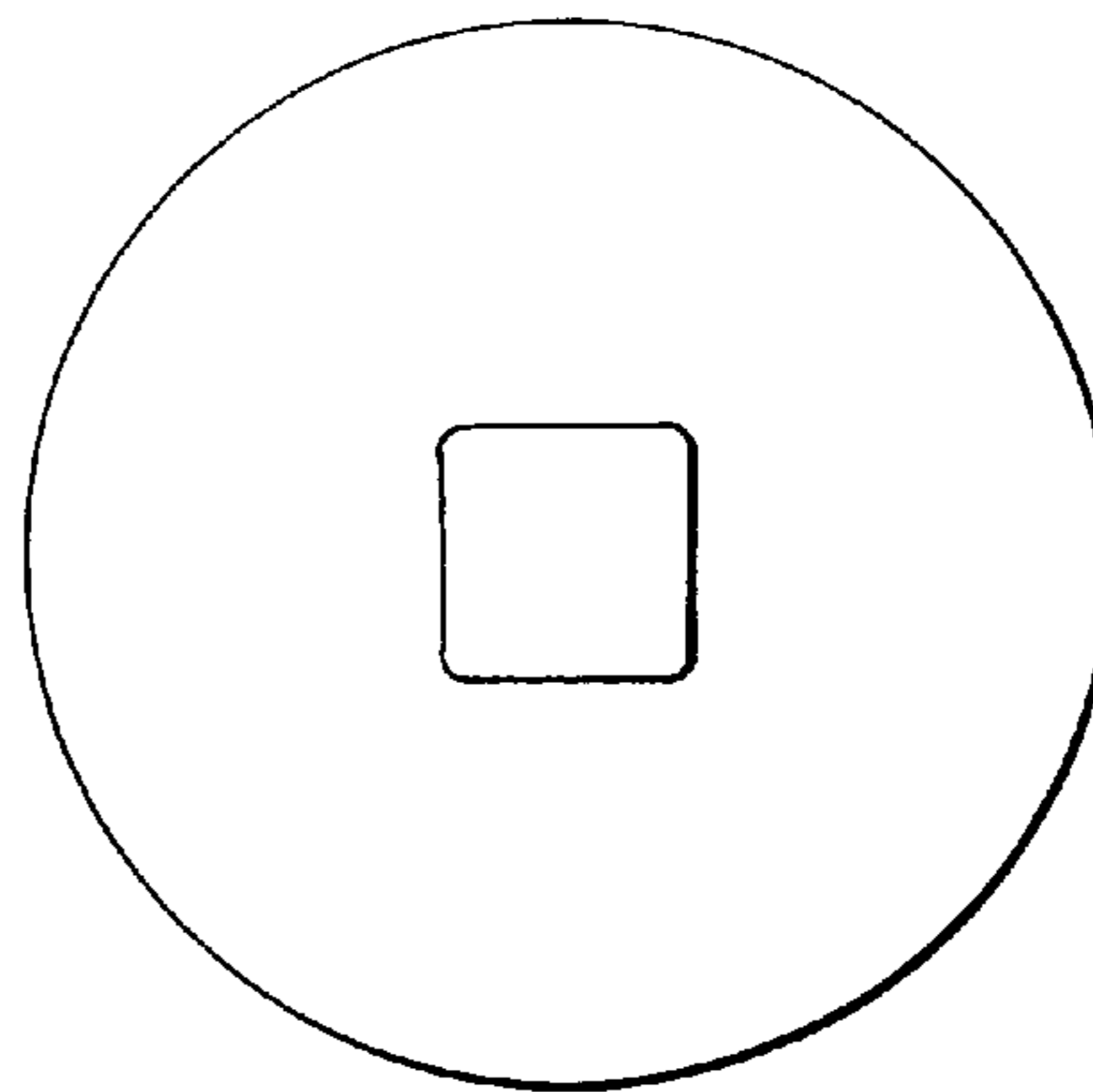
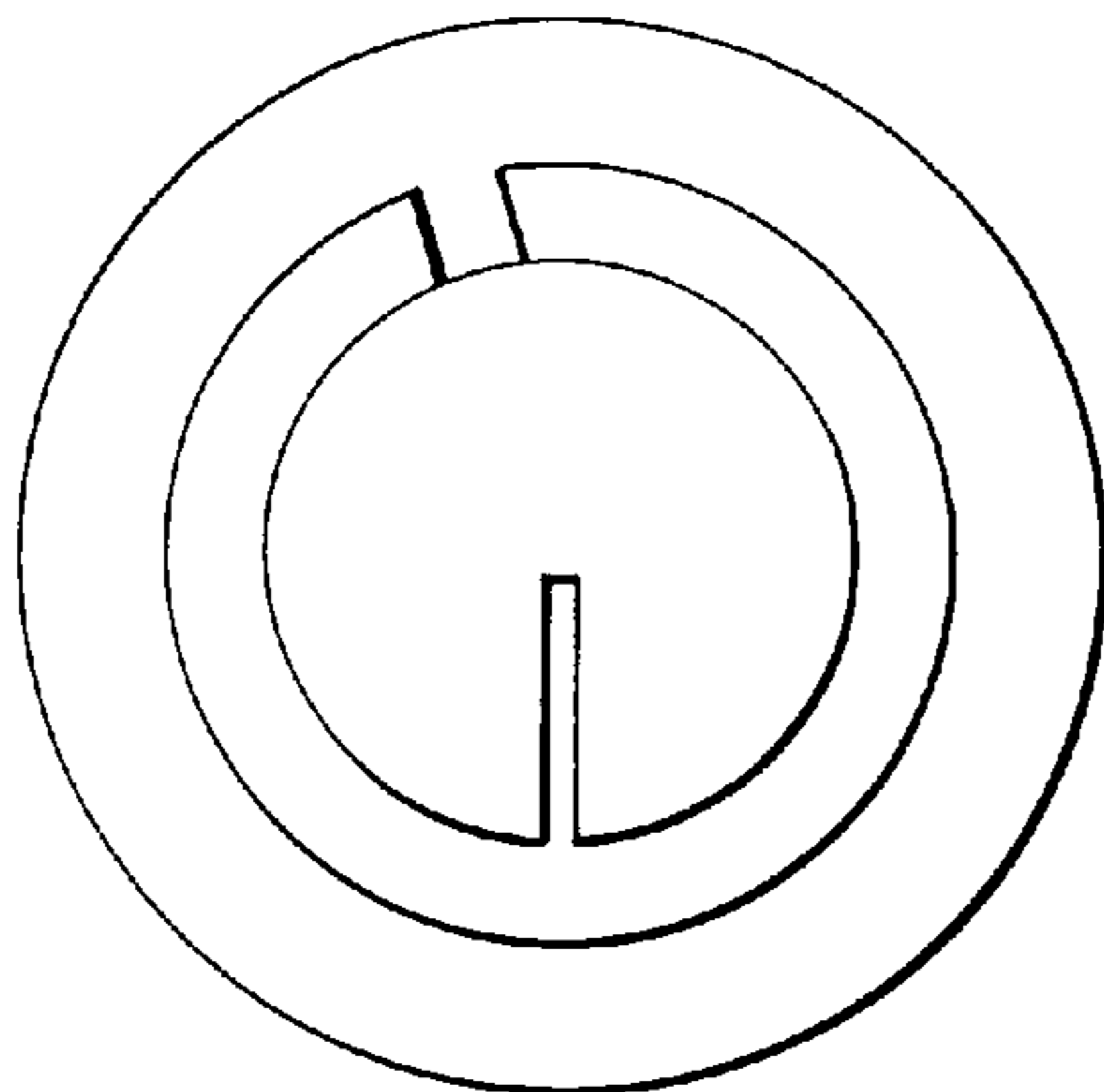
(57) **CLAIM**

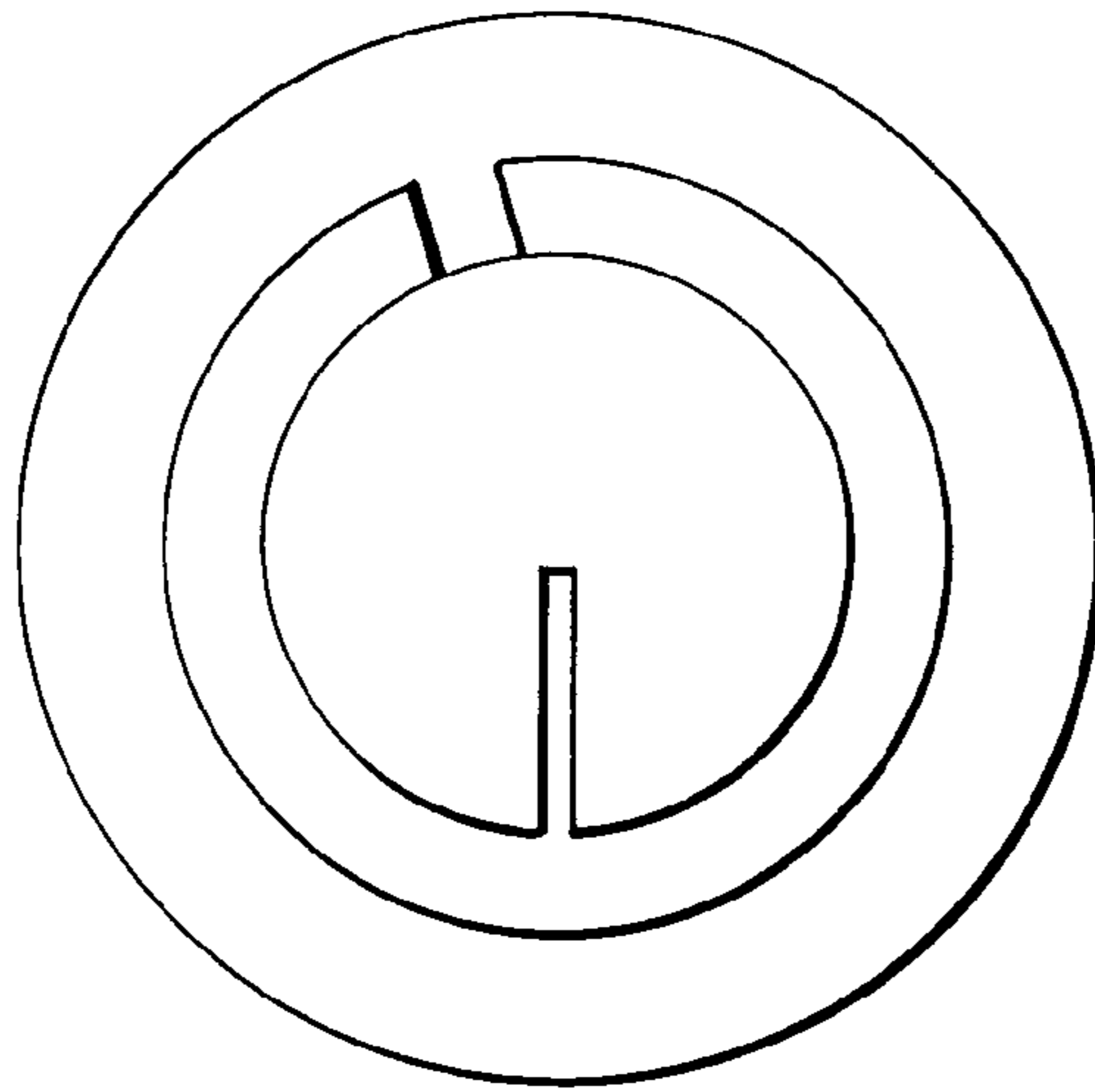
The ornamental design for a timepiece face, substantially as shown and described.

**DESCRIPTION**

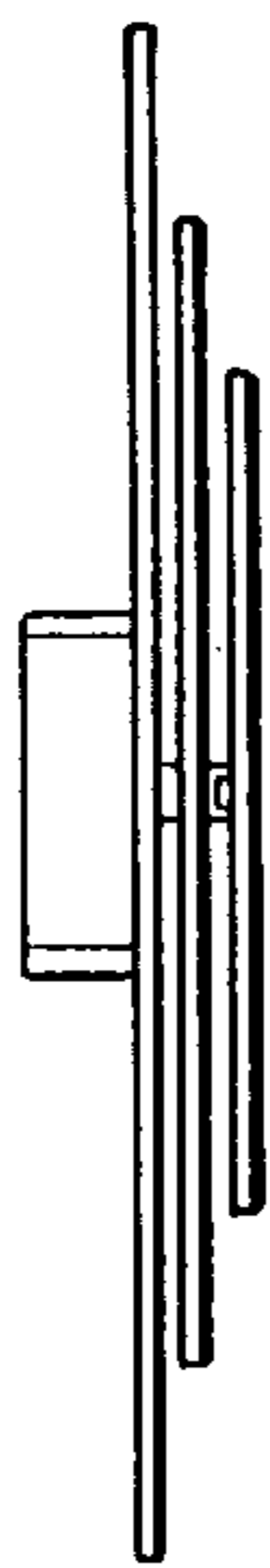
FIG. 1 is a front view of my invention;  
FIG. 2 is an elevation view thereof;  
FIG. 3 is a top elevation view thereof;  
FIG. 4 is another elevation view thereof;  
FIG. 5 is a bottom elevation view thereof;  
FIG. 6 is a rear view thereof;  
FIG. 7 is a front view of a second embodiment of my invention;  
FIG. 8 is an elevation view thereof;  
FIG. 9 is a top elevation view thereof;  
FIG. 10 is another elevation view thereof;  
FIG. 11 is a bottom elevation view thereof; and,  
FIG. 12 is a rear view thereof.

**1 Claim, 2 Drawing Sheets**

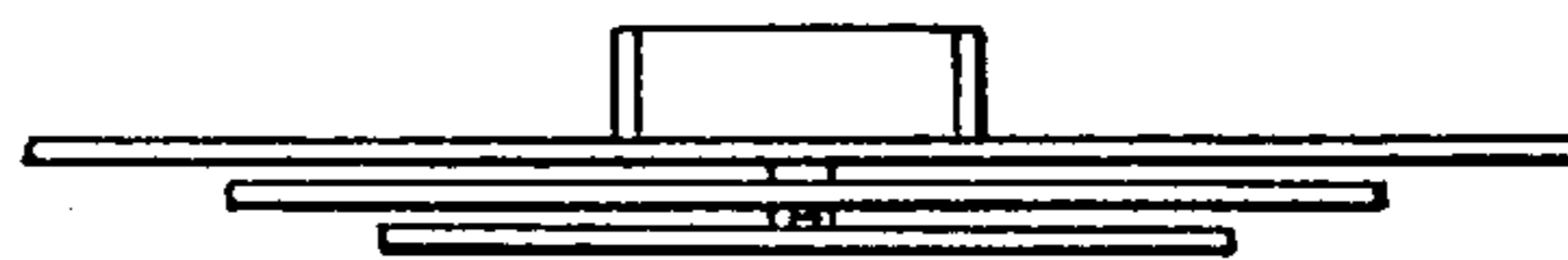




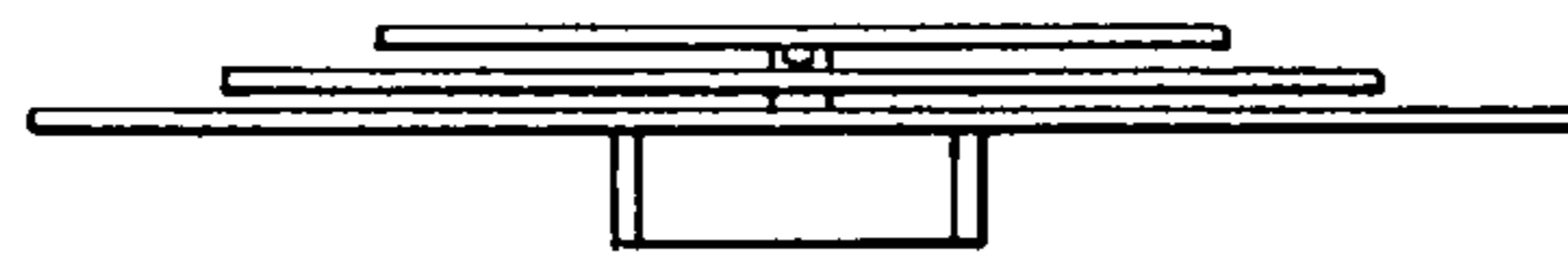
**Fig. 1**



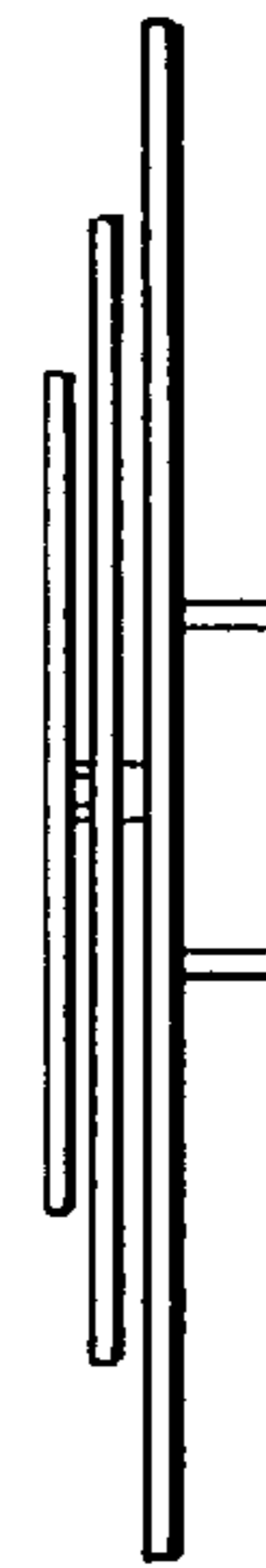
**Fig. 2**



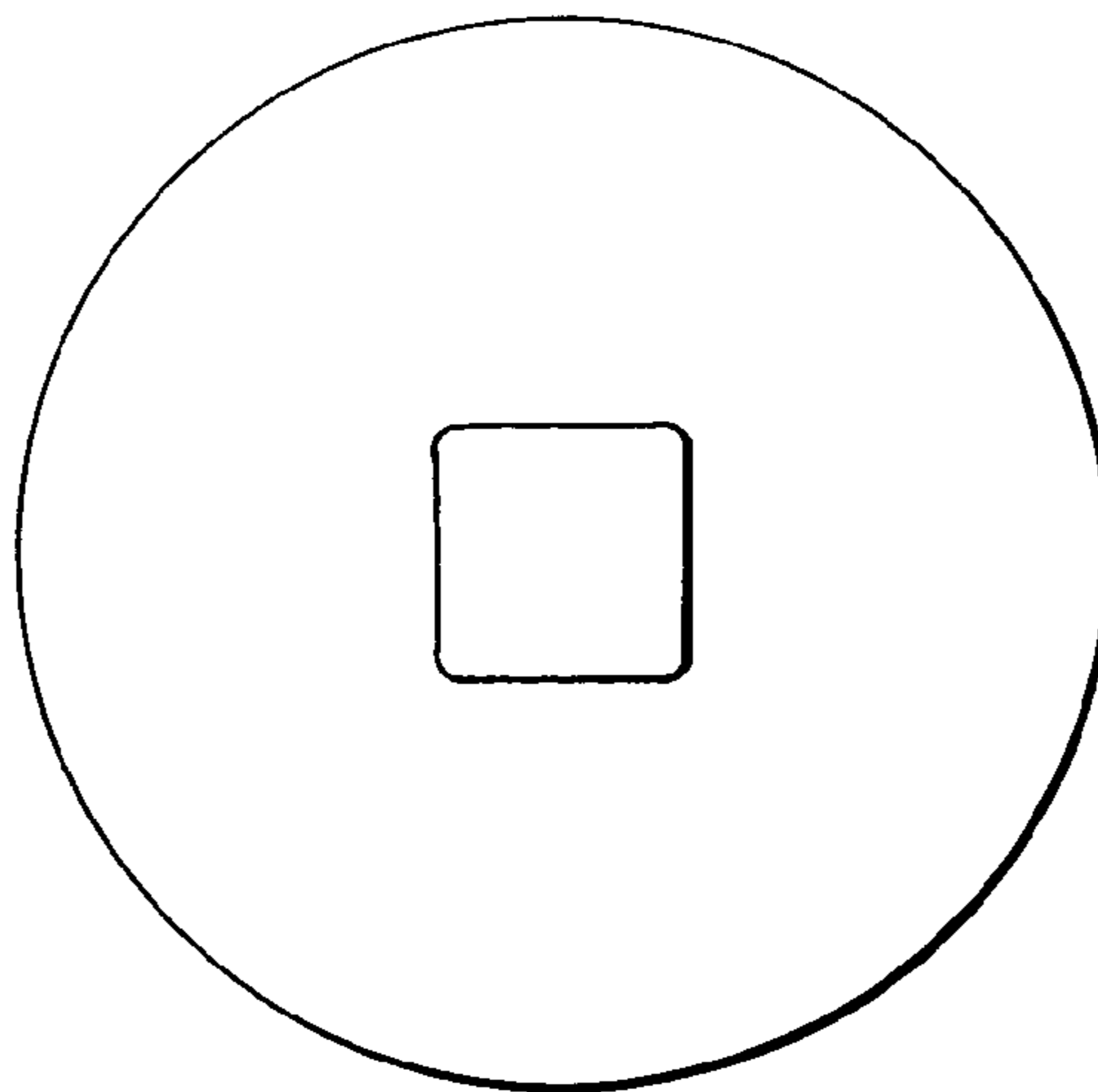
**Fig. 3**



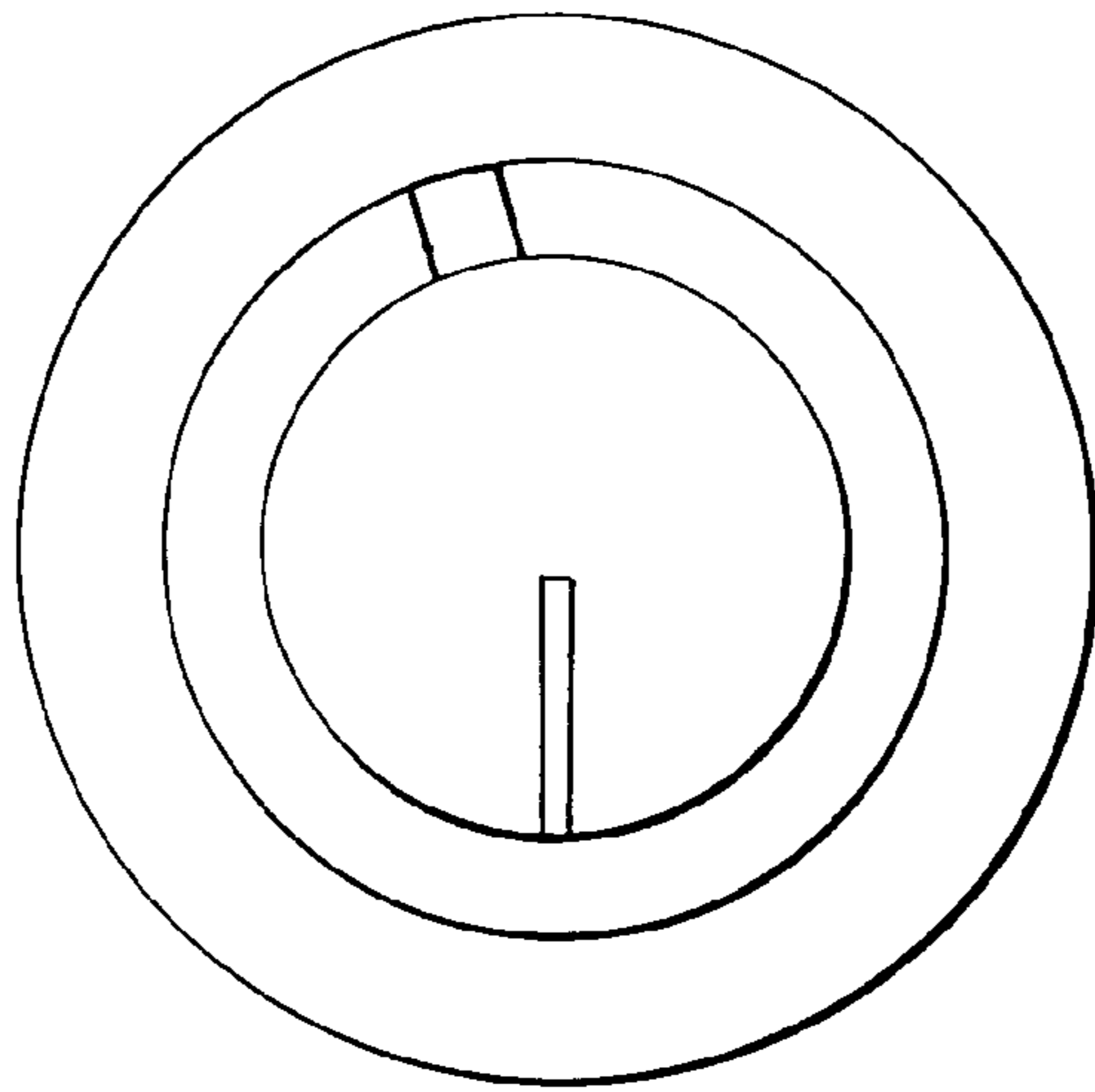
**Fig. 5**



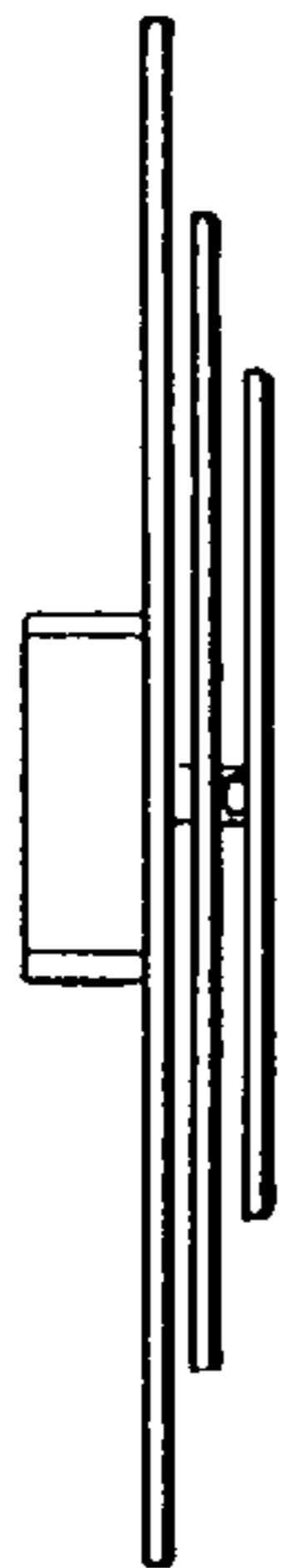
**Fig. 4**



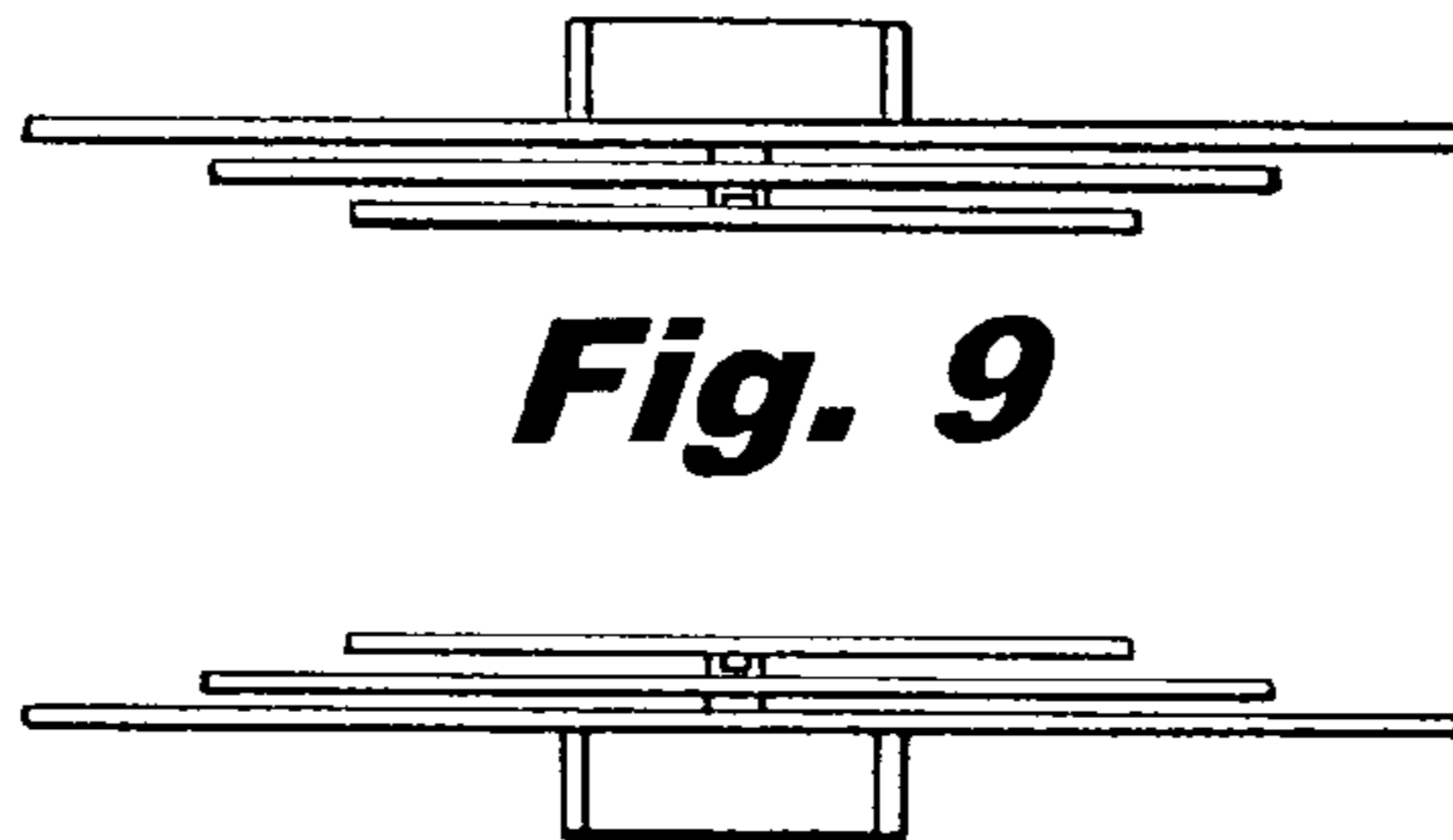
**Fig. 6**



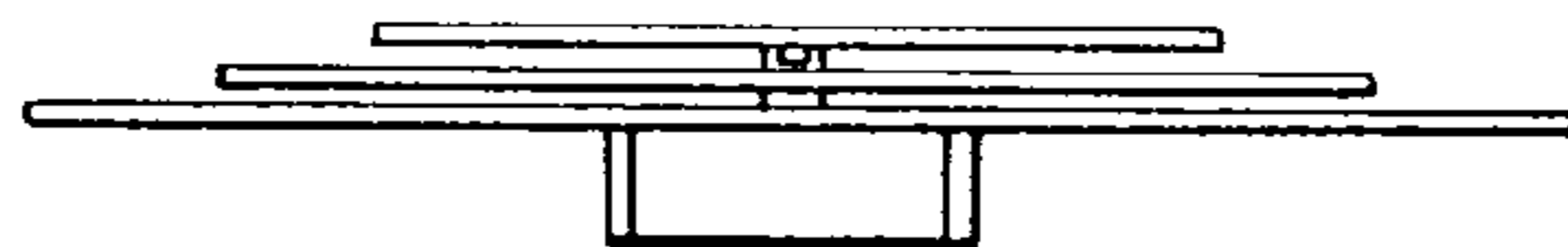
**Fig. 7**



**Fig. 8**



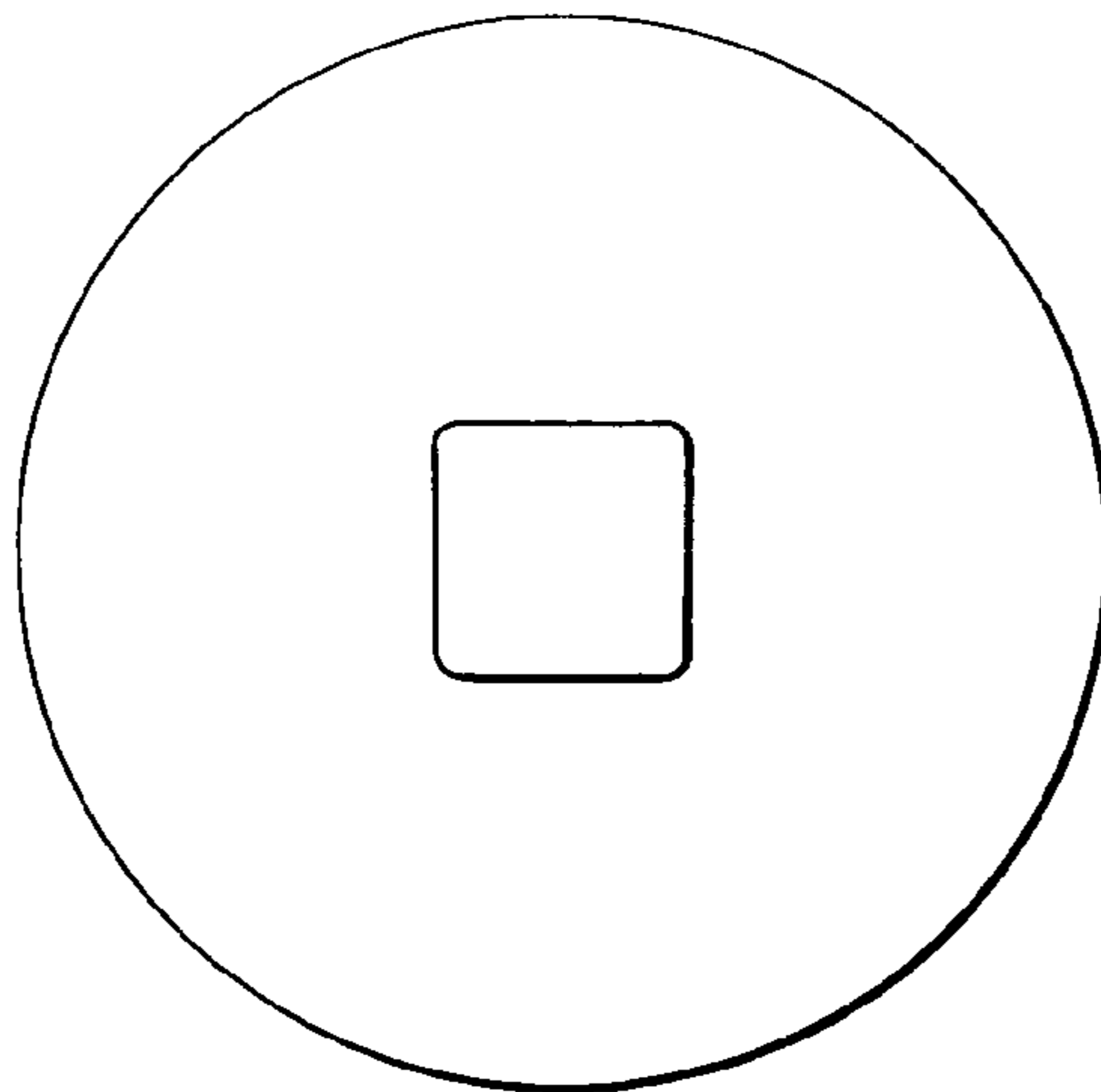
**Fig. 9**



**Fig. 11**



**Fig. 10**



**Fig. 12**