



US00D547053S

(12) **United States Design Patent**
Labelson

(10) **Patent No.:** **US D547,053 S**

(45) **Date of Patent:** **** Jul. 24, 2007**

(54) **ACCESSORY HOLDER**

6,318,610 B1 * 11/2001 Doherty 224/271
D473,034 S * 4/2003 Styne D2/624
D495,853 S * 9/2004 Nelson D2/627

(75) Inventor: **Ross Labelson**, Westbury, NY (US)

(73) Assignee: **Buckle-Down, Inc.**, Westbury, NY (US)

(**) Term: **14 Years**

* cited by examiner

Primary Examiner—Ralf Seifert

(74) *Attorney, Agent, or Firm*—Jones Day

(21) Appl. No.: **29/237,027**

(57) **CLAIM**

(22) Filed: **Aug. 26, 2005**

The ornamental design for an accessory holder, as shown and described.

(51) **LOC (8) Cl.** **03-01**

(52) **U.S. Cl.** **D3/208**

(58) **Field of Classification Search** D3/207–212;
206/37.1, 38.1; 150/147; 70/456 R, 456 B,
70/458–459; 24/3 K, 3.6, 100; D11/44, 48,
D11/200, 201, 216

See application file for complete search history.

DESCRIPTION

FIG. 1 is a perspective view of an accessory holder with a female end of the holder being fixed to a bag or other object; FIG. 2 is a front view of the holder; FIG. 3 is a rear view of the holder; FIG. 4 is a side view of the holder; FIG. 5 is a top view of the holder; FIG. 6 is a bottom view of the holder; and, FIG. 7 is a perspective view of the holder with a male end of the holder removed from the female end of the holder.

The portions shown in broken lines are included for illustrative purpose only and form no part of the claimed design.

(56) **References Cited**

U.S. PATENT DOCUMENTS

3,104,440 A * 9/1963 Davis 24/646
D234,548 S * 3/1975 Stahel D3/207
D322,160 S * 12/1991 Dauterive D2/627
D353,932 S * 1/1995 New D2/627

1 Claim, 4 Drawing Sheets

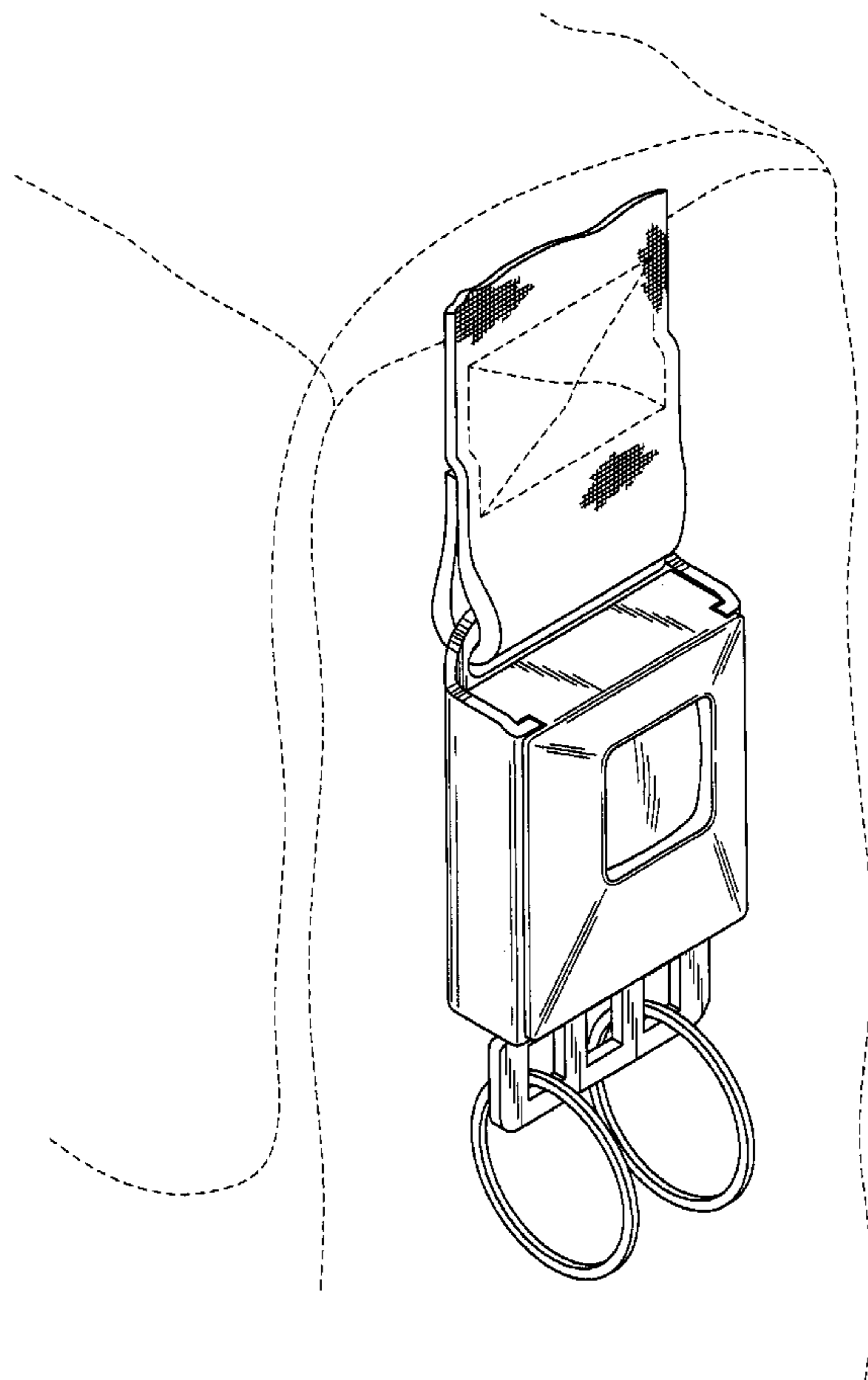

FIG. 1

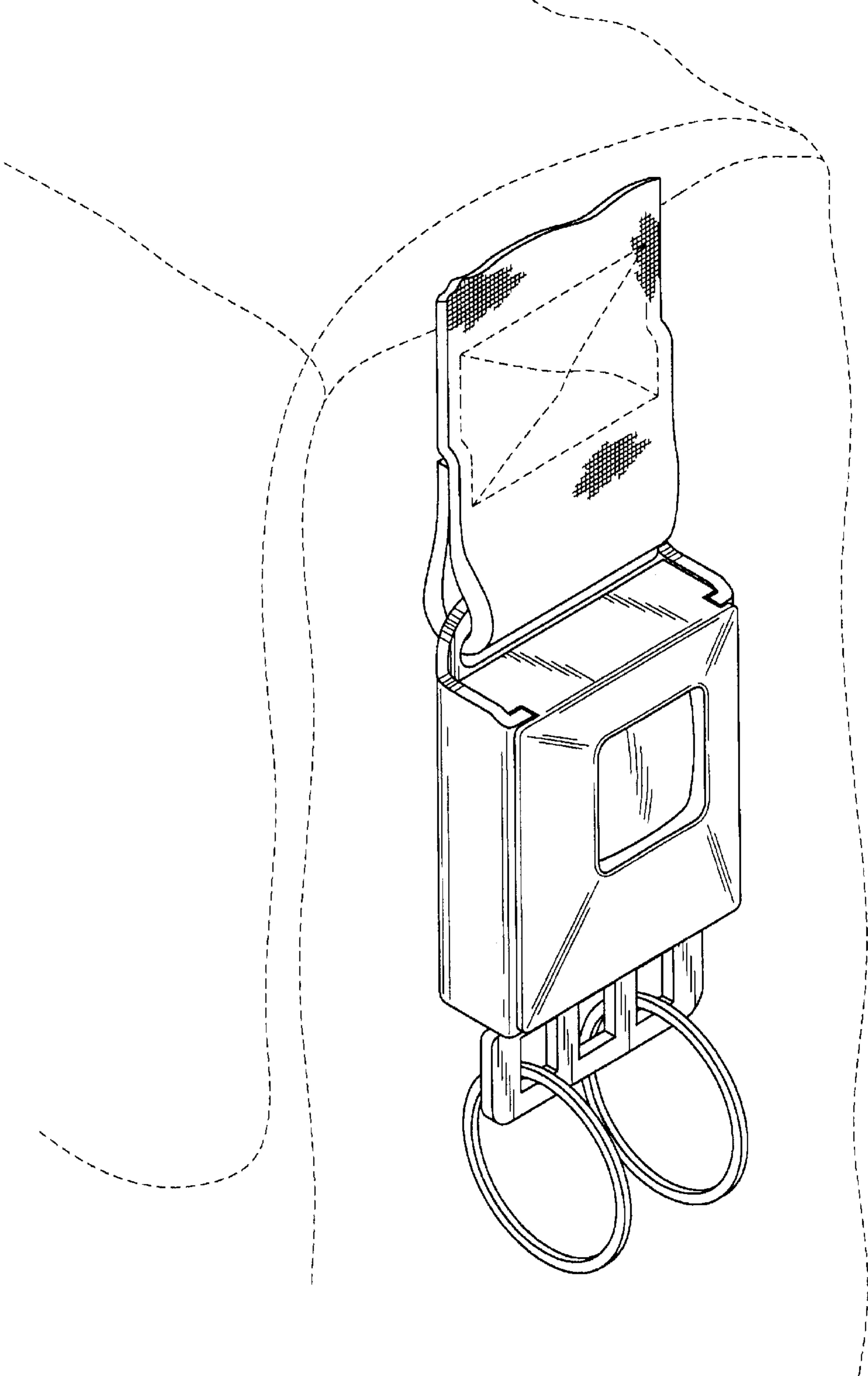

FIG. 2

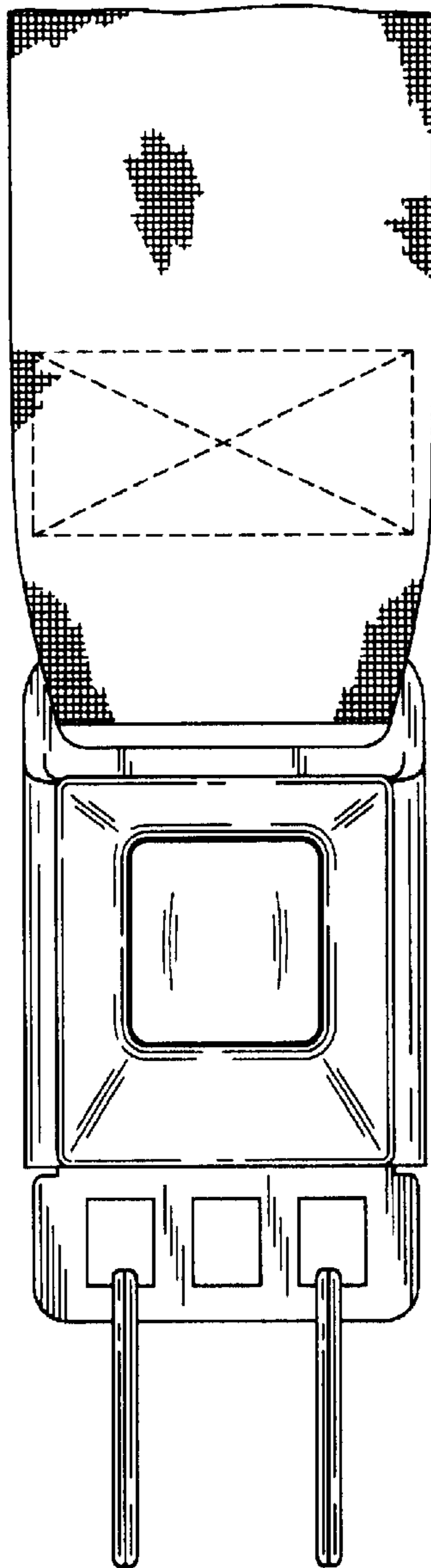

FIG. 3

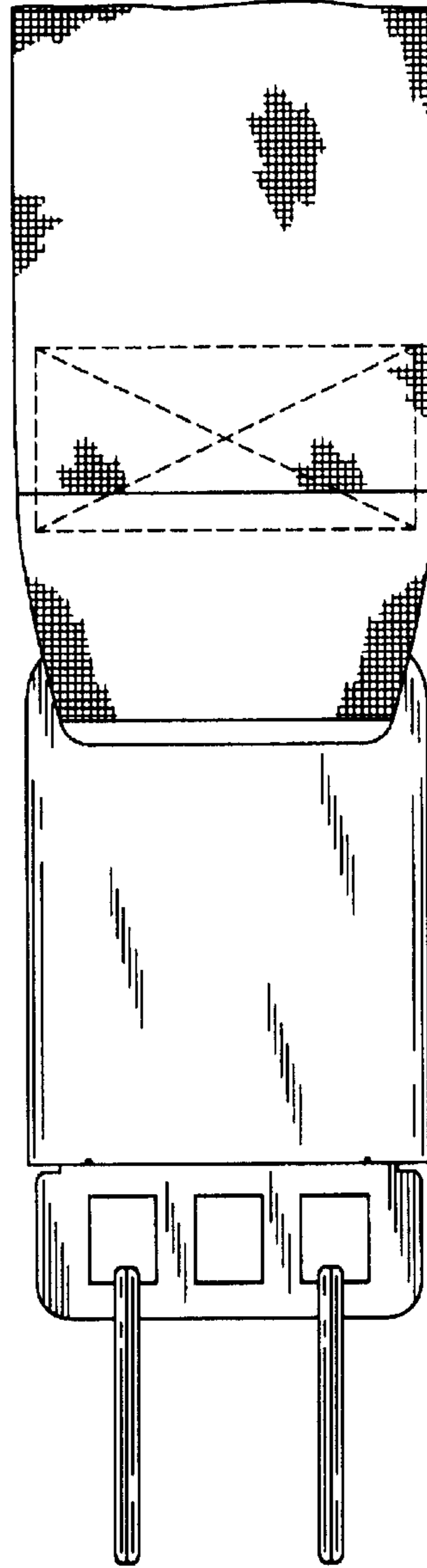

FIG. 4

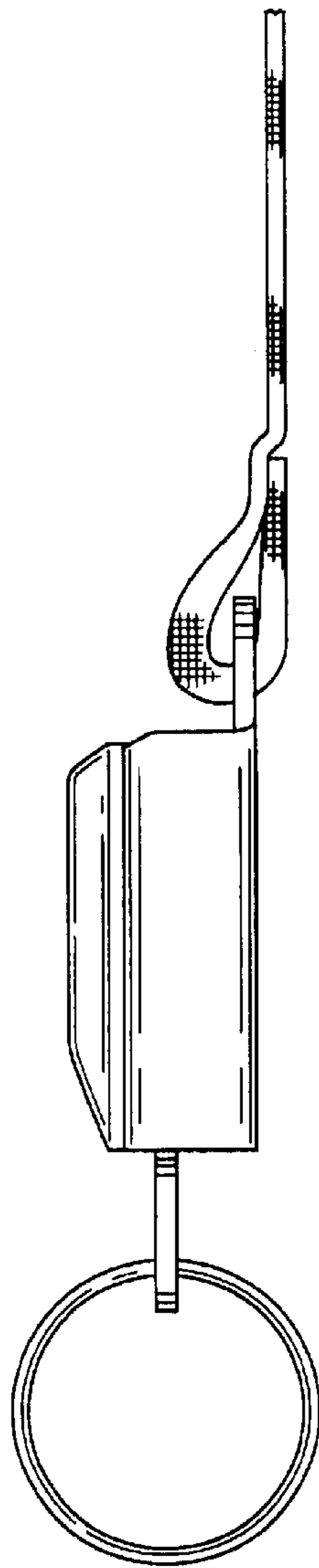

FIG. 6

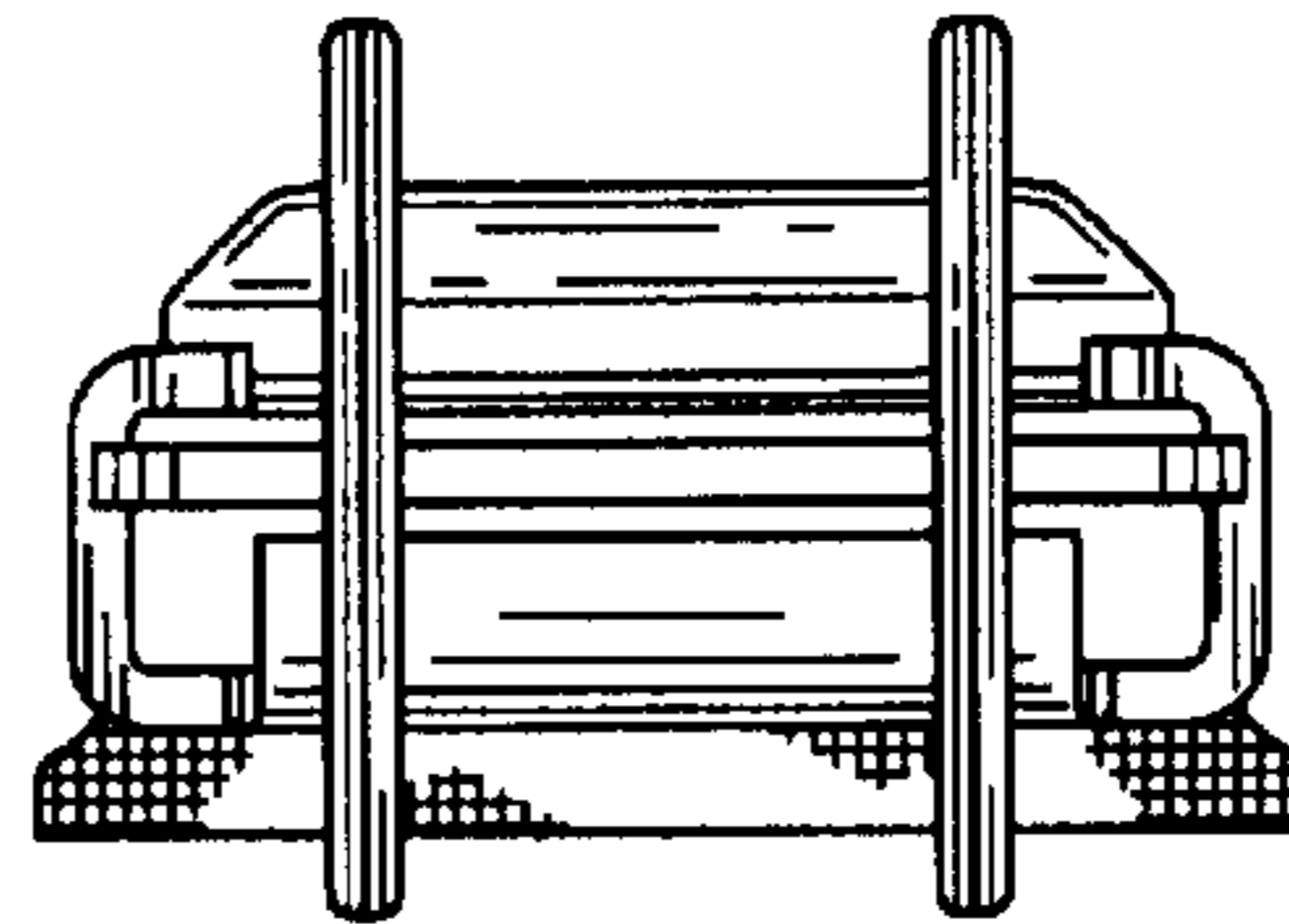

FIG. 5

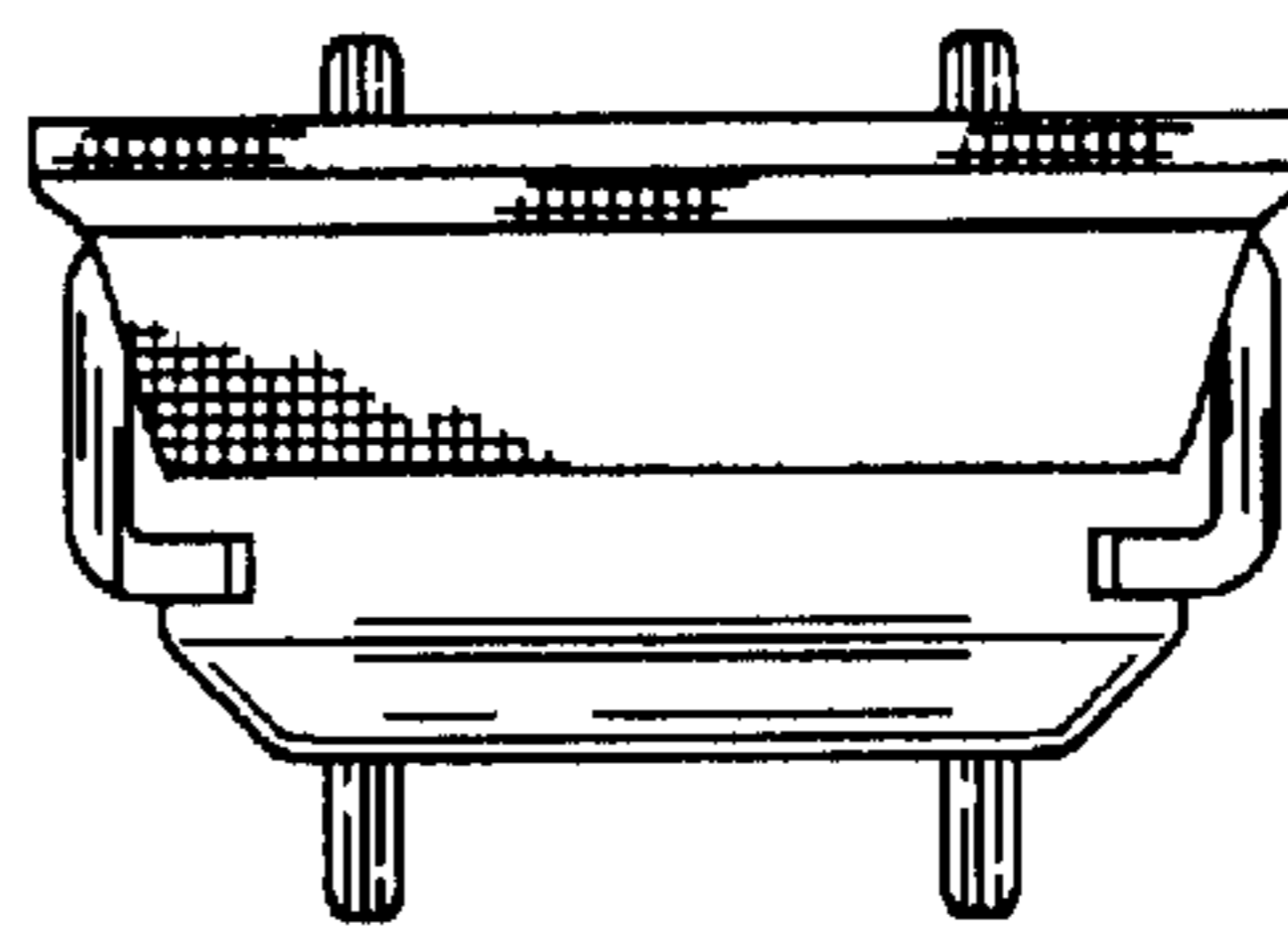

FIG. 7

