



US00D546962S

(12) **United States Design Patent**
Wu

(10) **Patent No.:** **US D546,962 S**

(45) **Date of Patent:** **** Jul. 17, 2007**

(54) **CONTROL DEVICE**

D523,561 S * 6/2006 Telford D24/215
2004/0030273 A1* 2/2004 Tucker 601/70

(75) Inventor: **Wei Wu**, Huzhou (CN)

* cited by examiner

(73) Assignee: **Zhejiang Lover Health Science and
Technology Development Co., Ltd.**,
Zhejiang Province (CN)

Primary Examiner—Ian Simmons
Assistant Examiner—Melanie Levy

(**) Term: **14 Years**

(57) **CLAIM**

(21) Appl. No.: **29/276,462**

The ornamental design for a control device, as shown and described.

(22) Filed: **Jan. 26, 2007**

DESCRIPTION

(51) **LOC (8) Cl.** **28-03**

(52) **U.S. Cl.** **D24/215**

(58) **Field of Classification Search** D24/211–215,
D24/200, 143; 601/46, 101, 87, 84, 80, 70,
601/85, 78, 67, DIG. 14, DIG. 16; 600/38;
D13/168, 169, 170, 174

FIG. 1 is a front elevational view of a control device showing my new design;

FIG. 2 is a rear elevational view thereof;

FIG. 3 is a right side view thereof;

FIG. 4 is a left side view thereof;

FIG. 5 is a top plan view thereof;

FIG. 6 is a bottom plan view thereof; and,

FIG. 7 is a perspective view thereof.

See application file for complete search history.

(56) **References Cited**

U.S. PATENT DOCUMENTS

D469,183 S * 1/2003 Gerth et al. D24/200
D496,333 S * 9/2004 Nan D13/103

1 Claim, 6 Drawing Sheets

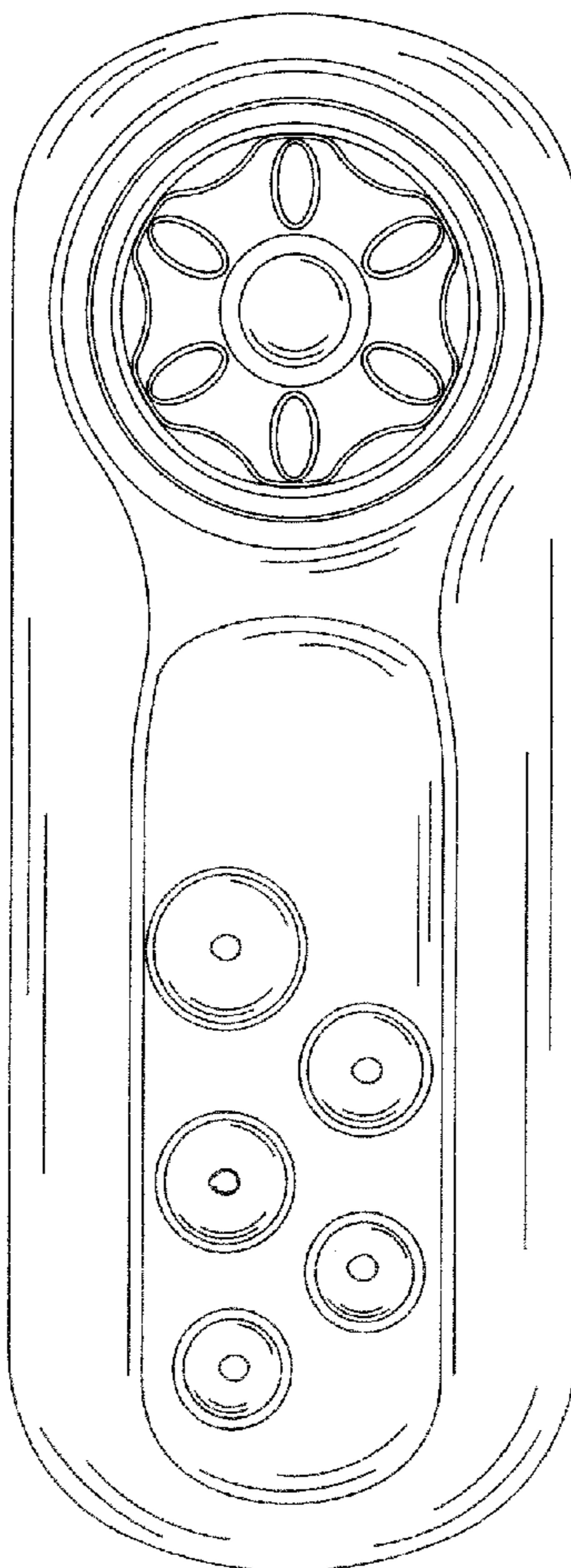

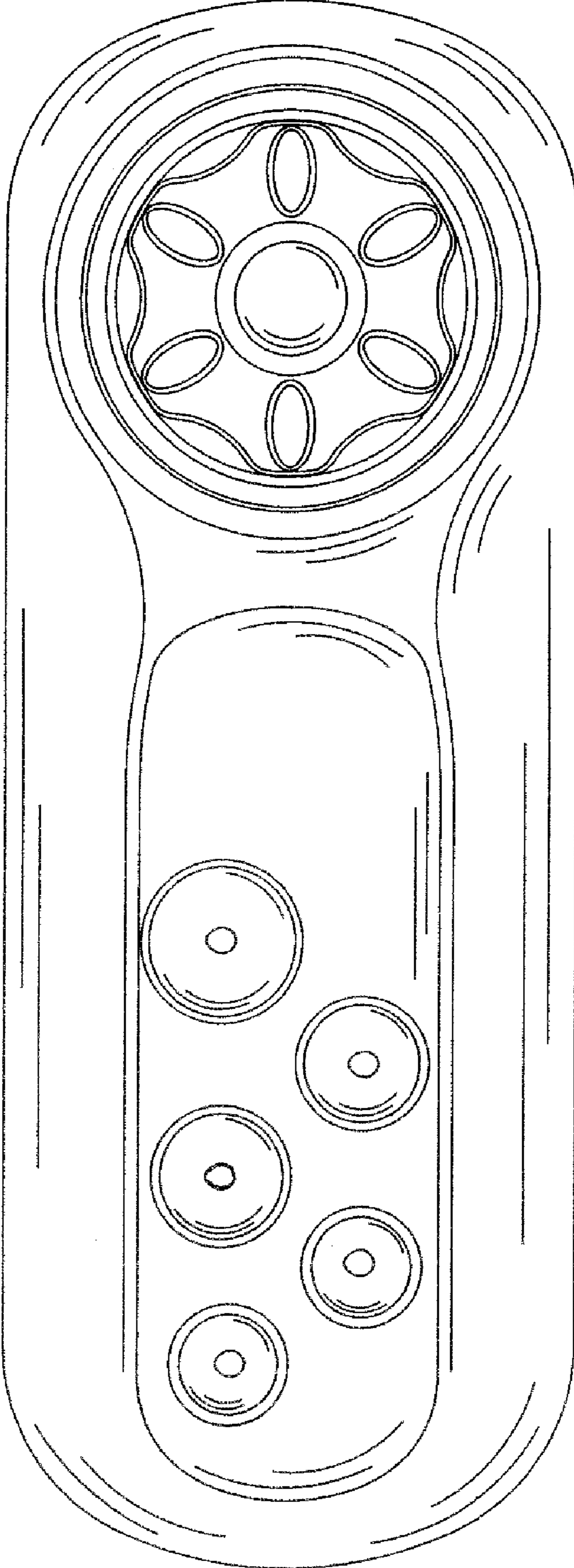

FIG. 1

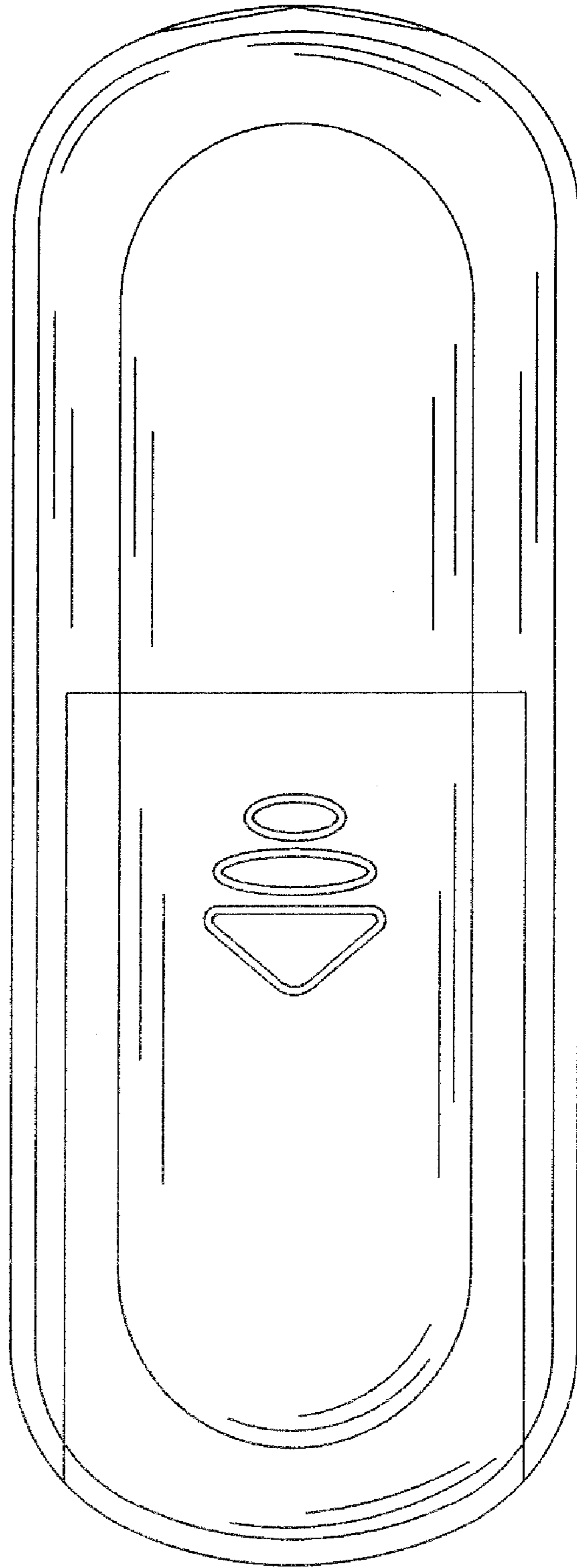

FIG. 2

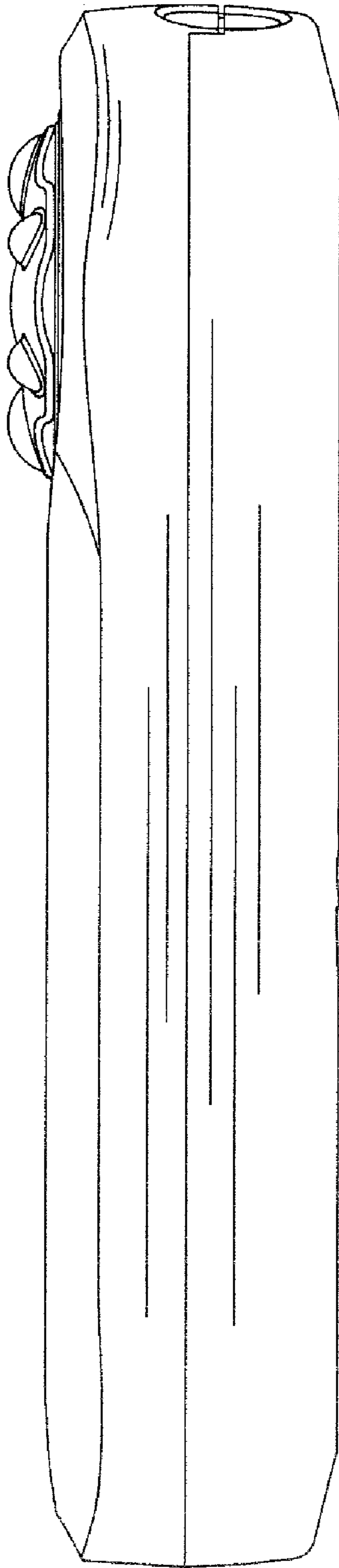

FIG. 3

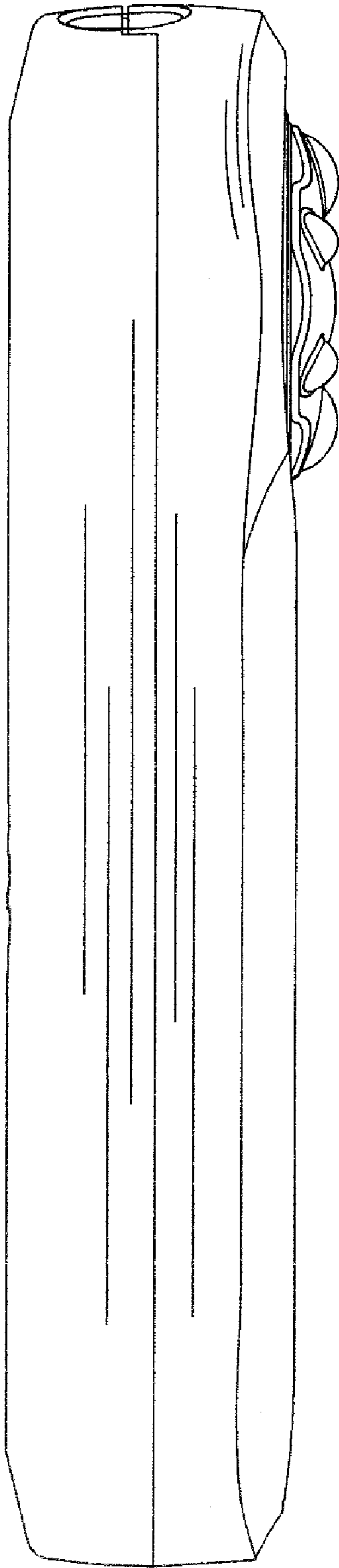

FIG. 4

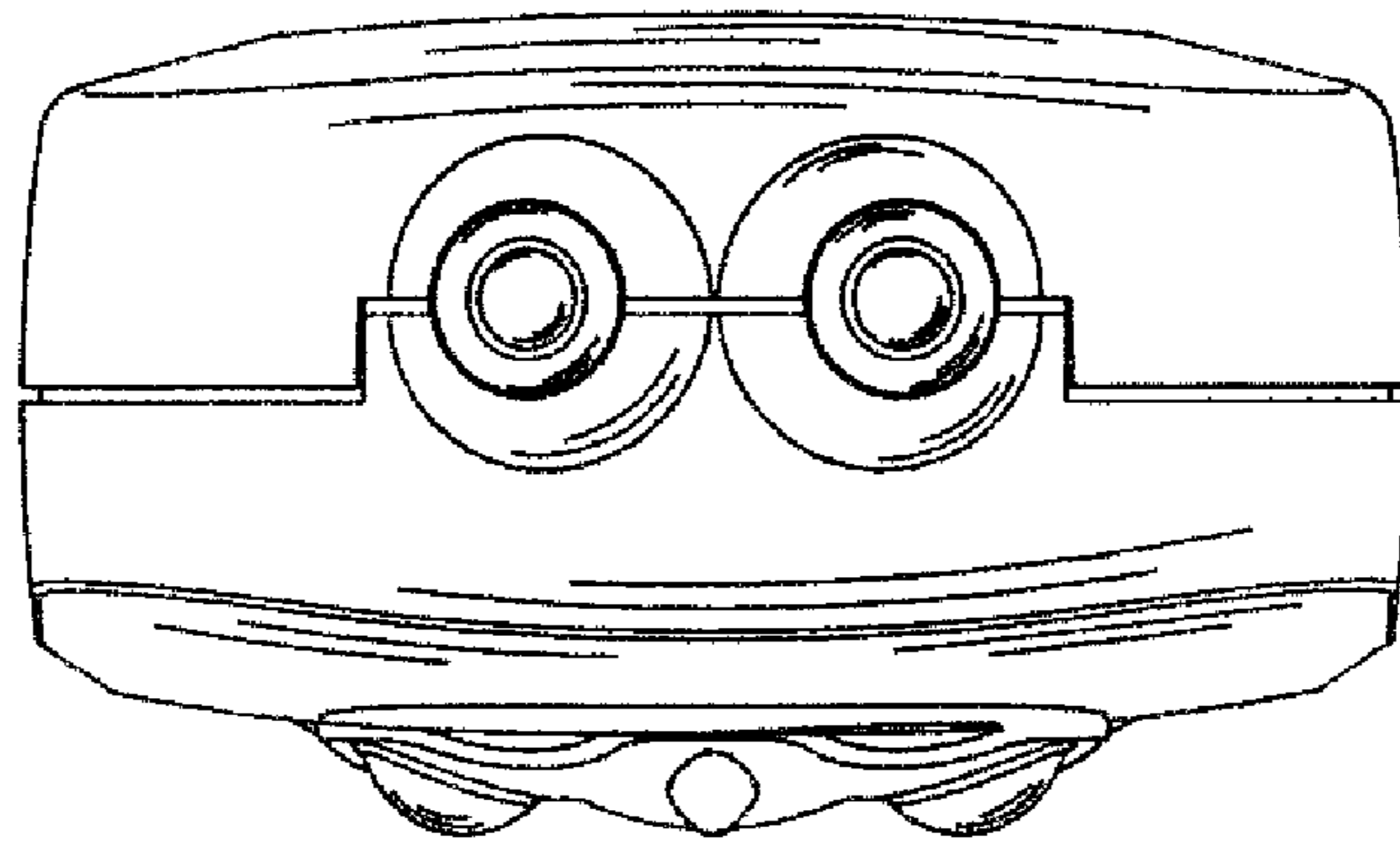

FIG. 5

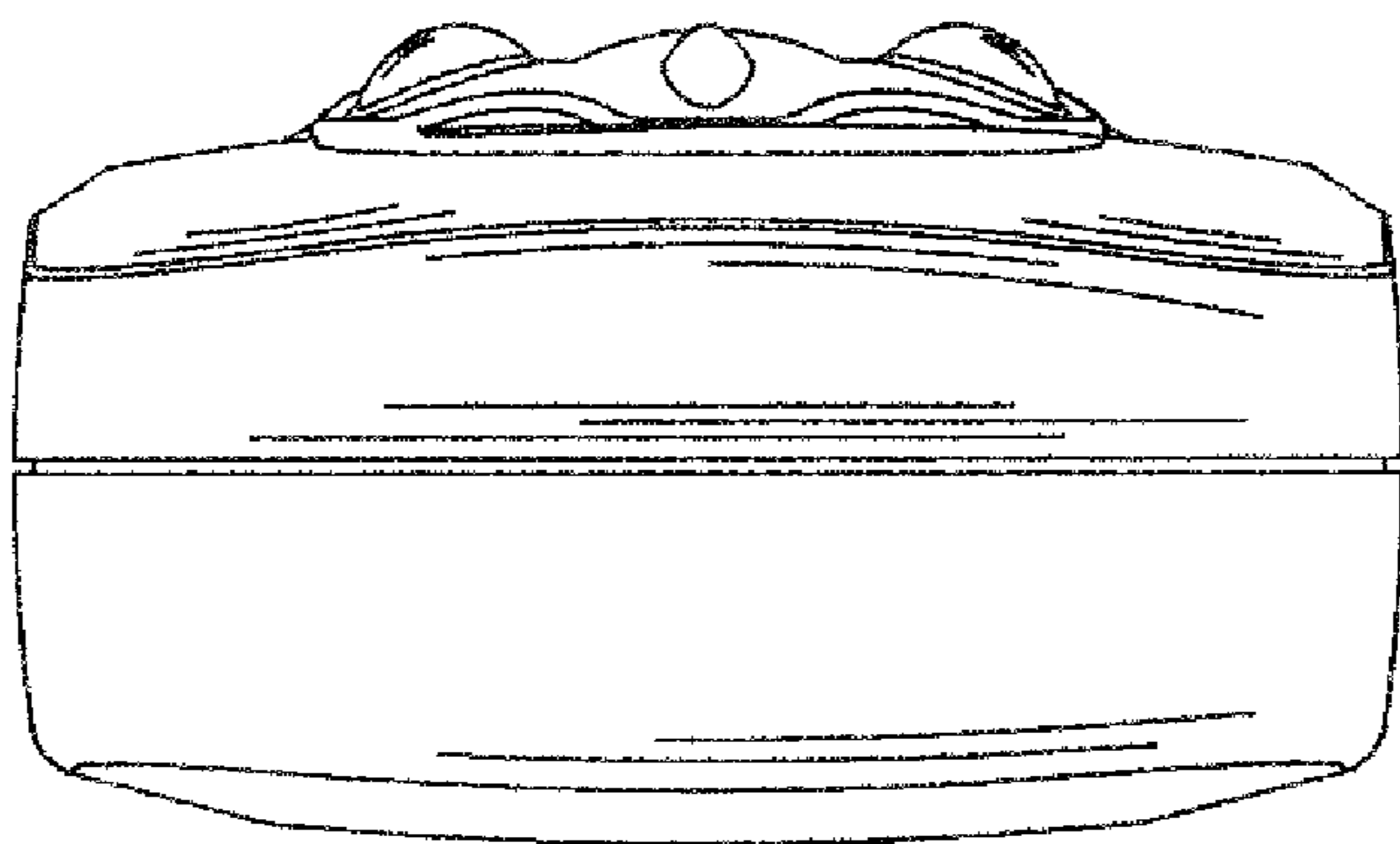

FIG. 6

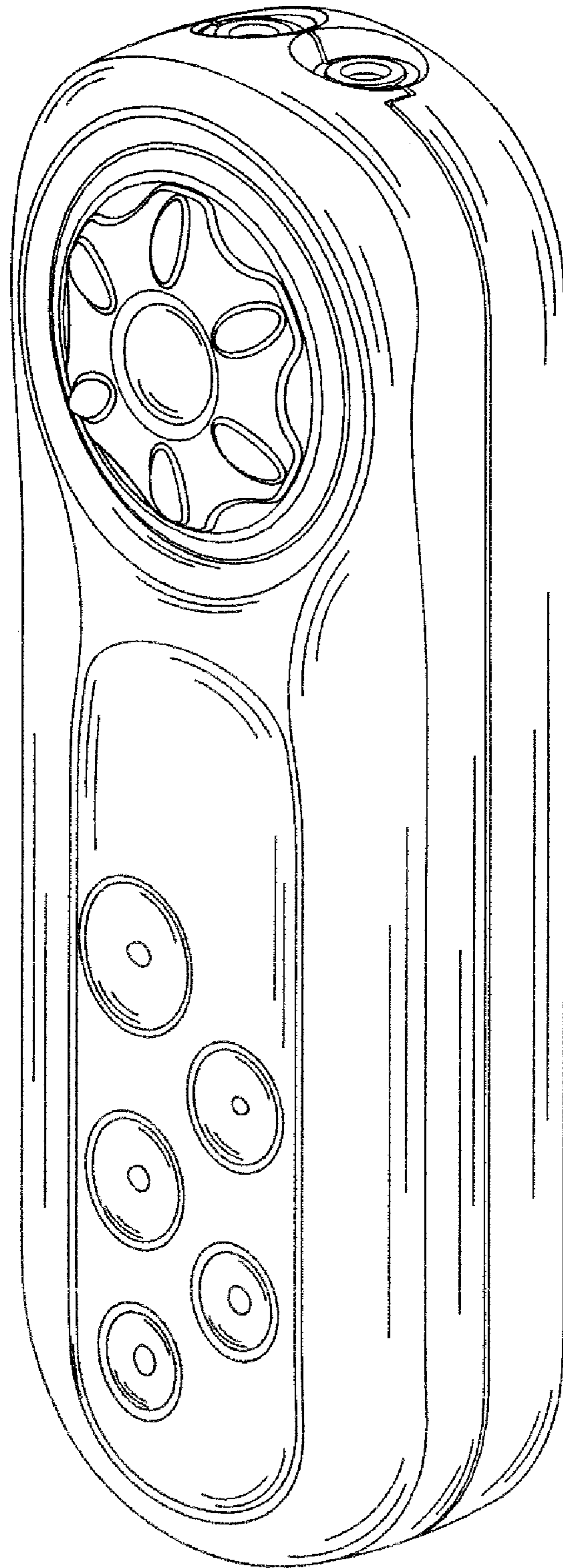

FIG. 7