

US00D546927S

(12) **United States Design Patent**
Ziemann

(10) **Patent No.:** **US D546,927 S**
(45) **Date of Patent:** **** Jul. 17, 2007**

- (54) **SINK**
- (75) Inventor: **Brigitte Ziemann**, Eppingen (DE)
- (73) Assignee: **Blanco GmbH + Co KG** (DE)
- (**) Term: **14 Years**
- (21) Appl. No.: **29/242,600**
- (22) Filed: **Nov. 10, 2005**
- (30) **Foreign Application Priority Data**

May 11, 2005 (EM) 000344775

- (51) **LOC (8) Cl.** **23-02**
 - (52) **U.S. Cl.** **D23/290**
 - (58) **Field of Classification Search** D23/290,
D23/303, 308; 4/639-642
- See application file for complete search history.

(56) **References Cited**

U.S. PATENT DOCUMENTS

4,039,077 A	8/1977	Sorenson	
4,584,822 A	4/1986	Fielding et al.	
5,653,550 A	8/1997	Mutz et al.	
5,860,172 A	1/1999	Pfeiffer	
RE37,253 E	7/2001	Moren et al.	
6,308,351 B1	10/2001	Franke	
6,382,422 B1	5/2002	Bocek	
D465,271 S *	11/2002	Ris	D23/290
D467,650 S *	12/2002	Ris	D23/290
D508,555 S	8/2005	Ziemann	
D518,881 S	4/2006	Ziemann	
2003/0041374 A1	3/2003	Franke	
2004/0078892 A1	4/2004	Albarran	
2005/0205193 A1	9/2005	Von Mertz	
2005/0263427 A1	12/2005	Schneider et al.	

FOREIGN PATENT DOCUMENTS

DE	1920893 A	11/1970
DE	1628684	12/1970
DE	2640935 A1	3/1977

DE	2813088 A	10/1979
DE	7820319 U1	12/1979
DE	3 110 134	10/1982
DE	3925590 A	2/1991
DE	4241023 A	6/1994
DE	4437630	1/1996
DE	29620839 U1	3/1997
DE	29822399 U1	4/1999
EP	0685021 B1	12/1995
EP	0 709 528	5/1996
EP	0 976 881	2/2000
EP	1 103 665	5/2001
EP	1188685 A2	3/2002
FR	1319427	3/1963

(Continued)

OTHER PUBLICATIONS

Sink shown in advertisement for NKBA Designer Professionals, House and Garden magazine, Sep. 2005: vol. 174, No. 9.*

(Continued)

Primary Examiner—Robert A. Delehanty
(74) *Attorney, Agent, or Firm*—Hanley, Flight & Zimmerman, LLC

(57) **CLAIM**

The ornamental design for a “sink,” as shown and described.

DESCRIPTION

FIG. 1 is a top, left perspective view of a sink showing my new design.

FIG. 2 is a top plan view of the sink of FIG. 1.

FIG. 3 is a bottom plan view of the sink of FIG. 1.

FIG. 4 is a front view of the sink of FIG. 1.

FIG. 5 is a rear view of the sink of FIG. 1.

FIG. 6 is a right side view of the sink of FIG. 1; and,

FIG. 7 is a left side view of the sink of FIG. 1.

1 Claim, 7 Drawing Sheets

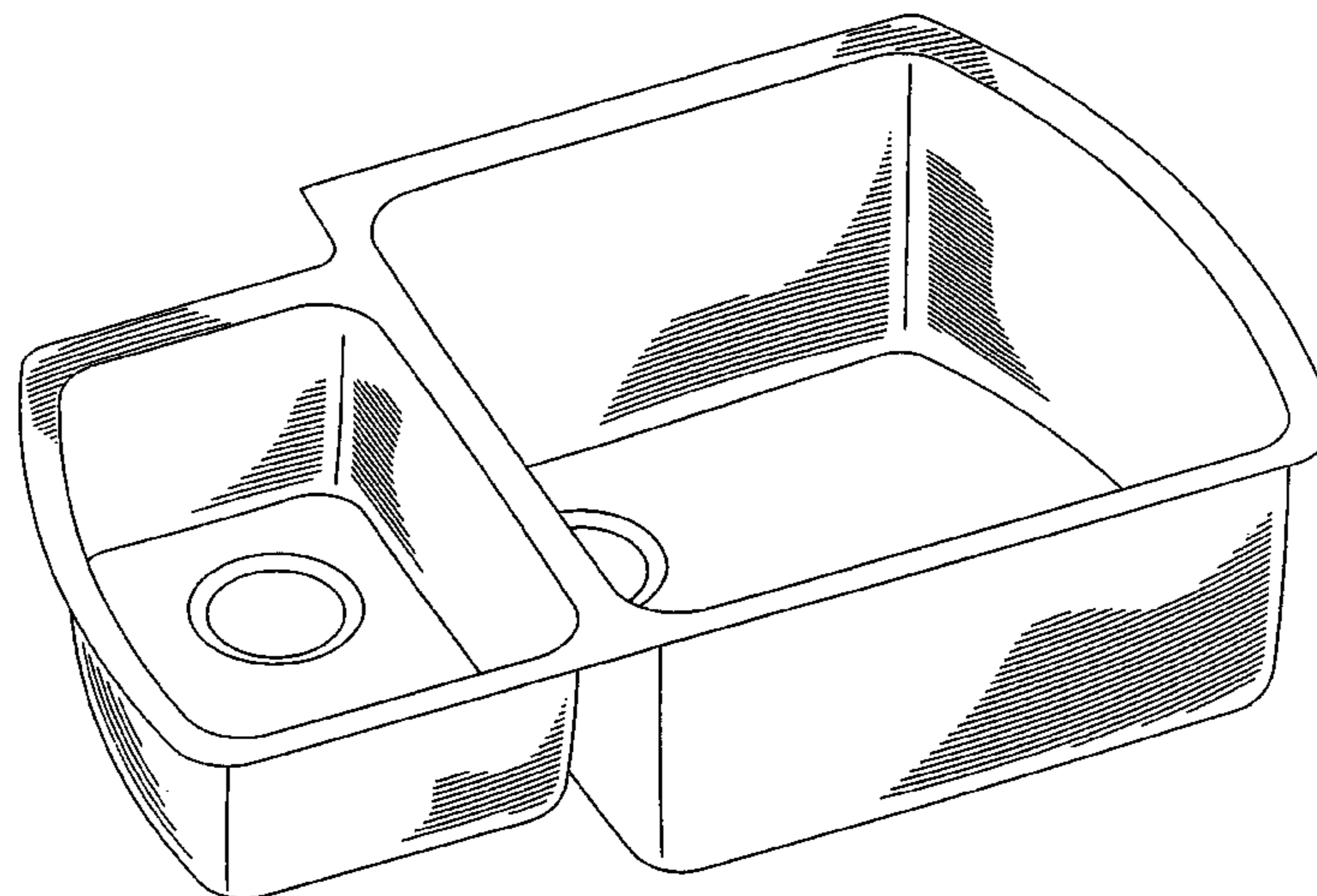

FOREIGN PATENT DOCUMENTS

FR	2430532	7/1979
FR	2 832 440	5/2003
GB	2108195 A	5/1983
GB	2263060 A	7/1993
JP	63272682	11/1988
JP	10029684	2/1998
NL	8201555	11/1983

OTHER PUBLICATIONS

European Patent Office Search Report for European Patent Application No. 04 012 865.4, Nov. 3, 2004 (3 pages).
 European Patent Office Search Report for European Patent Application No. 04 012 866.2, Nov. 12, 2004 (3 pages).
 International Search Report corresponding to International Application No. PCT/EP2004/012840 (5 pages).
 Office action of German Patent Office corresponding to German Application No. 103 55 032.1 (2 pages).
 International Search Report corresponding to International Application Serial No. PCT/EP2004/007830, Oct. 5, 2004, 3 pages.
 Ziemann, Brigitte, U.S. Appl. No. 29/225,634, filed Mar. 18, 2005 for "Sink."
 Schneider, Wolfgang, U.S. Appl. No. 11/140,830, filed May 31, 2005 for "Built-Under Sinks."
 Ziemann, Brigitte, U.S. Appl. No. 29/242,599, filed Nov. 10, 2005 for "Sink Performa V2 Big Single."
 Ziemann, Brigitte, U.S. Appl. No. 29/242,618, filed Nov. 10, 2005 for "Sink Performa K4 2.0 Small."
 Ziemann, Brigitte, U.S. Appl. No. 29/242,607, filed Nov. 10, 2005, for "Sink Performa K4 1.0 Large."
 Ziemann, Brigitte, U.S. Appl. No. 29/242,581, filed Nov. 10, 2005, for "Sink Performa K3 30 1.5."

Ziemann, Brigitte, U.S. Appl. No. 29/242,612, filed Nov. 10, 2005 for "Sink Performa V2 Single Bar."
 Ziemann, Brigitte, U.S. Appl. No. 29/242,608, filed Nov. 10, 2005 for "Sink Performa K4 1.0 Super Single."
 Ziemann, Brigitte, U.S. Appl. No. 29/242,611, filed Nov. 10, 2005 for "Sink Performa K4 1.5."
 Ziemann, Brigitte, U.S. Appl. No. 29/242,627, filed Nov. 10, 2005 for "Sink Performa K4 1.75."
 Schnedier, Wolfgang et al., U.S. Appl. No. 29/256,748, filed Mar. 24, 2006 for "Sink."
 Ziemann, Brigitte, U.S. Appl. No. 29/242,626, filed Nov. 10, 2005 for "Sink Performa K3 30 Single Bar."
 Schneider, Wolfgang, U.S. Appl. No. 29/240,298, filed Oct. 11, 2005, for "Sink."
 Ziemann, Brigitte, U.S. Appl. No. 29/242,610, filed Nov. 10, 2005 for "Sink Performa V2 Double."
 Von Mertz, Gert Spruner et al., U.S. Appl. No. 11/321,683, filed Dec. 28, 2005 for "A Movement Mechanism for Moving a Closure Element for the Purposes of Sealing a Waste Outlet Opening."
 Schneider, Wolfgang et al., U.S. Appl. No. 11/403,315, filed Apr. 13, 2006 for "Sink."
 Ziemann, Brigitte, U.S. Appl. No. 29/242,523, filed Nov. 10, 2005 for "Sink Performa K3 30 Double."
 Von Mertz, Gert Spruner, U.S. Appl. No. 11/057,961, filed Aug. 13, 2003, for "Installation Elements and Methods for Fastening an Installation Element to a Work Surface."
 Schneider, Wolfgang et al., U.S. Appl. No. 10/872,855, filed Jun. 21, 2004, for "Packaging for a Sink."

* cited by examiner

Fig. 1

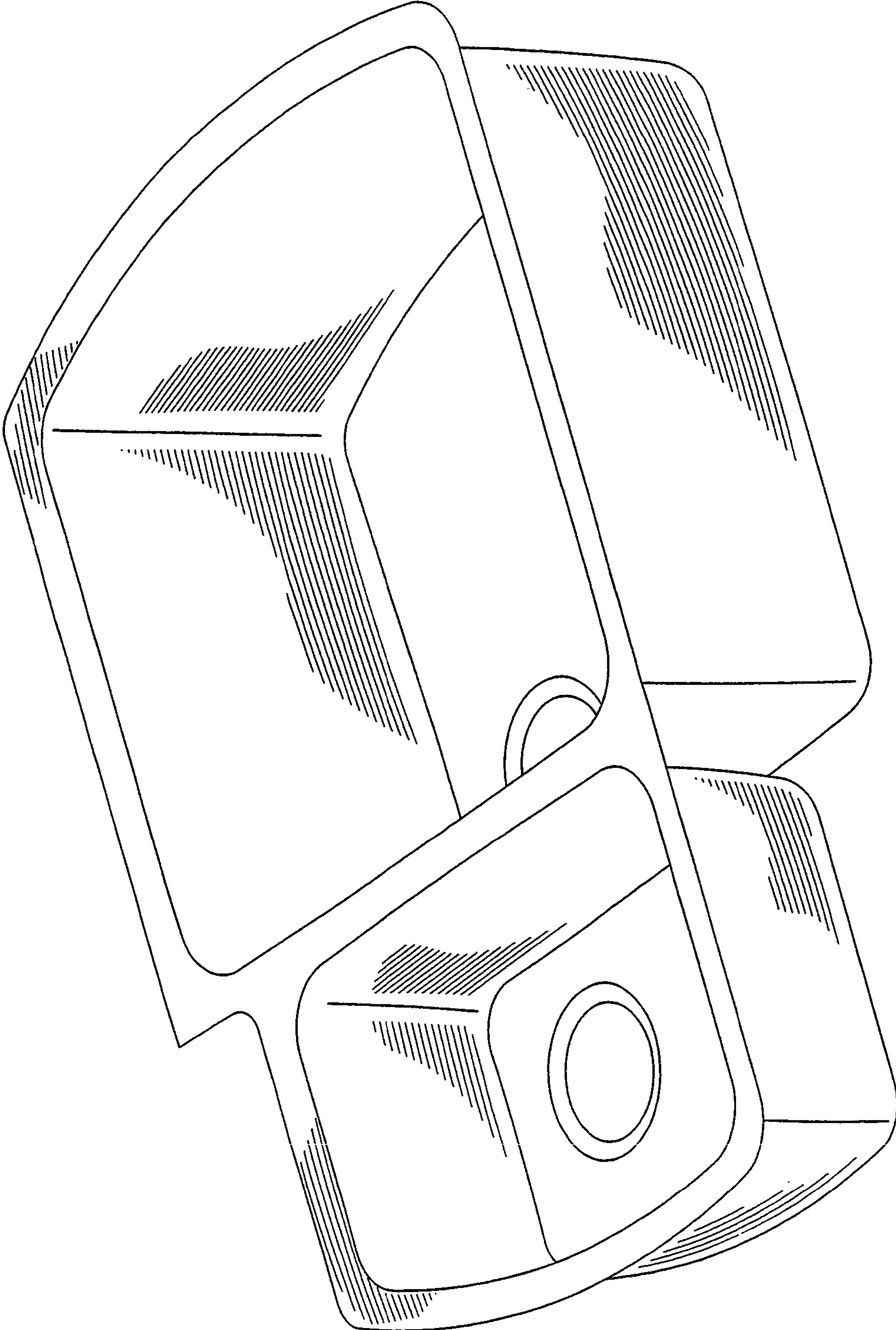

Fig. 2

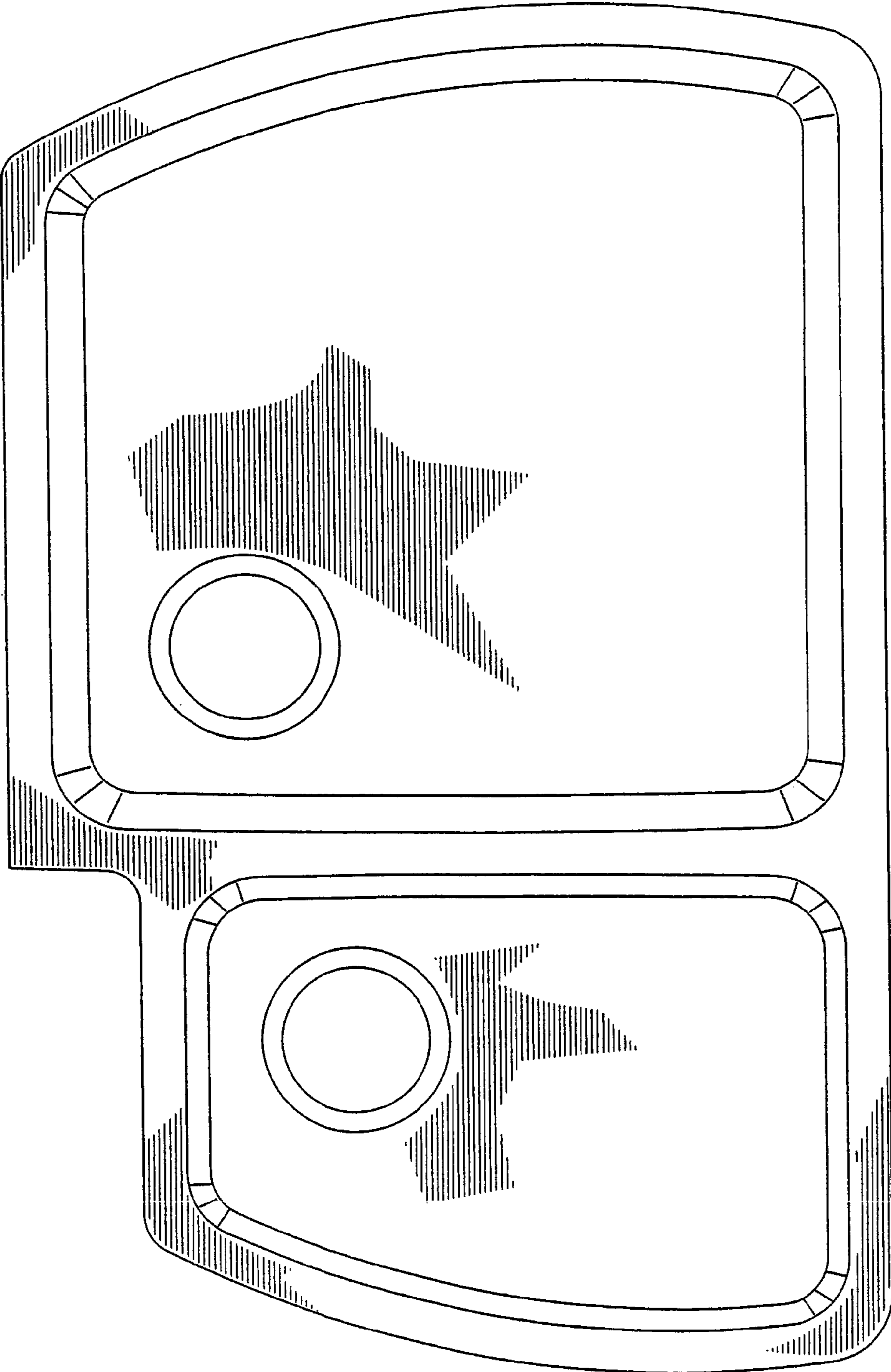

Fig. 3

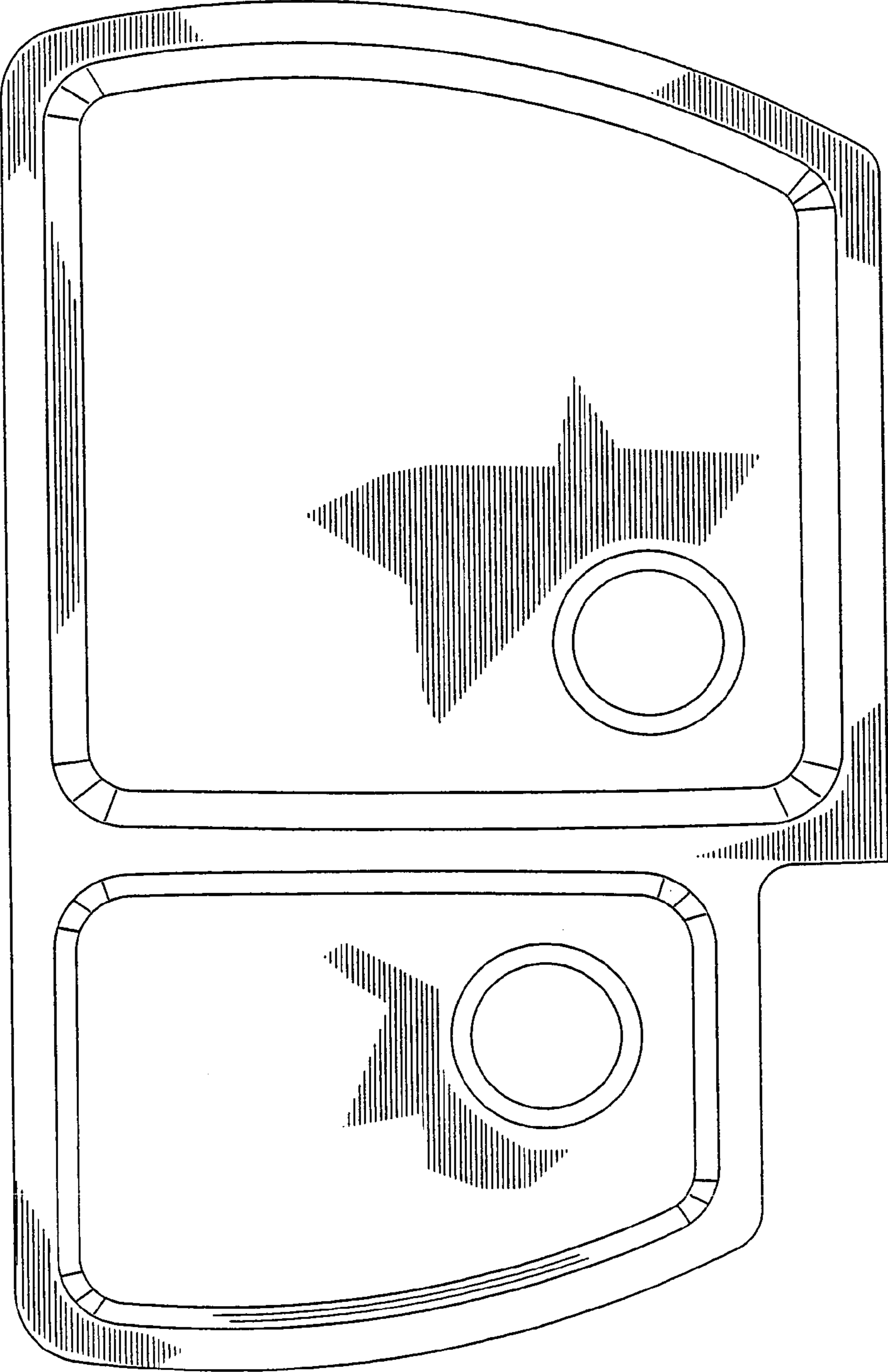

Fig. 4

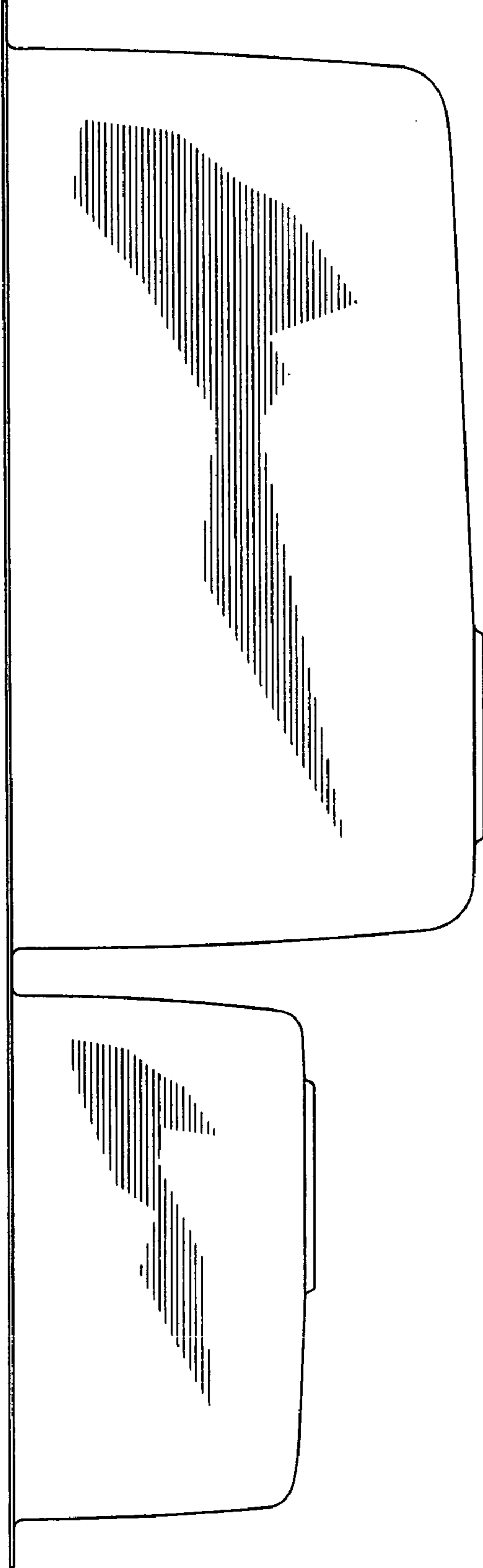

Fig. 5

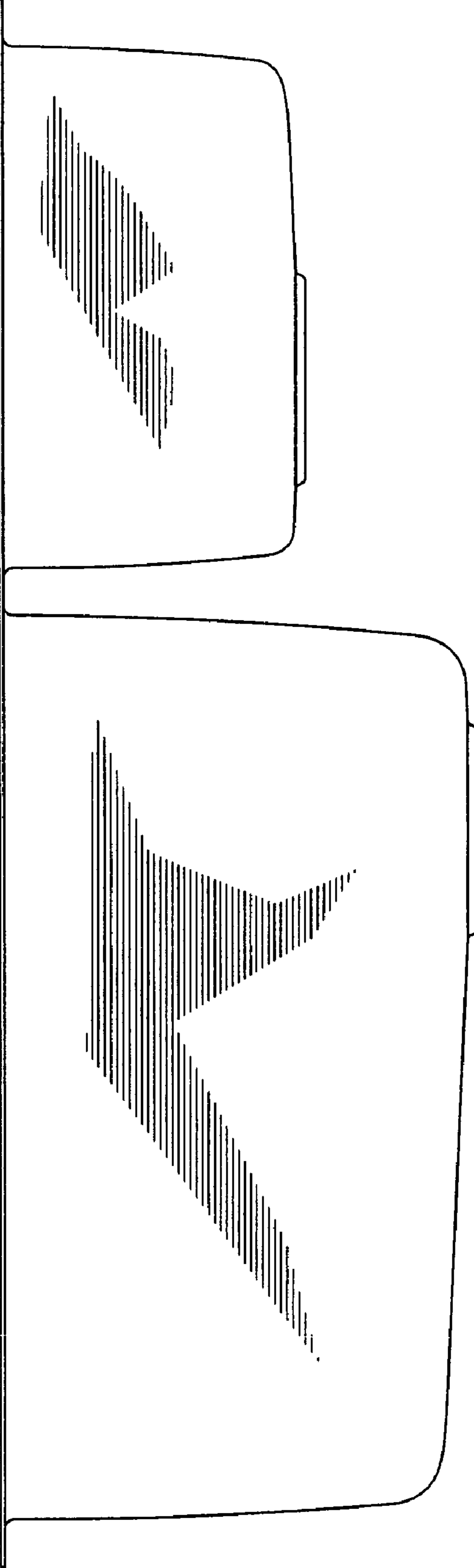

Fig. 6

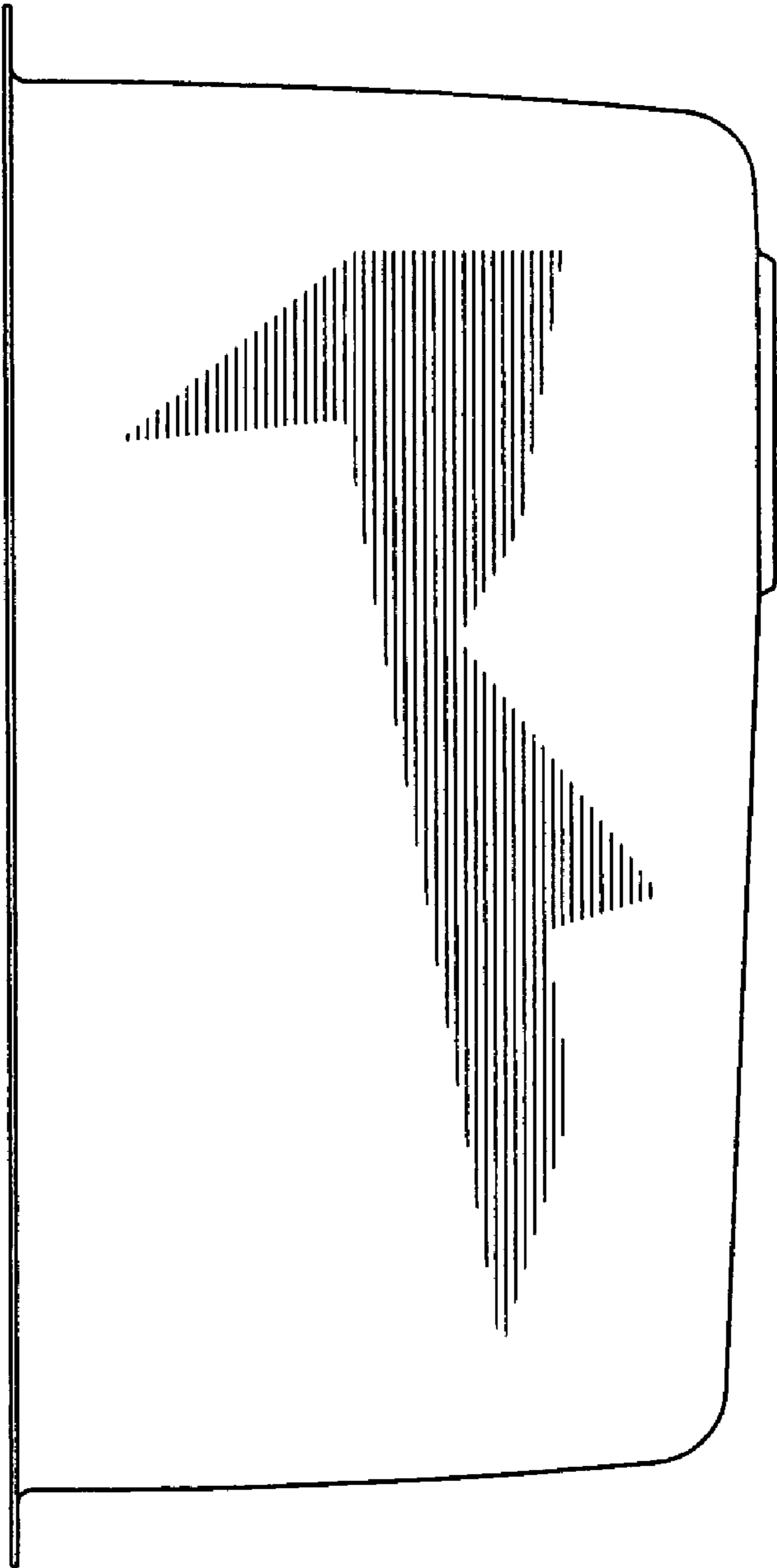

Fig. 7

